



# Series 2000 Garage Door Price List

02.04.2018

**HÖRMANN**



## HÖRMANN IS ALWAYS COMMITTED TO EXCELLENCE: “In Engineering, in User Safety and in Design.”

All our products are third party tested to the highest standards and are certified to the high safety requirements and performance characteristics of the European Standard 13241-1.

This gives you the reassurance that your purchase of a Hörmann product is a safe investment. We are also committed to our national network of Garage Door Specialist Distributors.

These are independent businesses, who believe in customer service and have skills to advise you on the best product for your property, also providing quality fitting and finishing.

**“A great product performs at its best when fitted by experts.”**

### Door Operating Systems

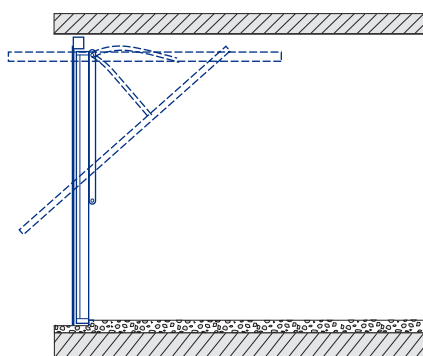

Canopy Operating Gear

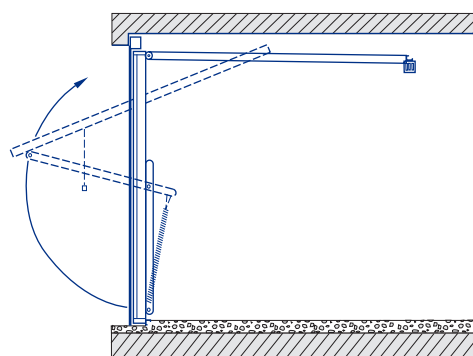

Retractable Operating Gear

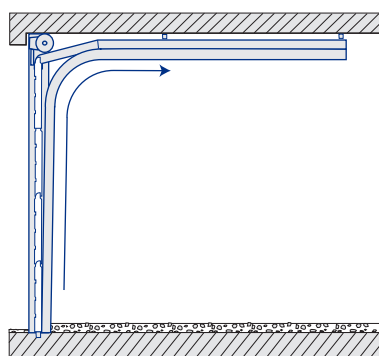



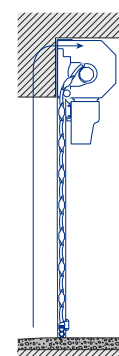



Sectional Operating Gear



RollMatic Operating Gear

# Contents

---





	<b>Up-and-over garage doors</b>	Canopy and retractable with steel infill	2
		Canopy and retractable with timber infill	6
		Canopy and retractable with GRP infill (Glass reinforced polyester)	10
<hr/>			
	<b>Sectional garage doors</b>	Sectional garage doors LTE 42 Single-skinned steel sectional doors	12
		Sectional garage doors LPU 42 Double-skinned steel sectional doors	13
		Optional extras and window designs	16
		Sectional double-leaf side doors	18
	<b>Sectional double-leaf side doors</b>	 Sectional double-leaf side doors with block frames made of aluminium profiles	18
		Vertical ribbed and panelled designs	19
<hr/>			
	<b>RollMatic roller garage doors</b>	RollMatic roller garage doors	20
		RollMatic side doors	24
		RollMatic TDL	25
		RollMatic OD	26
		Garage door operators	30
	<b>Garage door operators</b>	Operator accessories	34
		 CTR 1b-1	34
		CTR 3b-1	34
		CTP 3-1	34
		FIT 2-1 BS	35
		IT 3b-1	35

---



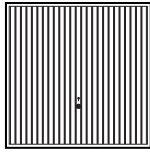
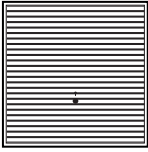

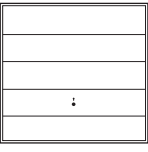
# Hörmann Up-and-Over Doors

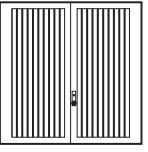
## Canopy & retractable with steel infill

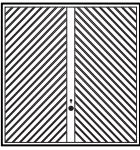

SINGLE DOORS													
Door sizes BR		2001 Vertical		2002 Horizontal		2601 Elegance		2602 Finesse		2101 Ilkley		2103 Caxton	
Imperial	Metric	CAN.	RET.	CAN.	RET.	CAN.	RET.	CAN.	RET.	CAN.	RET.	CAN.	RET.
6'6" x 6'6"	1981 x 1981	638	679	560	601								
7'0"	1981 x 2134	638	679	560	601								
6'10" x 6'4"	2083 x 1930	636	677	574	615								
6'6"	2083 x 1981	636	677	587	628								
7'0"	2083 x 2134	652	693	608	649								
7'0" x 6'4"	2134 x 1930	639 <sup>1</sup>	680 <sup>1</sup>	580	621					1063	1104		
6'6"	<b>2134 x 1981</b>	<b>621<sup>1</sup></b>	<b>662<sup>1</sup></b>	<b>560<sup>1</sup></b>	<b>601<sup>1</sup></b>	<b>787</b>	<b>828</b>	<b>787</b>	<b>828</b>	<b>1063</b>	<b>1104</b>	<b>1026</b>	<b>1067</b>
7'0"	<b>2134 x 2134</b>	<b>644<sup>1</sup></b>	<b>685<sup>1</sup></b>	<b>588<sup>1</sup></b>	<b>629<sup>1</sup></b>	<b>831</b>	<b>872</b>	<b>831</b>	<b>872</b>	<b>1075</b>	<b>1116</b>	<b>1033</b>	<b>1074</b>
7'6"	2134 x 2286		790		737								
7'3" x 6'4"	2210 x 1930	671 <sup>1</sup>	712 <sup>1</sup>	631	672								
6'6"	2210 x 1981	674	715	634	675								
7'0"	2210 x 2134	683	724	641	682								
7'5" x 6'6"	2261 x 1981	679	720	631	672					1104	1145		
7'0"	2261 x 2134	762	803	719	760					1116	1157		
7'6" x 6'4"	2286 x 1930	694	735	631	672					1104	1145		
6'6"	2286 x 1981	694 <sup>1</sup>	735 <sup>1</sup>	631 <sup>1</sup>	672 <sup>1</sup>	873	914	873	914	1104	1145	1086	1127
7'0"	2286 x 2134	762 <sup>1</sup>	803 <sup>1</sup>	721 <sup>1</sup>	762 <sup>1</sup>	1006	1047	1006	1047	1116	1157	1097	1138
7'6"	2286 x 2286		859		883								
7'8" x 6'4"	2337 x 1930	786	827	726	767								
8'0" x 6'4"	2438 x 1930	822	863	727	768					1171	1212		
6'6"	2438 x 1981	822 <sup>1</sup>	863 <sup>1</sup>	727	768	1033	1074	1033	1074	1171	1212	1124	1165
7'0"	2438 x 2134	851 <sup>1</sup>	892 <sup>1</sup>	741	782	1075	1116	1075	1116	1182	1223	1180	1221
7'6"	2438 x 2286		967		860								
8'0"	2438 x 2438		1001		895								
8'6" x 6'6"	2590 x 1981		931		827								
7'0"	2590 x 2134		1009		857								
9'0" x 6'6"	2743 x 1981		1075		1030								
7'0"	2743 x 2134		1174		1081								
10'0" x 6'6"	3048 x 1981		1303		1291								
7'0"	3048 x 2134		1303		1291								
<b>Prices Marked <sup>1</sup> – optional Terra brown RAL 8028 available. Surcharge on door, see page 5.</b>													
DOUBLE DOORS Internal frame sizes BR		2001 Vertical		2002 Horizontal		2601 Elegance		2602 Finesse		2101 Ilkley		Style Not Available	
Imperial	Metric	Retractable		Retractable		Retractable		Retractable		Retractable			
11'0" x 6'6"	3353 x 1981	1416 *		1416 *									
7'0"	3353 x 2134	1427 *		1427 *									
12'0" x 6'6"	3658 x 1981	1487 *		1487 *									
7'0"	3658 x 2134	1498 *		1498 *									
13'0" x 6'6"	3962 x 1981	1619 *		1619 *									
7'0"	3962 x 2134	1654 *		1654 *									
14'0" x 6'6"	4267 x 1981	1559		1559						2158*			
7'0"	4267 x 2134	1559		1559						2158*			
<b>Prices Marked * – Not available ex-stock, delivery 4–5 weeks</b>													
MATCHING SIDE DOORS Ordering sizes		2001 Vertical		2002 Horizontal		2601 Elegance		2602 Finesse		Style Not Available		Style Not Available	
Prices Marked <sup>2</sup> – Not available ex-stock, delivery 4–8 weeks													
875 x 1875		426		890 <sup>2</sup>		832 <sup>2</sup>		832 <sup>2</sup>					
875 x 2000		426		890 <sup>2</sup>		832 <sup>2</sup>		832 <sup>2</sup>					
875 x 2125		426		890 <sup>2</sup>		832 <sup>2</sup>		832 <sup>2</sup>					
1000 x 2000		452		920 <sup>2</sup>		951 <sup>2</sup>		951 <sup>2</sup>					
1000 x 2125		452		920 <sup>2</sup>		951 <sup>2</sup>		951 <sup>2</sup>					



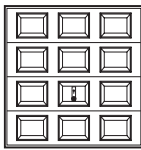

										75mm steel framed doors Recommended structural opening sizes allowing tolerance of 10mm on width & 5mm on height For steel frame options see page 5	
CAN.	RET.	CAN.	RET.	CAN.	RET.	CAN.	RET.	CAN.	RET.	Imperial	Metric
		777	818							7'0" x 6'8½"	2135 x 2044
		789	830							7'0" x 7'2¾"	2135 x 2199
		786	827							7'4" x 6'6½"	2235 x 1994
		787	828							7'4" x 6'8½"	2235 x 2044
		844	885							7'4" x 7'2¾"	2235 x 2199
		787	828							7'6" x 6'6½"	2284 x 1994
<b>663</b>	<b>704</b>	<b>787<sup>1</sup></b>	<b>828<sup>1</sup></b>	<b>1079</b>	<b>1120</b>	<b>787</b>	<b>828</b>	<b>787</b>	<b>828</b>	<b>7'6" x 6'8½"</b>	<b>2284 x 2044</b>
<b>706</b>	<b>747</b>	<b>831<sup>1</sup></b>	<b>872<sup>1</sup></b>	<b>1124</b>	<b>1165</b>	<b>831</b>	<b>872</b>	<b>831</b>	<b>872</b>	<b>7'6" x 7'2¾"</b>	<b>2284 x 2199</b>
										7'6" x 7'8½"	2284 x 2350
		873	914							7'9¼" x 6'6½"	2365 x 1994
										7'9¼" x 6'8½"	2365 x 2044
										7'9¼" x 7'2¾"	2365 x 2199
		873	914							7'11" x 6'8½"	2411 x 2044
		1006	1047							7'11" x 7'2¾"	2411 x 2199
		873	914							8'0" x 6'6½"	2436 x 1994
738	779	873 <sup>1</sup>	914 <sup>1</sup>	1165	1206	873	914			8'0" x 6'8½"	2436 x 2044
		1006 <sup>1</sup>	1047 <sup>1</sup>	1298	1339	1006	1047			8'0" x 7'2¾"	2436 x 2199
										8'0" x 7'8½"	2436 x 2350
		1046	1087							8'2" x 6'6½"	2489 x 1994
		1033	1074							8'6" x 6'6½"	2589 x 1994
926	967	1033	1074			1033	1074			8'6" x 6'8½"	2589 x 2044
964	1005	1075	1116			1075	1116			8'6" x 7'2¾"	2589 x 2199
										8'6" x 7'8½"	2589 x 2350
										8'6" x 8'2¾"	2589 x 2503
										9'0" x 6'8½"	2741 x 2044
										9'0" x 7'2¾"	2741 x 2199
			1356							9'6" x 6'8½"	2894 x 2044
			1380							9'6" x 7'2¾"	2894 x 2199
										10'6" x 6'8½"	3199 x 2044
										10'6" x 7'2¾"	3199 x 2199
2003 Chevron	2004 Georgian	2304 Georgian with windows	2104 Marquess	Style Not Available						Imperial	Metric
Retractable	Retractable	Retractable	Retractable								
										11'6" x 6'8½"	3504 x 2044
										11'6" x 7'2¾"	3504 x 2199
										12'6" x 6'8½"	3809 x 2044
										12'6" x 7'2¾"	3809 x 2199
										13'6" x 6'8½"	4114 x 2044
										13'6" x 7'2¾"	4114 x 2199
2047*	1679	2267*	1679*							14'6" x 6'8½"	4419 x 2044
2047*	1679	2267*	1679*							14'6" x 7'2¾"	4419 x 2199
2003 Chevron	2004 Georgian	2304 Georgian with windows	2104 Marquess	Style Not Available							
1117 <sup>2</sup>	832 <sup>2</sup>	967 <sup>2</sup>	832 <sup>2</sup>								
1117 <sup>2</sup>	832 <sup>2</sup>	967 <sup>2</sup>	832 <sup>2</sup>								
1117 <sup>2</sup>	832 <sup>2</sup>	967 <sup>2</sup>	832 <sup>2</sup>								
1134 <sup>2</sup>	951 <sup>2</sup>	1086 <sup>2</sup>	951 <sup>2</sup>								
1134 <sup>2</sup>	951 <sup>2</sup>	1086 <sup>2</sup>	951 <sup>2</sup>								

# Hörmann Up-and-Over Doors

## Canopy & retractable with steel infill

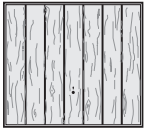
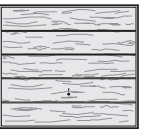

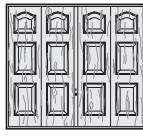
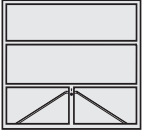
SINGLE DOORS											
Door sizes BR		Vertical Decograin Golden Oak or Rosewood		Horizontal Decograin Golden Oak or Rosewood		Georgian Decograin Golden Oak or Rosewood		Marquess Decograin Golden Oak or Rosewood		2011 Open for infill	
Imperial	Metric	CAN.	RET.	CAN.	RET.	CAN.	RET.	CAN.	RET.	CAN.	RET.
6'6" x 6'6"	1981 x 1981									540	581
7'0"	1981 x 2134									540	581
6'10" x 6'4"	2083 x 1930									540	581
6'6"	2083 x 1981										
7'0"	2083 x 2134										
7'0" x 6'4"	2134 x 1930									540	581
6'6"	<b>2134 x 1981</b>	<b>799</b>	<b>840</b>	<b>711</b>	<b>752</b>	<b>941</b>	<b>982</b>	<b>941</b>	<b>982</b>	540	581
7'0"	<b>2134 x 2134</b>	<b>822</b>	<b>863</b>	<b>769</b>	<b>810</b>	<b>986</b>	<b>1027</b>	<b>986</b>	<b>1027</b>	574	615
7'6"	2134 x 2286										
7'3" x 6'4"	2210 x 1930									600	641
6'6"	2210 x 1981										
7'0"	2210 x 2134										
7'5" x 6'6"	2261 x 1981	852	893	787	828					600	641
7'0"	2261 x 2134	917	958	876	917					618	659
7'6" x 6'4"	2286 x 1930									600	641
6'6"	2286 x 1981	852	893	787	828	1228	1269	1046	1087	600	641
7'0"	2286 x 2134	917	958	876	917	<b>1271</b>	<b>1312</b>	1208	1249	617	658
7'6"	2286 x 2286										
7'8" x 6'4"	2337 x 1930									627	668
8'0" x 6'4"	2438 x 1930									627	668
6'6"	2438 x 1981	980	1021	868	909	1228	1269	1228	1269	627	668
7'0"	2438 x 2134	1009	1050	900	941	1271	1312	1271	1312	627	668
7'6"	2438 x 2286										
8'0"	2438 x 2438										
8'6" x 6'6"	2590 x 1981										
7'0"	2590 x 2134										
9'0" x 6'6"	2743 x 1981										736
7'0"	2743 x 2134										748
10'0" x 6'6"	3048 x 1981										909
7'0"	3048 x 2134										909
DOUBLE DOORS Internal frame sizes BR		Style Not Available		Style Not Available		Style Not Available		Style Not Available		2011 Open for infill	
Imperial	Metric									Retractable	
11'0" x 6'6"	3353 x 1981										1794
7'0"	3353 x 2134										1874
12'0" x 6'6"	3658 x 1981										1900
7'0"	3658 x 2134										1971
13'0" x 6'6"	3962 x 1981										1994
7'0"	3962 x 2134										2058
14'0" x 6'6"	4267 x 1981										1863
7'0"	4267 x 2134										1863
<b>Prices Marked * – Not available ex-stock, delivery 4–5 weeks</b>											
MATCHING SIDE DOORS Ordering sizes		2001 Golden Oak or Rosewood		2002 Golden Oak or Rosewood		2004 Golden Oak or Rosewood		2104 Golden Oak or Rosewood		2011 Open for infill	
<b>Prices Marked <sup>2</sup> – Not available ex-stock, delivery 4–8 weeks</b>											
875 x 1875		924 <sup>2</sup>		924 <sup>2</sup>		924 <sup>2</sup>		924 <sup>2</sup>		426	
875 x 2000		929 <sup>2</sup>		929 <sup>2</sup>		929 <sup>2</sup>		929 <sup>2</sup>		426	
875 x 2125		935 <sup>2</sup>		935 <sup>2</sup>		935 <sup>2</sup>		935 <sup>2</sup>		426	
1000 x 2000		1062 <sup>2</sup>		1062 <sup>2</sup>		1062 <sup>2</sup>		1062 <sup>2</sup>		452	
1000 x 2125		1069 <sup>2</sup>		1069 <sup>2</sup>		1069 <sup>2</sup>		1069 <sup>2</sup>		452	



The door leaf and optional box section steel frame are made of galvanised material that is polyester powder coated on both sides.

This finish is extremely durable and the standard colour is Traffic white RAL 9016.

Other colours are available listed in optional extras below.

To help maintain the aesthetic appearance of your door and prevent the build up of dirt, salt and other corrosive substances the door should be washed with a mild soap-based solution on a regular basis.

If the door is located near the coast it is important that the door panel and frame should be washed at least every 2 months.

We also suggest that all other components are brushed down on a regular basis to prevent the build up of dirt and dust etc.

The window frames on the Georgian and Ilkley doors are UPVC and white as standard.

These frames are a 2-part construction with the window material sandwiched between and frames screwed together from the back for security.

The finish of the Decograin doors is a synthetic foil-coated timber design outside (inside primer white).

The leaf frame and fixing frame is a matching powder coating.





**For further choice of exciting door designs in steel, traditional or contemporary, with a vast range of sizes and increased range of colours, ask your garage door specialist about the N 80 Up-and-Over garage doors available to special order.**

Optional extras for Steel Doors	Price
<b>75mm</b> Steel fixing frame for either canopy or retractable geared single doors. Factory fitted	<b>116</b>
<b>75mm</b> Steel fixing frame for either canopy or retractable geared single doors. Factory fitted with frame to compliment Decograin	<b>116</b>
<b>75mm</b> Steel fixing frame for <b>DOUBLE</b> retractable geared doors, when ordered with the door	<b>183</b>
<b>60mm</b> Steel fixing frame for canopy geared doors only. Factory fitted	<b>120</b>
<b>60mm</b> Steel fixing frame for canopy geared doors only. Factory fitted with frame to compliment Decograin	<b>120</b>
<b>Please note:</b> Factory fitted 8' high frame not available	
Prices marked <sup>1</sup> – optional Terra Brown RAL 8028 available. Surcharge on door	<b>32</b>
Retractable plus gear for retractable doors up to 7'6" wide giving extra drive through width	
Surcharge on retractable price	<b>60</b>
4 point locking kit for extra security, factory fit with door order or retrofit – single door sizes only	<b>54</b>
3 point locking kit for extra security, factory fit with door (this cannot be retrofitted). Available for 2001 side doors only	<b>94</b>
Window options for 2304 Georgian style door – Plain, crossed or diamond style with crystal glazing	<b>Incl.</b>
<b>Colours are available to special order in the following styles:</b>	
2001 Vertical, 2002 Horizontal, 2101 Ilkley available in all the listed sizes	
2004 Georgian, 2304 Georgian with windows and 2104 Marquess are available in 7066, 7070, 7566, 7570, 7666, 7670 and 8066, 8070 sizes only	
<b>Please note:</b> Caxton, Chevron, Elegance, Finesse and Countess steel up-and-over doors are only available in white	
<b>Colours:</b>	
Terra Brown RAL 8028, Signal Blue RAL 5005, Steel Blue RAL 5011, Moss Green RAL 6005, Ruby Red RAL 3003, Jet Black RAL 9005	
Includes matching frame if ordered with door. White frame RAL 9016 also available, please specify when ordering	
Please allow 5-6 weeks lead time for coloured doors	
	Single doors <b>110</b>
	Double doors <b>177</b>
<b>Please consult your Hörmann dealer for steel garage door styles that are available from stock in colours: Anthracite grey RAL 7016, Jet black RAL 9005, Moss green RAL 6005 and Steel blue RAL 5011</b>	
<b>Coloured window frames for Georgian and Ilkley doors:</b>	
Coloured window frames to match door colour	
Georgian doors (price per window, see note below for the number of windows)	<b>33</b>
Ilkley doors (price per single door)	<b>154</b>
Ilkley doors (price per double door)	<b>308</b>
Please state coloured windows required on order	
Orders received without reference will be supplied with white as standard	
Georgian doors up to 10' wide = 4 windows, 11' to 13' = 6 windows, 14' = 8 windows	
<b>Optional handle sets</b>	
Cast Aluminium silver colour and brass colour	<b>138</b>
Cast Aluminium white and brown	<b>162</b>
Brushed or polished stainless steel	<b>196</b>
Matching lever handles are also available for side doors	<b>P.O.A.</b>

# Hörmann Up-and-Over Doors



## Canopy & retractable with timber infill

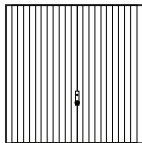

SINGLE DOORS											
Door sizes BR		2005 Measham		2007 Jacobean		2008 Tudor		2014 Rutland		2009 Vertical or Horizontal	
Imperial	Metric	CAN.	RET.	CAN.	RET.	CAN.	RET.	CAN.	RET.	CAN.	RET.
6'6" x 6'6"	1981 x 1981	1148	1189	1384	1425	1384	1425	1384	1425	1579	1620
7'0"	1981 x 2134	1148	1189	1384	1425	1384	1425	1384	1425	1579	1620
6'10" x 6'4"	2083 x 1930	1148	1189	1384	1425	1384	1425	1384	1425	1579	1620
6'6"	2083 x 1981										
7'0"	2083 x 2134										
7'5" x 6'4"	2134 x 1930	1148	1189	1384	1425	1384	1425	1384	1425	1579	1620
6'6"	<b>2134 x 1981</b>	<b>1148</b>	<b>1189</b>	<b>1384</b>	<b>1425</b>	<b>1384</b>	<b>1425</b>	<b>1384</b>	<b>1425</b>	<b>1579</b>	<b>1620</b>
7'0"	<b>2134 x 2134</b>	<b>1148</b>	<b>1189</b>	<b>1384</b>	<b>1425</b>	<b>1384</b>	<b>1425</b>	<b>1384</b>	<b>1425</b>	<b>1579</b>	<b>1620</b>
7'6"	2134 x 2286										
7'3" x 6'4"	2210 x 1930	1193	1234	1449	1490	1449	1490	1449	1490	1637	1678
6'6"	2210 x 1981										
7'0"	2210 x 2134										
7'5" x 6'6"	2261 x 1981	1193	1234	1449	1490	1449	1490	1449	1490	1637	1678
7'0"	2261 x 2134	1283	1324	1495	1536	1495	1536	1495	1536	1675	1716
7'6" x 6'4"	2286 x 1930	1193	1234	1449	1490	1449	1490	1449	1490	1637	1678
6'6"	2286 x 1981	1193	1234	1449	1490	1449	1490	1449	1490	1637	1678
7'0"	2286 x 2134	1221	1262	1495	1536	1495	1536	1495	1536	1675	1716
7'6"	2286 x 2286										
8'0"	2286 x 2438										
7'8" x 6'4"	2337 x 1930	1239	1280	1513	1554	1513	1554	1513	1554	1637	1678
8'0" x 6'4"	2438 x 1930	1260	1301	1530	1571	1530	1571	1530	1571	1731	1772
6'6"	2438 x 1981	1260	1301	1530	1571	1530	1571	1530	1571	1731	1772
7'0"	2438 x 2134	1286	1327	1568	1609	1568	1609	1568	1609	1781	1822
8'0"	2438 x 2438										
8'6" x 6'6"	2590 x 1981										
7'0"	2590 x 2134										
9'0" x 6'6"	2743 x 1981		1524		1767		1767		1767		1886
7'0"	2743 x 2134		1524		1767		1767		1767		1886
10'0" x 6'6"	3048 x 1981		1529		1887		1887		1887		1972
7'0"	3048 x 2134		1529		1887		1887		1887		1972
DOUBLE DOORS		2005 Measham		2007 Jacobean		2008 Tudor		2014 Rutland		2009 Vertical or Horizontal	
Internal frame sizes BR		2005 Measham		2007 Jacobean		2008 Tudor		2014 Rutland		2009 Vertical or Horizontal	
Imperial	Metric	CAN.	RET.	CAN.	RET.	CAN.	RET.	CAN.	RET.	CAN.	RET.
11'0" x 6'6"	3353 x 1981		2697		2975		2975		2975		3178
7'0"	3353 x 2134		2697		2975		2975		2975		3178
12'0" x 6'6"	3658 x 1981		2799		2990		2990		2990		3513
7'0"	3658 x 2134		2799		2990		2990		2990		3513
13'0" x 6'6"	3962 x 1981		2810		3225		3225		3225		3927
7'0"	3962 x 2134		2810		3225		3225		3225		3927
14'0" x 6'6"	4267 x 1981		2815		3174		3174		3174		3290
7'0"	4267 x 2134		2815		3174		3174		3174		3290
<b>Please note: Lead times on all timber garage doors will be 5 to 6 weeks</b>											
MATCHING SIDE DOORS		2005 Measham		2007 Jacobean		2008 Tudor		2014 Rutland		2009 Vertical or Horizontal	
Ordering sizes		2005 Measham		2007 Jacobean		2008 Tudor		2014 Rutland		2009 Vertical or Horizontal	
<b>Please note: Lead times on all timber side garage doors will be 5 to 6 weeks</b>											
875 x 1875			773		895		895		895		905
875 x 2000			773		895		895		895		905
875 x 2125			773		895		895		895		905
1000 x 2000			813		932		932		932		946
1000 x 2125			813		932		932		932		946



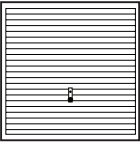

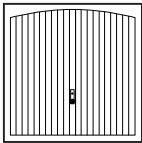
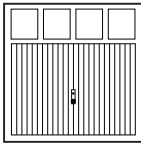

										75mm steel framed doors Recommended structural opening sizes allowing tolerance of 10mm on width & 5mm on height For steel frame options see page 9	
CAN.	RET.	CAN.	RET.	CAN.	RET.	CAN.	RET.	CAN.	RET.	Imperial	Metric
1576	1617	1829	1870	1829	1870	1829	1870	1889	1930	7'0" x 6'8½"	2135 x 2044
1576	1617	1829	1870	1829	1870	1829	1870	1889	1930	7'0" x 7'2¾"	2135 x 2199
1576	1617	1829	1870	1829	1870	1829	1870	1889	1930	7'4" x 6'6½"	2235 x 1994
										7'4" x 6'8½"	2235 x 2044
										7'4" x 7'2¾"	2235 x 2199
1576	1617	1829	1870	1829	1870	1829	1870	1889	1930	7'6" x 6'6½"	2284 x 1994
<b>1576</b>	<b>1617</b>	<b>1829</b>	<b>1870</b>	<b>1829</b>	<b>1870</b>	<b>1829</b>	<b>1870</b>	<b>1889</b>	<b>1930</b>	<b>7'6" x 6'8½"</b>	<b>2284 x 2044</b>
<b>1576</b>	<b>1617</b>	<b>1829</b>	<b>1870</b>	<b>1829</b>	<b>1870</b>	<b>1829</b>	<b>1870</b>	<b>1889</b>	<b>1930</b>	<b>7'6" x 7'2¾"</b>	<b>2284 x 2199</b>
										7'6" x 7'8½"	2284 x 2350
1637	1678	1887	1928	1887	1928	1887	1928	1972	2013	7'9¼" x 6'6½"	2365 x 1994
										7'9¼" x 6'8½"	2365 x 2044
										7'9¼" x 7'2¾"	2365 x 2199
1637	1678	1887	1928	1887	1928	1887	1928	1972	2013	7'11" x 6'8½"	2411 x 2044
1698	1739	1917	1958	1917	1958	1917	1958	2022	2063	7'11" x 7'2¾"	2411 x 2199
1637	1678	1887	1928	1887	1928	1887	1928	1972	2013	8'0" x 6'6½"	2436 x 1994
1637	1678	1887	1928	1887	1928	1887	1928	1972	2013	8'0" x 6'8½"	2436 x 2044
1698	1739	1917	1958	1917	1958	1917	1958	2064	2105	8'0" x 7'2¾"	2436 x 2199
										8'0" x 7'8½"	2436 x 2350
										8'0" x 8'2¾"	2436 x 2503
1800	1841	2068	2109	2068	2109	2068	2109	2212	2253	8'2" x 6'6½"	2489 x 1994
1800	1841	2068	2109	2068	2109	2068	2109	2212	2253	8'6" x 6'6½"	2589 x 1994
1800	1841	2068	2109	2068	2109	2068	2109	2212	2253	8'6" x 6'8½"	2589 x 2044
1800	1841	2068	2109	2068	2109	2068	2109	2212	2253	8'6" x 7'2¾"	2589 x 2199
										8'6" x 8'2¾"	2589 x 2503
										9'0" x 6'8½"	2741 x 2044
										9'0" x 7'2¾"	2741 x 2199
	2072		2364		2364		2364		2429	9'6" x 6'8½"	2894 x 2044
	2072		2364		2364		2364		2429	9'6" x 7'2¾"	2894 x 2199
	2259		2516		2516		2516		2700	10'6" x 6'8½"	3199 x 2044
	2259		2516		2516		2516		2700	10'6" x 7'2¾"	3199 x 2199
<b>2109 Mallory</b>		<b>2013 Caxton</b>		<b>2020 Gatcombe</b>		<b>2114 Shepshed</b>		<b>2019 Garage Light</b>		Imperial	Metric
CAN.	RET.	CAN.	RET.	CAN.	RET.	CAN.	RET.	CAN.	RET.		
	3343		3530		3530		3530		3929	11'6" x 6'8½"	3504 x 2044
	3343		3530		3530		3530		3929	11'6" x 7'2¾"	3504 x 2199
	3626		3838		3838		3838		4322	12'6" x 6'8½"	3809 x 2044
	3626		3838		3838		3838		4322	12'6" x 7'2¾"	3809 x 2199
	3934		4194		4194		4194		4867	13'6" x 6'8½"	4114 x 2044
	3934		4194		4194		4194		4867	13'6" x 7'2¾"	4114 x 2199
	3821		4079		4079		4079		4612	14'6" x 6'8½"	4419 x 2044
	3821		4079		4079		4079		4612	14'6" x 7'2¾"	4419 x 2199
<b>2109 Mallory</b>		<b>2013 Caxton</b>		<b>2020 Gatcombe</b>		<b>2114 Shepshed</b>		<b>2019 Garage Light</b>			
CAN.	RET.	CAN.	RET.	CAN.	RET.	CAN.	RET.	CAN.	RET.		
	1020		1056		1078		1050		1203		
	1020		1056		1078		1050		1203		
	1020		1056		1078		1050		1203		
	1062		1097		1120		1090		1240		
	1062		1097		1120		1090		1240		

# Hörmann Up-and-Over Doors

## Canopy & retractable with timber infill

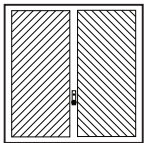
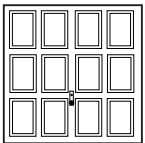

SINGLE DOORS										75mm steel framed doors Recommended structural opening sizes allowing tolerance of 10mm on width & 5mm on height For steel frame options see page 9	
Door sizes BR		2119 Leicester		2010 Chevron		2121 Chesterfield		2122 Middleton		Imperial	Metric
Imperial	Metric	CAN.	RET.	CAN.	RET.	CAN.	RET.	CAN.	RET.	Imperial	Metric
6'6" x 6'6"	1981 x 1981		2180	1952	1993		2491		2470	7'0" x 6'8½"	2135 x 2044
7'0"	1981 x 2134		2180	1952	1993		2491		2470	7'0" x 7'2¾"	2135 x 2199
6'10" x 6'4"	2083 x 1930		2180	1952	1993		2491		2470	7'4" x 6'6½"	2235 x 1994
6'6"	2083 x 1981									7'4" x 6'8½"	2235 x 2044
7'0"	2083 x 2134									7'4" x 7'2¾"	2235 x 2199
7'0" x 6'4"	2134 x 1930		2196	1952	1993		2491		2470	7'6" x 6'6½"	2284 x 1994
6'6"	2134 x 1981		2196	1952	1993		2491		2470	7'6" x 6'8½"	2284 x 2044
7'0"	2134 x 2134		2196	1952	1993		2508		2499	7'6" x 7'2¾"	2284 x 2199
7'6"	2134 x 2286									7'6" x 7'8½"	2284 x 2350
7'3" x 6'4"	2210 x 1930		2395	2039	2080		2674		2666	7'9¼" x 6'6½"	2365 x 1994
6'6"	2210 x 1981									7'9¼" x 6'8½"	2365 x 2044
7'0"	2210 x 2134									7'9¼" x 7'2¾"	2365 x 2199
7'5" x 6'6"	2261 x 1981		2406	2039	2080		2679		2666	7'11" x 6'8½"	2411 x 2044
7'0"	2261 x 2134		2499	2095	2136		2691		2679	7'11" x 7'2¾"	2411 x 2199
7'6" x 6'4"	2286 x 1930		2404	2039	2080		2679		2666	8'0" x 6'6½"	2436 x 1994
6'6"	2286 x 1981		2404	2039	2080		2679		2666	8'0" x 6'8½"	2436 x 2044
7'0"	2286 x 2134		2499	2095	2136		2705		2691	8'0" x 7'2¾"	2436 x 2199
7'6"	2286 x 2286									8'0" x 7'8½"	2436 x 2350
8'0"	2286 x 2438									8'2" x 6'6½"	2436 x 2503
7'8" x 6'4"	2337 x 1930		2564	2227	2268					8'6" x 6'6½"	2489 x 1994
8'0" x 6'4"	2438 x 1930		2573	2227	2268					8'6" x 6'8½"	2589 x 1994
6'6"	2438 x 1981		2573	2227	2268					8'6" x 7'2¾"	2589 x 2044
7'0"	2438 x 2134		2630	2263	2304					8'6" x 7'8½"	2589 x 2199
8'0"	2438 x 2438									8'6" x 8'2¾"	2589 x 2503
8'6" x 6'6"	2590 x 1981									9'0" x 6'8½"	2741 x 2044
7'0"	2590 x 2134									9'0" x 7'2¾"	2741 x 2199
9'0" x 6'6"	2743 x 1981		2696		2452					9'6" x 6'8½"	2894 x 2044
7'0"	2743 x 2134		2696		2452					9'6" x 7'2¾"	2894 x 2199
10'0" x 6'6"	3048 x 1981		3037		2855					10'6" x 6'8½"	3199 x 2044
7'0"	3048 x 2134		3037		2855					10'6" x 7'2¾"	3199 x 2199
DOUBLE DOORS Internal Frame Sizes BR		2119 Leicester		2010 Chevron		Style Not Available		Style Not Available		Imperial	Metric
BR	RET.	CAN.	RET.	CAN.	RET.	CAN.	RET.	CAN.	RET.	Imperial	Metric
11'0" x 6'6"	3353 x 1981		4233		4051					11'6" x 6'8½"	3504 x 2044
7'0"	3353 x 2134		4233		4051					11'6" x 7'2¾"	3504 x 2199
12'0" x 6'6"	3658 x 1981		4526		4126					12'6" x 6'8½"	3809 x 2044
7'0"	3658 x 2134		4526		4126					12'6" x 7'2¾"	3809 x 2199
13'0" x 6'6"	3962 x 1981		4953		4194					13'6" x 6'8½"	4114 x 2044
7'0"	3962 x 2134		4953		4194					13'6" x 7'2¾"	4114 x 2199
14'0" x 6'6"	4267 x 1981		4832		4079					14'6" x 6'8½"	4419 x 2044
7'0"	4267 x 2134		4832		4079					14'6" x 7'2¾"	4419 x 2199
<b>Please note: Lead times on all timber garage doors will be 5 to 6 weeks</b>											
MATCHING SIDE DOORS Ordering Sizes		2119 Leicester		2010 Chevron		2121 Chesterfield		2122 Middleton		Imperial	Metric
BR	RET.	CAN.	RET.	CAN.	RET.	CAN.	RET.	CAN.	RET.	Imperial	Metric
875 x 1875			921		895		895		921		
875 x 2000			921		895		895		921		
875 x 2125			921		895		895		921		
1000 x 2000			946		932		932		946		
1000 x 2125			946		932		932		946		



Our timber garage doors are constructed as an infill to fit into the Open-for-Infill Up-and-Over door frame, this gives the doors their rigid and durable construction.

The styles Measham, Jacobean, Tudor and Rutland are cedar facings glued and fixed to exterior quality plywood.

The solid cedar doors are 12mm tongue and groove boards constructed as an infill.

Cedar is organically grown with natural colour and grain variations; this is a feature of cedar.

We make every effort to harmonise the effect where possible, by hand matching the component parts used in construction.

Please note a uniform overall grain pattern cannot be guaranteed.

#### Protection (Basecoat)

All our timber doors are supplied with a dip immersion coat of Remmers Induline GW306 base stain primer 006 Light Oak; this coating is for temporary protection only.

If purchased in this temporary finish, please ensure that a full specification of finishing coats are applied immediately before or after installation to all exposed surfaces - inside as well as outside - with a Remmers or similar finishing coat system.

**A fully finished option is available, please see options below.**

**For further choice of exciting door designs, traditional or contemporary in Nordic Pine and Hemlock, with a vast range of sizes, ask your garage door specialist about the N80 Up-and-Over garage doors available to special order.**

Optional extras for timber doors	Price
<b>75mm</b> Steel fixing frame for either canopy or retractable geared single doors, factory fitted Terra brown RAL 8028 as standard	<b>116</b>
<b>75mm</b> Steel fixing frame for <b>DOUBLE</b> retractable geared doors Terra brown RAL 8028 as standard when ordered with the door	<b>183</b>
<b>60mm</b> Steel fixing frame for canopy geared doors only, factory fitted Terra brown RAL 8028 as standard	<b>120</b>
<b>Please note:</b> Factory fitted 8' high frame not available	
Retractable plus gear for retractable doors up to 7'6" wide giving extra drive through width Surcharge on retractable price	<b>60</b>
4 point locking kit for extra security, factory fit with door order or retrofit	<b>54</b>
Window options for 2019 Garage Light door - Crystal or clear glazing and can be plain or with square or diamond simulated leading	<b>Incl.</b>

#### Fully finished option

This is available as a factory process giving a 5 year erosion protection

The product used is Remmers and is available in the following stain colours:

Mahogany, Walnut, Dark Oak, Medium Oak, Light Oak, Teak, Ebony, Rosewood and Golden Oak

For south facing situations exposed to strong sunlight, the dark colours are NOT recommended as they can store excessive heat and dry out

	Stain finish	Traffic white RAL 9016	RAL to choose
Door sizes up to 8'0" x 7'0"	<b>118</b>	<b>203</b>	<b>270</b>
Door sizes up to 14'0" x 7'0"	<b>270</b>	<b>365</b>	<b>670</b>
Side Doors	<b>87</b>	<b>183</b>	<b>229</b>



#### Optional handle sets

Cast Aluminium silver colour and brass colour	<b>138</b>
Cast Aluminium white and brown	<b>162</b>
Brushed or polished stainless steel	<b>196</b>
Matching lever handles are also available for side doors	<b>P.O.A.</b>

# Hörmann Up-and-Over Doors

## Canopy & retractable with GRP infill

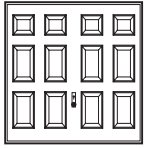

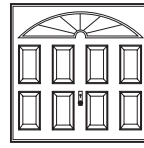
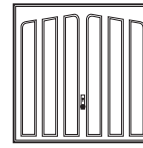
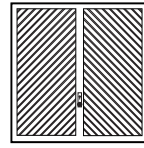
SINGLE DOORS											
Door sizes BR		2042 Windermere		2041 Coniston		2044 Stamford		2034 Penshurst		2035 Hartfield	
Imperial	Metric	CAN.	RET.	CAN.	RET.	CAN.	RET.	CAN.	RET.	CAN.	RET.
7'0" x 6'6"	2134 x 1981	1888	1929	1848	1889	1939	1980	2001	2042	2001	2042
7'0"	2134 x 2134	1888	1929	1848	1889	1939	1980	2001	2042	2001	2042
7'6" x 6'6"	2286 x 1981	2001	2042	1951	1992	2041	2082	2175	2216	2175	2216
7'0"	2286 x 2134	2001	2042	1951	1992	2041	2082	2175	2216	2175	2216
8'0" x 6'6"	2438 x 1981	2152	2193	2129	2170	2209	2250	2316	2357		
7'0"	2438 x 2134	2152	2193	2129	2170	2209	2250	2316	2357		
9'0" x 6'6"	2743 x 1981		2415*		2360*		2438*		2485		
7'0"	2743 x 2134		2415*		2360*		2438*		2485		

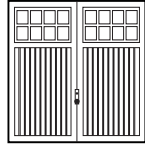
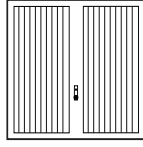
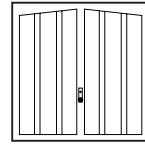
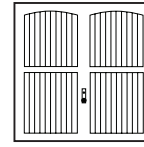
SINGLE DOORS & DOUBLE DOORS									
Door sizes BR		2040 Livingston		2047 Bourton		2048 Burford		2049 Moreton	
Imperial	Metric	CAN.	RET.	CAN.	RET.	CAN.	RET.	CAN.	RET.
7'0" x 6'6"	2134 x 1981	2212	2253	2001	2042	2001	2042	2212	2253
7'0"	2134 x 2134	2212	2253	2001	2042	2001	2042	2212	2253
7'6" x 6'6"	2286 x 1981	2388	2429	2175	2216	2175	2216	2388	2429
7'0"	2286 x 2134	2388	2429	2175	2216	2175	2216	2388	2429
8'0" x 6'6"	2438 x 1981			2316	2357	2316	2357	2526	2567
7'0"	2438 x 2134			2316	2357	2316	2357	2526	2567
14'0" x 6'6"	4267 x 1981				3657		3969		3985
7'0"	4267 x 2134				3657		3969		3985

Coniston and Stamford are supplied in white RAL 9016 OFI, all other styles are supplied in Terra brown RAL 8028 OFI.

75mm steel framed doors			
Door sizes BR		Recommended structural opening sizes allowing tolerance of 10mm on width & 5mm on height	
Imperial	Metric	Imperial	Metric
7'0" x 6'6"	2134 x 1981	7'6" x 6'8½"	2284 x 2044
7'0" x 7'0"	2134 x 2134	7'6" x 7'2¾"	2284 x 2199
7'6" x 6'6"	2286 x 1981	8'0" x 6'8½"	2436 x 2044
7'6" x 7'0"	2286 x 2134	8'0" x 7'2¾"	2436 x 2199
8'0" x 6'6"	2438 x 1981	8'6" x 6'8½"	2589 x 2044
8'0" x 7'0"	2438 x 2134	8'6" x 7'2¾"	2589 x 2199
9'0" x 6'6"	2743 x 1981	9'6" x 6'8½"	2894 x 2044
9'0" x 7'0"	2743 x 2134	9'6" x 7'2¾"	2894 x 2199

For GRP colour options please consult main brochure

Window Options	Price
Clear or translucent	Per door 185
Clear or translucent with decorative leading	Per door 310

Windows are available in the Windermere and Coniston (clear or translucent) Stamford comes with black windows as standard  
\* Doors only available without handle (automation required)



## Door sizes

Large range of standard sizes is supplemented with intermediate widths and heights available by modification at Hörmann's UK headquarters. Please consult with your Hörmann UK specialist installer.

## NT60 double-leaf aluminium side doors



Vertical ribbed and panelled designs

## Secured by design

- LPU 42 sectional doors are certified SBD when fitted with a ProMatic or SupraMatic BiSecur operator
- A unique mechanical latch, integral to the operator boom engages automatically to make the door impossible to lever open
- Doors with windows and ventilation grilles, manually operated doors, or doors fitted between the opening are excluded from SBD certification
- Copies of SBD and test certification are available, if required, via the Hörmann UK Marketing Department

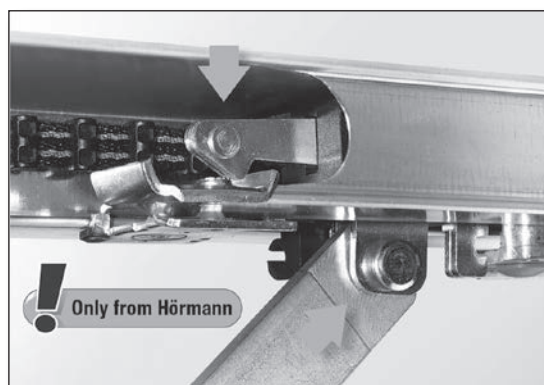

**For further information on Secured by Design see our brochure.**





# Hörmann Sectional Doors

## LTE 42 – single-skinned doors with steel sections

Single doors with Z track tension springs giving low headroom as standard

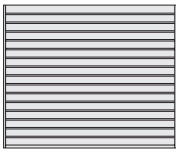

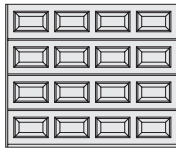
SINGLE DOORS								No. of panels
Door sizes BR		S-ribbed Woodgrain		M-ribbed Woodgrain		S-panelled Woodgrain		
Imperial	Metric	Outside White	Outside Colour	Outside White	Outside Colour	Outside White	Outside Colour	
6'10" x 6'2"	2080 x 1875	778	954	778	954	872	1048	4
6'10"	2080 x 2080	815	1010	815	1010	905	1100	4
7'0" x 6'6"	2134 x 2000	795	988	795	988	889	1082	4
7'0"	2134 x 2125	815	1020	815	1020	905	1110	4
7'6" x 6'6"	2286 x 2000	795	1001	795	1001	889	1095	4
7'0"	2286 x 2125	815	1034	815	1034	905	1124	4
7'4"	2286 x 2250	858	1090	858	1090	942	1174	4
7'9"	2286 x 2375	993	1238	993	1238	1087	1332	4
8'2"	2286 x 2500	991	1249	991	1249	1082	1340	4
8'0" x 6'6"	2438 x 2000	828	1048	828	1048	922	1142	4
7'0"	2438 x 2125	856	1090	856	1090	938	1172	4
7'4"	2438 x 2250	900	1147	900	1147	978	1225	4
7'9"	2438 x 2375	1032	1293	1032	1293	1118	1379	4
8'2"	2438 x 2500	1030	1305	1030	1305	1117	1392	4
8'6" x 6'6"	2591 x 2000	828	1062	828	1062	922	1156	4
7'0"	2591 x 2125	856	1104	856	1104	938	1186	4
9'0" x 6'6"	2740 x 2000	932	1179	932	1179	1069	1316	4
7'0"	2740 x 2125	960	1223	960	1223	1088	1351	4
9'6" x 6'6"	2896 x 2000	963	1224	963	1224	1122	1383	5
7'0"	2896 x 2125	998	1275	998	1275	1138	1415	5
10'0" x 6'6"	3048 x 2000	963	1238	963	1238	1122	1397	5
7'0"	3048 x 2125	998	1290	998	1290	1138	1430	5

For information on outside colour, see page 15

## Double doors with N track torsion springs (for low headroom see bottom of page 15)

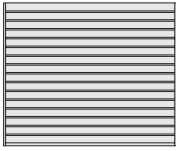
DOUBLE DOORS			
Door sizes BR		S-ribbed Woodgrain	
Imperial	Metric	Outside White	Outside Colour
11'0" x 6'6"	3353 x 2000	1343	1645
7'0"	3353 x 2125	1391	1712
12'0" x 6'6"	3658 x 2000	1487	1817
7'0"	3658 x 2125	1547	1897
13'0" x 6'6"	3962 x 2000	1518	1875
7'0"	3962 x 2125	1578	1957
14'0" x 6'6"	4267 x 2000	1646	2031
7'0"	4267 x 2125	1732	2141
14'6" x 6'6"	4420 x 2000	1681	2079
7'0"	4420 x 2125	1771	2194
15'0" x 6'6"	4572 x 2000	1692	2104
7'0"	4572 x 2125	1777	2215
15'6" x 6'6"	4725 x 2000	1742	2168
7'0"	4725 x 2125	1829	2281
16'0" x 6'6"	4877 x 2000	1740	2179
7'0"	4877 x 2125	1829	2296





For door width and glazing configuration - please refer to the 01-18 A

# Hörmann Sectional Doors

## LPU 42 – double-skinned doors with steel sections – 42mm

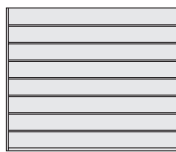

Single doors with Z track tension springs giving low headroom as standard



SINGLE DOORS									
Door sizes BR		S-ribbed Woodgrain/ M-ribbed Woodgrain		M-ribbed Sandgrain		M-ribbed Silkgrain		M-ribbed Decograin	
Imperial	Metric	Outside White	Outside Colour	Outside White	Anthracite grey Terra brown White aluminium	Outside White	Outside Colour	Rosewood, Golden Oak, Dark Oak, Winchester Oak, Night Oak	
6'10" x 6'2"	2080 x 1875	905	1081	962	1138	1104	1280	1213	
6'6"	2080 x 2000	946	1134	1009	1197	1159	1347	1272	
6'10"	2080 x 2080	980	1175	1047	1242	1202	1397	1320	
7'0" x 6'6"	2134 x 2000	979	1172	1009	1202	1159	1352	1272	
7'0"	2134 x 2125	1013	1218	1047	1252	1202	1407	1320	
7'6" x 6'6"	2286 x 2000	979	1185	1009	1215	1159	1365	1272	
7'0"	2286 x 2125	1013	1232	1047	1266	1202	1421	1320	
7'4"	2286 x 2250	1026	1258	1096	1328	1260	1492	1384	
7'9"	2286 x 2375	1106	1351	1144	1389	1314	1559	1445	
8'2"	2286 x 2500	1103	1361	1186	1444	1365	1623	1501	
8'0" x 6'6"	2438 x 2000	1029	1249	1064	1284	1225	1445	1348	
7'0"	2438 x 2125	1068	1302	1109	1343	1277	1511	1405	
7'4"	2438 x 2250	1076	1323	1144	1391	1315	1562	1446	
7'9"	2438 x 2375	1157	1418	1195	1456	1376	1637	1515	
8'2"	2438 x 2500	1153	1428	1246	1521	1438	1713	1584	
8'6" x 6'6"	2591 x 2000	1029	1263	1064	1298	1225	1459	1348	
7'0"	2591 x 2125	1068	1316	1109	1357	1277	1525	1405	
9'0" x 6'6"	2740 x 2000	1112	1359	1159	1406	1341	1588	1479	
7'0"	2740 x 2125	1149	1412	1204	1467	1393	1656	1537	
9'6" x 6'6"	2896 x 2000	1162	1423	1217	1478	1412	1673	1559	
7'0"	2896 x 2125	1207	1484	1266	1543	1467	1744	1620	
10'0" x 6'6"	3048 x 2000	1123	1398	1217	1492	1412	1687	1559	
7'0"	3048 x 2125	1161	1453	1266	1558	1467	1759	1620	

For information on outside colour, see page 15

## Double doors with N track torsion springs (for low headroom see bottom of page 15)

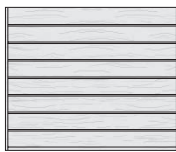
SINGLE DOORS									
Door sizes BR		S-ribbed Woodgrain/ M-ribbed Woodgrain		M-ribbed Sandgrain		M-ribbed Silkgrain		M-ribbed Decograin	
Imperial	Metric	Outside White	Outside Colour	Outside White	Anthracite grey Terra brown White aluminium	Outside White	Outside Colour	Rosewood, Golden Oak, Dark Oak, Winchester Oak, Night Oak	
11'0" x 6'6"	3353 x 2000	1322	1624	1442	1744	1684	1986	1867	
7'0"	3353 x 2125	1372	1693	1498	1819	1749	2070	1940	
12'0" x 6'6"	3658 x 2000	1550	1880	1620	1950	1898	2228	2110	
7'0"	3658 x 2125	1607	1957	1683	2033	1971	2321	2192	
13'0" x 6'6"	3962 x 2000	1606	1963	1667	2024	1955	2312	2174	
7'0"	3962 x 2125	1666	2045	1727	2106	2027	2406	2255	
14'0" x 6'6"	4267 x 2000	1665	2050	1714	2099	2013	2398	2240	
7'0"	4267 x 2125	1730	2139	1782	2191	2092	2501	2329	
14'6" x 6'6"	4420 x 2000	1720	2118	1756	2154	2064	2462	2298	
7'0"	4420 x 2125	1787	2210	1827	2250	2145	2568	2389	
15'0" x 6'6"	4572 x 2000	1750	2162	1770	2182	2079	2491	2315	
7'0"	4572 x 2125	1818	2256	1843	2281	2166	2604	2413	
15'6" x 6'6"	4725 x 2000	1826	2252	1801	2227	2120	2546	2361	
7'0"	4725 x 2125	1896	2348	1872	2324	2201	2653	2453	
16'0" x 6'6"	4877 x 2000	1826	2265	1834	2273	2156	2595	2402	
7'0"	4877 x 2125	1896	2363	1905	2372	2241	2708	2497	



Intermediate sizes are available, please see your dealer for more details

# Hörmann Sectional Doors

## LPU 42 – double-skinned doors with steel sections – 42mm

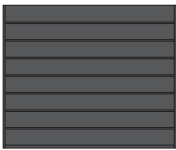

Single doors with Z track tension springs giving low headroom as standard

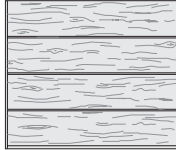

SINGLE DOORS		 <b>M-ribbed Titan Metallic CH 703</b>	 <b>L-ribbed Sandgrain</b>	 <b>L-ribbed Silkgrain / Micrograin</b>		 <b>L-ribbed Deco grain</b>		
Door sizes BR				Anthracite grey Terra brown White aluminium	Outside White		Outside Colour	Rosewood, Golden Oak, Dark Oak, Winchester Oak, Night Oak
Imperial	Metric							
6'10" x 6'2"	2080 x 1875	1213	1139	1315	1261	1437	1381	
6'6"	2080 x 2000	1272	1171	1359	1296	1484	1418	
6'10"	2080 x 2080	1320	1186	1381	1311	1506	1434	
7'0" x 6'6"	2134 x 2000	1272	1171	1364	1296	1489	1418	
7'0"	2134 x 2125	1320	1186	1391	1311	1516	1434	
7'6" x 6'6"	2286 x 2000	1272	1171	1377	1296	1502	1418	
7'0"	2286 x 2125	1320	1186	1405	1311	1530	1434	
7'4"	2286 x 2250	1384	1236	1468	1369	1601	1498	
7'9"	2286 x 2375	1445	1243	1488	1375	1620	1503	
8'2"	2286 x 2500	1501	1276	1534	1409	1667	1540	
8'0" x 6'6"	2438 x 2000	1348	1235	1455	1368	1588	1499	
7'0"	2438 x 2125	1405	1257	1491	1393	1627	1526	
7'4"	2438 x 2250	1446	1319	1566	1462	1709	1602	
7'9"	2438 x 2375	1515	1354	1615	1501	1762	1644	
8'2"	2438 x 2500	1584	1391	1666	1541	1816	1688	
8'6" x 6'6"	2591 x 2000	1348	1235	1469	1368	1602	1499	
7'0"	2591 x 2125	1405	1257	1505	1393	1641	1526	
9'0" x 6'6"	2740 x 2000	1479	1353	1600	1503	1750	1650	
7'0"	2740 x 2125	1537	1371	1634	1523	1786	1672	
9'6" x 6'6"	2896 x 2000	1559	1424	1685	1585	1846	1743	
7'0"	2896 x 2125	1620	1445	1722	1608	1885	1767	
10'0" x 6'6"	3048 x 2000	1559	1424	1699	1585	1860	1743	
7'0"	3048 x 2125	1620	1445	1737	1608	1900	1767	

For information on outside colour, see page 15

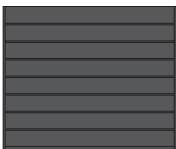
## Double doors with N track torsion springs (for low headroom see bottom of page 15)

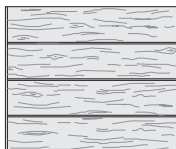
DOUBLE DOORS		 <b>M-ribbed Titan Metallic CH 703</b>	 <b>L-ribbed Sandgrain</b>	 <b>L-ribbed Silkgrain / Micrograin</b>		 <b>L-ribbed Deco grain</b>		
Door sizes BR				Anthracite grey Terra brown White aluminium	Outside White		Outside Colour	Rosewood, Golden Oak, Dark Oak, Winchester Oak, Night Oak
Imperial	Metric							
11'0" x 6'6"	3353 x 2000	1867	1684	1986	1881	2183	2075	
7'0"	3353 x 2125	1940	1709	2030	1909	2230	2105	
12'0" x 6'6"	3658 x 2000	2110	1897	2227	2125	2455	2349	
7'0"	3658 x 2125	2192	1930	2280	2162	2512	2390	
13'0" x 6'6"	3962 x 2000	2174	1954	2311	2193	2550	2425	
7'0"	3962 x 2125	2255	1983	2362	2222	2601	2457	
14'0" x 6'6"	4267 x 2000	2240	2012	2397	2259	2644	2500	
7'0"	4267 x 2125	2329	2045	2454	2295	2704	2539	
14'6" x 6'6"	4420 x 2000	2298	2068	2466	2321	2719	2569	
7'0"	4420 x 2125	2389	2100	2523	2356	2779	2608	
15'0" x 6'6"	4572 x 2000	2315	2089	2501	2346	2758	2597	
7'0"	4572 x 2125	2413	2122	2560	2383	2821	2638	
15'6" x 6'6"	4725 x 2000	2361	2126	2552	2389	2815	2645	
7'0"	4725 x 2125	2453	2162	2614	2429	2881	2689	
16'0" x 6'6"	4877 x 2000	2402	2164	2603	2431	2870	2692	
7'0"	4877 x 2125	2497	2201	2668	2473	2940	2739	

Intermediate sizes are available, please see your dealer for more details



# Hörmann Sectional Doors

## LPU 42 – double-skinned doors with steel sections – 42mm

Single doors with Z track tension springs giving low headroom as standard

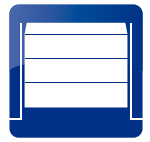

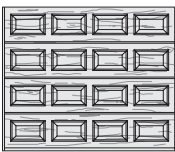
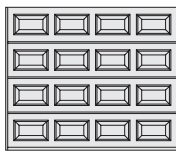
SINGLE DOORS		 <b>L-ribbed Titan Metallic CH 703</b>	 <b>S-panelled Decograin</b> Rosewood, Golden Oak, Dark Oak, Winchester Oak, Night Oak	No. of panels	 <b>S-panelled Woodgrain</b>		No. of panels
Door sizes BR					Outside White	Outside Colour	
Imperial	Metric						
6'10" x 6'2"	2080 x 1875	<b>1381</b>	<b>1483</b>	4	<b>1136</b>	<b>1312</b>	4
6'6"	2080 x 2000	<b>1418</b>	<b>1516</b>	4	<b>1191</b>	<b>1379</b>	4
6'10"	2080 x 2080	<b>1434</b>			<b>1204</b>	<b>1399</b>	4
7'0" x 6'6"	2134 x 2000	<b>1418</b>	<b>1516</b>	4	<b>1231</b>	<b>1424</b>	4
7'0"	2134 x 2125	<b>1434</b>	<b>1533</b>	4	<b>1246</b>	<b>1451</b>	4
7'6" x 6'6"	2286 x 2000	<b>1418</b>	<b>1516</b>	4	<b>1231</b>	<b>1437</b>	4
7'0"	2286 x 2125	<b>1434</b>	<b>1533</b>	4	<b>1246</b>	<b>1465</b>	4
7'4"	2286 x 2250	<b>1498</b>	<b>1672</b>	4	<b>1244</b>	<b>1476</b>	4
7'9"	2286 x 2375	<b>1503</b>	<b>1710</b>	4	<b>1330</b>	<b>1575</b>	4
8'2"	2286 x 2500	<b>1540</b>	<b>1770</b>	4	<b>1326</b>	<b>1584</b>	4
8'0" x 6'6"	2438 x 2000	<b>1499</b>	<b>1608</b>	4	<b>1300</b>	<b>1520</b>	4
7'0"	2438 x 2125	<b>1526</b>	<b>1629</b>	4	<b>1317</b>	<b>1551</b>	4
7'4"	2438 x 2250	<b>1602</b>	<b>1837</b>	4	<b>1311</b>	<b>1558</b>	4
7'9"	2438 x 2375	<b>1644</b>	<b>1864</b>	4	<b>1397</b>	<b>1658</b>	4
8'2"	2438 x 2500	<b>1688</b>	<b>1898</b>	4	<b>1394</b>	<b>1669</b>	4
8'6" x 6'6"	2591 x 2000	<b>1499</b>	<b>1608</b>	4	<b>1300</b>	<b>1534</b>	4
7'0"	2591 x 2125	<b>1526</b>	<b>1629</b>	4	<b>1317</b>	<b>1565</b>	4
9'0" x 6'6"	2740 x 2000	<b>1650</b>	<b>1763</b>	4	<b>1411</b>	<b>1658</b>	4
7'0"	2740 x 2125	<b>1672</b>	<b>1792</b>	4	<b>1431</b>	<b>1694</b>	4
9'6" x 6'6"	2896 x 2000	<b>1743</b>	<b>1860</b>	5	<b>1481</b>	<b>1742</b>	5
7'0"	2896 x 2125	<b>1767</b>	<b>1891</b>	5	<b>1509</b>	<b>1786</b>	5
10'0" x 6'6"	3048 x 2000	<b>1743</b>	<b>1860</b>	5	<b>1422</b>	<b>1697</b>	5
7'0"	3048 x 2125	<b>1767</b>	<b>1891</b>	5	<b>1451</b>	<b>1743</b>	5

For information on outside colour, see below

All coloured doors are special order only – 4 to 8 weeks delivery. Please note: the prices listed as Outside Colour are for the following RAL colours only: RAL 1015, 3003, 5011, 5014, 6005, 6009, 7016, 7030, 7035, 7040, 8001, 8003, 8028, 9005, 9006 and 9007. Special RAL colours are available, please ask your garage door specialist.

**Double doors with N track torsion springs (for low headroom see bottom of page)**

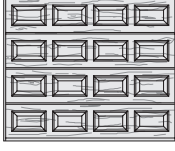
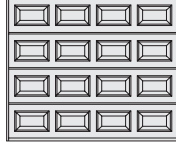
DOUBLE DOORS		 <b>L-ribbed Titan Metallic CH 703</b>	 <b>S-panelled Decograin</b> Rosewood, Golden Oak, Dark Oak, Winchester Oak, Night Oak	No. of panels	 <b>S-panelled Woodgrain</b>		No. of panels
Door sizes BR					Outside White	Outside Colour	
Imperial	Metric						
11'0" x 6'6"	3353 x 2000	<b>2075</b>	<b>2210</b>	5	<b>1695</b>	<b>1997</b>	5
7'0"	3353 x 2125	<b>2105</b>	<b>2246</b>	5	<b>1725</b>	<b>2046</b>	5
12'0" x 6'6"	3658 x 2000	<b>2349</b>	<b>2498</b>	6	<b>1997</b>	<b>2327</b>	6
7'0"	3658 x 2125	<b>2390</b>	<b>2540</b>	6	<b>2028</b>	<b>2378</b>	6
13'0" x 6'6"	3962 x 2000	<b>2425</b>	<b>2579</b>	6	<b>2075</b>	<b>2432</b>	6
7'0"	3962 x 2125	<b>2457</b>	<b>2615</b>	6	<b>2103</b>	<b>2482</b>	6
14'0" x 6'6"	4267 x 2000	<b>2500</b>	<b>2658</b>	7	<b>2158</b>	<b>2543</b>	7
7'0"	4267 x 2125	<b>2539</b>	<b>2698</b>	7	<b>2190</b>	<b>2599</b>	7
14'6" x 6'6"	4420 x 2000	<b>2569</b>	<b>2729</b>	7	<b>2235</b>	<b>2633</b>	7
7'0"	4420 x 2125	<b>2608</b>	<b>2772</b>	7	<b>2272</b>	<b>2695</b>	7
15'0" x 6'6"	4572 x 2000	<b>2597</b>	<b>2761</b>	7	<b>2275</b>	<b>2687</b>	7
7'0"	4572 x 2125	<b>2638</b>	<b>2803</b>	7	<b>2313</b>	<b>2751</b>	7
15'6" x 6'6"	4725 x 2000	<b>2645</b>	<b>2816</b>	7	<b>2386</b>	<b>2812</b>	7
7'0"	4725 x 2125	<b>2689</b>	<b>2856</b>	7	<b>2422</b>	<b>2874</b>	7
16'0" x 6'6"	4877 x 2000	<b>2692</b>	<b>2866</b>	7	<b>2386</b>	<b>2825</b>	7
7'0"	4877 x 2125	<b>2739</b>	<b>2912</b>	7	<b>2422</b>	<b>2889</b>	7

### Low headroom

Door with track application L, torsion spring at the back

127

Intermediate sizes are available, please see your dealer for more details

# Hörmann Sectional Doors

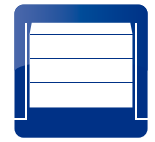

## Optional extras for sectional doors

Colour surcharge		Price
RAL to choose colours (please ask to see colour chart)		per m <sup>2</sup> <b>62</b>
Door leaf in special colours (please ask to see colour chart)		per m <sup>2</sup> <b>124</b>
Fittings	Article no.	£
	Profile half cylinder 30 + 10 mm, keys to pass, for garage door handle sets	3091459 Each <b>31</b>

The below listed handle sets are supplied with:

- Lock with profile half cylinder with side locking
- Template for lock knock-out on site

A factory lock knock-out will result in a longer delivery time and must be ordered explicitly (State position on order!)

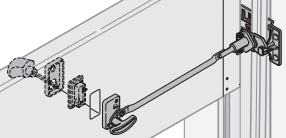
	Door handle set, black plastic, prepared for profile cylinder	4015100	Each	<b>57</b>
	Door handle set, silver finish cast aluminium (F2), prepared for profile cylinder	3060829	Each	<b>140</b>
	Door handle set, cast aluminium RAL 9016, prepared for profile cylinder	3060831	Each	<b>160</b>
	Door handle set, brown cast aluminium, prepared for profile cylinder	3076054	Each	<b>160</b>
	Door handle set, brushed stainless steel, prepared for profile cylinder	3060835	Each	<b>160</b>

Emergency release		Price
Emergency release for sectional doors <b>with</b> handle set (Please state at point of order)		Each <b>44</b>
Emergency release for sectional doors <b>without</b> handle set (Please state at point of order)		Each <b>43</b>
Special anchor set		Price
Set of 8 special anchors for between wall fitting		per set <b>51</b>
ThermoFrame – Frame support with thermal break		Price
ThermoFrame set		£

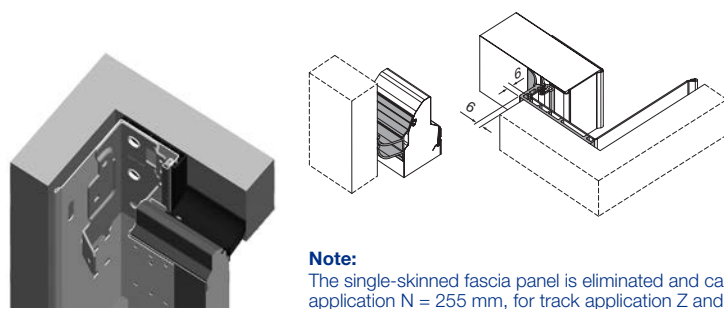

### Set consists of:

- **Lintel seal (1 unit)**  
With 2 lip seals
- **Plastic angle profiles (2 units)**  
Black, 84 × 22.5 mm with lip seal (frame covering may be needed to match the colour)

### Note:

The single-skinned fascia panel is eliminated and cannot be fitted. Headroom required for track application N = 255 mm, for track application Z and L = 145 mm.

Please also note the supplements and limitations in the technical manual!

<b>ThermoFrame set 1</b> Article no. 4004702	RM height ≤ 3000 mm LZ width ≤ 3250 mm	Plastic angle profiles Length 3210 mm Lintel seal Length 3250 mm	Each	<b>249</b>
<b>ThermoFrame set 2</b> Article no. 4006087	RM height ≤ 3000 mm LZ width > 3250 mm and ≤ 6000 mm	Plastic angle profiles Length 3210 mm Lintel seal Length 6000 mm	Each	<b>296</b>
<b>ThermoFrame set 3</b> Article no. 4004982	For doors with track application H	Plastic angle profiles Length 4500 mm Lintel seal Length 5500 mm	Each	<b>296</b>

Door heights	Frame cover profiles matching the colour of the door – 55mm × 19.5mm and 90mm × 19.5mm: prices are per pair																	
	White RAL 9016						Colour						RAL to choose/CH 703				Decograin/Titan Metallic CH 703	
	Woodgrain		Sandgrain		Silkgrain		Woodgrain		Sandgrain		Silkgrain		Woodgrain		Silkgrain		Titan Metallic CH 703	
1875mm	55	74	59	81	59	81	66	98	75	102	75	102	92	135	98	145	83	109
2000mm	58	78	62	86	62	86	70	104	80	108	80	108	98	144	104	154	88	116
2080mm	61	82	65	90	65	90	73	109	84	113	84	113	102	150	109	161	92	121
2125mm	62	83	66	92	66	92	75	111	85	115	85	115	105	153	111	164	94	124
2250mm	66	88	70	97	70	97	79	117	90	122	90	122	111	162	117	174	99	131
2375mm	69	93	74	103	74	103	84	124	95	129	95	129	117	171	124	183	105	138
2500mm	73	98	78	108	78	108	88	130	100	135	100	135	123	180	130	193	110	145

Silkgrain white / Titan Metallic CH 703 and Decograin colours are available ex-stock. Please note colours and RAL to choose/CH 703 must be ordered with the door.

Sandgrain is available in RAL 9016, 7016, 8028 and 9006

Renovation fascias										
Door heights	White RAL 9016						RAL to choose/CH 703			Decograin/Titan Metallic CH 703
	Woodgrain		Sandgrain		Silkgrain		Woodgrain		Silkgrain	
	156	169	169	193	206	206	218	231	178	
Set: Renovation fascias to cover damaged brickwork edges consisting of: 3 angle sections, 69/40mm, each 3000mm long										
<b>Price</b>	<b>156</b>	<b>169</b>	<b>169</b>	<b>193</b>	<b>206</b>	<b>206</b>	<b>218</b>	<b>231</b>	<b>178</b>	
Set: Fascia frame -95- consisting of: 2 fascias, 95mm, 2800mm long, 1 fascia 95mm, 3200mm long, fixing material										
<b>Price</b>	<b>181</b>	<b>192</b>	<b>192</b>	<b>218</b>	<b>229</b>	<b>229</b>	<b>243</b>	<b>254</b>	<b>198</b>	













# Hörmann Sectional Doors

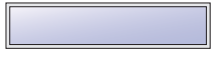

## Glazing options for sectional doors

LTE 42 with 3mm single pane in clear (FK) or crystal structure (KR), 3mm  
 LTE 42 ribbed doors are only available with type D glazing  
 LPU 42 with 16mm (for panelled) or 22mm (for ribbed) double pane in clear (DS) or crystal structure (DK)

LTE 42 panelled doors are available in S glazing only  
 LTE 42 doors are not available with M0 & L0 glazing

Glazings		£/each
<b>S0</b>	 With synthetic single pane, 3 mm, clear or crystal structure	LTE 42 <b>91</b>
	With synthetic double pane, 16 mm or 22mm, clear / clear or crystal structure / crystal structure	LPU 42 <b>97</b>
<b>S1</b>	 With synthetic single pane, 3 mm, clear or crystal structure	LTE 42 <b>109</b>
	With synthetic double pane, 16 mm or 22mm, clear / clear or crystal structure / crystal structure	LPU 42 <b>119</b>
<b>S2</b>	 With synthetic single pane, 3 mm, clear or crystal structure	LTE 42 <b>109</b>
	With synthetic double pane, 16 mm or 22mm, clear / clear or crystal structure / crystal structure	LPU 42 <b>119</b>
<b>S 10 – S 60</b>	 With synthetic single pane, 3 mm, clear or crystal structure	LTE 42 <b>115</b>
	With synthetic double pane, 16 mm or 22mm, clear / clear or crystal structure / crystal structure	LPU 42 <b>123</b>
<b>M0</b>	 <ul style="list-style-type: none"> <li>With synthetic double pane, 22mm</li> <li>Clear / clear or crystal structure / crystal structure</li> </ul> <p>For door width and glazing configuration, please refer to the 01-18 A price list</p>	LPU 42 <b>117</b>
<b>L0</b>	 <ul style="list-style-type: none"> <li>With synthetic double pane, 22mm</li> <li>Clear / clear or crystal structure / crystal structure</li> </ul> <p>For door width and glazing configuration, please refer to the 01-18 A price list</p>	LPU 42 <b>153</b>
<b>Type D</b>	 <ul style="list-style-type: none"> <li>With clear synthetic pane or crystal structure, 3 mm</li> <li>With synthetic double pane, clear / clear or crystal structure / crystal structure, 16 mm</li> </ul> <p>For door width and glazing configuration, please refer to the 01-18 A price list</p>	LTE 42 <b>85</b> LPU 42 <b>101</b>
Sunrise Glazing		£/section
<b>S 10</b>	 <ul style="list-style-type: none"> <li>With synthetic single pane, 3 mm</li> <li>Clear or crystal structure</li> </ul> <p>For LTE 42 (4 × £115)</p>	<b>460</b>
	<p><b>LTE 42</b> Door width 2075 mm up to 2740 mm</p> <p><b>LPU 42</b> Door width 2130 mm up to 2750 mm</p>	For LPU 42 (4 × £123) <b>492</b>
<b>S 20</b>	 <ul style="list-style-type: none"> <li>With synthetic single pane, 3 mm</li> <li>Clear or crystal structure</li> </ul> <p>For LTE 42 (5 × £115)</p>	<b>575</b>
	<p><b>LTE 42</b> Door width 2745 mm up to 3000 mm</p> <p><b>LPU 42</b> Door width 2755 mm up to 3500 mm</p>	For LPU 42 (5 × £123) <b>615</b>
<b>S 30</b>	 <ul style="list-style-type: none"> <li>With synthetic double pane, 16 mm or 22mm</li> <li>Clear / clear or crystal structure / crystal structure</li> </ul> <p>For LPU 42 (6 × £123)</p>	<b>738</b>
<b>LPU 42</b>	Door width 3505 mm up to 4000 mm	
<b>S 40</b>	 <ul style="list-style-type: none"> <li>With synthetic double pane, 16 mm or 22mm</li> <li>Clear / clear or crystal structure / crystal structure</li> </ul> <p>For LPU 42 (7 × £123)</p>	<b>861</b>
<b>LPU 42</b>	Door width 4005 mm up to 4750 mm	
<b>S 50</b>	 <ul style="list-style-type: none"> <li>With synthetic double pane, 16 mm or 22mm</li> <li>Clear / clear or crystal structure / crystal structure</li> </ul> <p>For LPU 42 (8 × 123)</p>	<b>984</b>
<b>LPU 42</b>	Door width 4755 mm up to 5500 mm	
<b>S 60</b>	 <ul style="list-style-type: none"> <li>With synthetic double pane, 16 mm or 22mm</li> <li>Clear / clear or crystal structure / crystal structure</li> </ul> <p>For LPU 42 (8 × £123)</p>	<b>984</b>
<b>LPU 42</b>	Door width 4755 mm up to 5500 mm	
Standard Colour Surcharges for the above windows. Please note: front window frame only is painted		Price
Standard colour or colour for Decograin	For glazing S0, S1, S2, M0, L0 & type D	Each <b>26</b>
	For Sunrise glazing × No. of frames for width of door	Each <b>33</b>
RAL to choose	For glazing S0, S1, S2, M0, L0 & type D	Each <b>46</b>
	For Sunrise glazing × No. of frames for width of door	Each <b>57</b>













# NT 60 Aluminium Garage Side Doors

Double-leaf side doors with block frame made of aluminium profiles; door infill made of steel sectional door sections



## Size range, ribbed, profile type 2

For an overview of dimensions and optional extras, please see your dealer for more details

Size range										
<b>Ordering sizes</b> Overall frame dimensions (RAM)	<b>S-ribbed</b> <b>Woodgrain</b>		<b>M-ribbed</b> <b>Woodgrain</b>		<b>M-ribbed</b> <b>Sandgrain<sup>1)</sup></b>		<b>M-ribbed</b> <b>Silkgrain</b>		<b>M-ribbed</b> <b>Decograin<sup>2)</sup></b>	
Width x Height	Exterior White	Exterior Color	Exterior White	Exterior Color	Exterior White	Exterior Color	Exterior White	Exterior Color	Exterior <b>Timber design / Titan Metallic CH 703</b>	
<b>Fitting in the opening – opening outwards</b>										
From 1330 x 1960										
to 1800 x 2250	<b>2281</b>	<b>2611</b>	<b>2281</b>	<b>2611</b>	<b>2367</b>	<b>2697</b>	<b>2441</b>	<b>2771</b>	<b>2666</b>	
to 2200 x 2100	<b>2320</b>	<b>2650</b>	<b>2320</b>	<b>2650</b>	<b>2407</b>	<b>2737</b>	<b>2483</b>	<b>2813</b>	<b>2714</b>	
to 2500 x 2558	<b>2361</b>	<b>2691</b>	<b>2361</b>	<b>2691</b>	<b>2450</b>	<b>2780</b>	<b>2528</b>	<b>2858</b>	<b>2761</b>	
Size range										
<b>Ordering sizes</b> Overall frame dimensions (RAM)	<b>L-ribbed</b> <b>Woodgrain</b>		<b>L-ribbed</b> <b>Sandgrain<sup>1)</sup></b>		<b>L-ribbed</b> <b>Silkgrain</b>		<b>L-ribbed</b> <b>Micrograin</b>		<b>L-ribbed</b> <b>Decograin<sup>2)</sup></b>	
Width x Height	Exterior White	Exterior Color	Exterior White	Exterior Color	Exterior White	Exterior Color	Exterior White	Exterior Color	Exterior <b>Timber design / Titan Metallic CH 703</b>	
<b>Fitting in the opening – opening outwards</b>										
From 1330 x 1960										
to 1800 x 2250	<b>2357</b>	<b>2687</b>	<b>2448</b>	<b>2778</b>	<b>2523</b>	<b>2853</b>	<b>2523</b>	<b>2853</b>	<b>2757</b>	
to 2200 x 2100	<b>2398</b>	<b>2728</b>	<b>2491</b>	<b>2821</b>	<b>2566</b>	<b>2896</b>	<b>2566</b>	<b>2896</b>	<b>2806</b>	
to 2500 x 2558	<b>2442</b>	<b>2772</b>	<b>2534</b>	<b>2864</b>	<b>2609</b>	<b>2939</b>	<b>2609</b>	<b>2939</b>	<b>2855</b>	
Size range										
<b>Ordering sizes</b> Overall frame dimensions (RAM)	<b>S-panelled</b> <b>Woodgrain</b>		<b>S-panelled</b> <b>Decograin<sup>1)</sup></b>							
Width x Height	Exterior White	Exterior Color	Exterior <b>Timber design</b>							
<b>Fitting in the opening – opening outwards</b>										
From 1330 x 1960										
to 1800 x 2250	<b>2497</b>	<b>2796</b>	<b>2929</b>							
to 2200 x 2100	<b>2543</b>	<b>2842</b>	<b>2975</b>							
to 2500 x 2558	<b>2914</b>	<b>2888</b>	<b>3026</b>							

- 1) Surface in *Sandgrain* only available in the colours RAL 7016 Anthracite grey, RAL 8028 Terra brown and RAL 9006 White aluminium. Other colours or RAL to choose are not possible!
- 2) *Decograin* surface with timber design film coating or decor film coating in Titan Metallic CH 703. Please state desired decor on order!
- 3) *Decograin* surface with timber design film coating. Please state desired decor on order!

### Fastening holes £

Fastening holes for fitting in the opening Per door **17**

### RAL to choose (based on the RAL CLASSIC colour chart) or colour CH 703 £

Frame inside and outside, infill outside Surcharge on white version per door **500**

### Glazings (not possible for the two bottom door sections)

Glazing type D / section as aluminium frame See from page 340 in Price List 01-18 A

Glazing with panel glazing type S or type M See from page 342 in Price List 01-18 A

**Fittings and further optional extras** See from page 335 in Price List 01-18 A

# NT60 Aluminium Garage Side Doors





Double-leaf side doors with block frame made of aluminium profiles; door infill made of steel sectional door sections





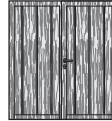

## Special sizes, ribbed/S-panelled, profile type 4

### Special sizes – profile type 4

For an overview of dimensions and optional extras, please see your dealer for more details

Size range Ordering sizes Overall frame dimensions (RAM) Width × Height										
	Exterior White	Exterior Color	Exterior White	Exterior Color	Exterior White	Exterior Color	Exterior White	Exterior Color	Exterior Timber design / Titan Metallic CH 703	
<b>Fitting in the opening – opening outwards</b>										
From 1330 × 1960										
Up to 1800 × 2250	2465	2795	2465	2795	2551	2881	2625	2955	2850	
Up to 2200 × 2100	2504	2834	2504	2834	2591	2921	2667	2997	2898	
Up to 2500 × 2558	2545	2875	2545	2875	2634	2964	2712	3042	2945	

### Special sizes – profile type 4

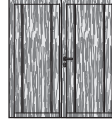
Size range Ordering sizes Overall frame dimensions (RAM) Width × Height										
	Exterior White	Exterior Color	Exterior White	Exterior Color	Exterior White	Exterior Color	Exterior White	Exterior Color	Exterior Timber design / Titan Metallic CH 703	
<b>Fitting in the opening – opening outwards</b>										
From 1330 × 1960										
Up to 1800 × 2250	2541	2871	2632	2962	2707	3037	2707	3037	2941	
Up to 2200 × 2100	2582	2912	2675	3005	2750	3080	2750	3080	2990	
Up to 2500 × 2558	2626	2956	2718	3048	2793	3123	2793	3123	3039	

### Special sizes – profile type 4

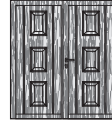
Size range Ordering sizes Overall frame dimensions (RAM) Width × Height				
	Exterior White	Exterior Color	Exterior Timber design	
<b>Fitting in the opening – opening outwards</b>				
From 1330 × 1960				
Up to 1800 × 2250	2681	2980	3113	
Up to 2200 × 2100	2727	3026	3159	
Up to 2500 × 2558	2773	3072	3210	

- 1) Surface in *Sandgrain* only available in the colours RAL 7016 Anthracite grey, RAL 8028 Terra brown and RAL 9006 White aluminium. Other colours or RAL to choose are not possible!
- 2) *Decograin* surface with timber design film coating or decor film coating in Titan Metallic CH 703. Please state desired decor on order!
- 3) *Decograin* surface with timber design film coating. Please state desired decor on order!

<b>Fastening holes</b>	£
Fastening holes for fitting in the opening	Per door 17
<b>RAL to choose</b> (based on the RAL CLASSIC colour chart) <b>or colour CH 703</b>	£
Frame inside and outside, infill outside	Surcharge on white version per door 500
<b>Fittings and further optional extras</b>	See from page 335 in Price List 01-18 A

# RollMatic Roller Garage Door

Including operator

## Size range and prices



For a product description see price list 01-18 A



Exterior  
**White or Color**

(same price)

### Prices for internal roller garage doors

Clear height (LH) = ordering size height (BMH)	3100					1826	1985	2037	2102	2155	2477	2565	2673	2728					
	3000					1826	1985	2037	2102	2155	2477	2565	2673	2728					
	2875					1826	1985	2037	2102	2155	2477	2565	2673	2728					
	2750					1801	1901	1964	2039	2117	2404	2507	2598	2689					
	<b>2675</b>	1656	1656	1718	1718	1801	1901	1964	2039	2117	2404	2507	2598	2689	2758	2818	2876	2932	
	2625	1656	1656	1718	1718	1801	1901	1964	2039	2117	2404	2507	2598	2689	2758	2818	2876	2932	
	2500	1656	1656	1718	1718	1742	1845	1908	1980	2037	2170	2412	2461	2560	2668	2726	2785	2842	
	2375	1550	1550	1579	1579	1683	1814	1860	1900	1972	2098	2322	2415	2438	2576	2634	2694	2751	
	2250	1550	1550	1579	1579	1683	1814	1860	1900	1972	2098	2322	2415	2438	2576	2634	2694	2751	
	2125	1550	1550	1579	1579	1654	1761	1790	1840	1892	1993	2061	2334	2358	2505	2563	2622	2681	
	2000	1550	1550	1579	1579	1595	1684	1743	1803	1830	1923	1985	2237	2293	2398	2454	2514	2573	
	1800	1550	1550	1579	1579	1595	1684	1743	1803	1830	1923	1985	2237	2293	2398	2454	2514	2573	
1600	1550	1550	1579	1579	1595	1684	1743	1803	1830	1923	1985	2237	2293	2398	2454	2514	2573		
		1000	1250	1500	1750	1900	2000	2250	2500	2750	3000	3250	3500	3750	4000	4250	4500	4750	5000
		Clear width (LB) = ordering size width (BMB)																	

**Only available in the priced size range listed!** (Minimum production dimension BR 1000 x 1600 mm)

**Manually operated version of the RollMatic roller garage door (not possible with external roller garage doors)** Price reduction **-218**

**External rolling shutter** Surcharge for **72**

**2-coloured RollMatic roller garage door** see page 23

**Additional fascia panel**  
(Reinforcement of the fascia panel for fitting in the opening required) see page 23

# RollMatic Roller Garage Door

Including operator

## Size range and prices

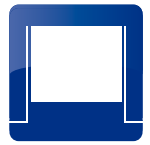

For a product description see price list 01-18 A

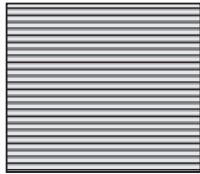

Exterior  
**Decopaint**

Golden Oak\* / Rosewood\* or  
Noir 2100 Sablé

\* Painted in timber design look on inside and outside

### Prices for internal roller garage doors

Clear height (LH) = ordering size height (BMH)	3100					1967	2143	2213	2295	2366	2706	2811	2937	3009					
	3000					1962	2139	2206	2290	2358	2698	2803	2928	3000					
	2875					1957	2133	2200	2281	2351	2689	2793	2917	2988					
	2750					1924	2043	2119	2210	2305	2607	2726	2833	2938					
	2675	1731	1748	1825	1833	1922	2039	2115	2206	2300	2601	2719	2825	2931	3016	3088	3162	3232	
	2625	1730	1746	1823	1831	1920	2035	2113	2203	2296	2597	2714	2821	2927	3011	3083	3156	3227	
	2500	1727	1742	1817	1826	1855	1973	2050	2136	2206	2355	2612	2673	2786	2909	2980	3054	3125	
	2375	1618	1631	1675	1682	1791	1936	1995	2049	2134	2273	2511	2617	2653	2805	2876	2951	3020	
	2250	1615	1627	1670	1677	1786	1929	1988	2042	2126	2265	2501	2606	2641	2793	2864	2936	3007	
	2125	1612	1622	1664	1672	1750	1870	1913	1974	2036	2151	2230	2516	2550	2709	2780	2850	2922	
2000	1608	1618	1659	1665	1686	1787	1856	1926	1966	2071	2143	2407	2474	2590	2657	2729	2799		
1800	1601	1612	1652	1657	1677	1776	1845	1915	1953	2056	2128	2390	2457	2571	2638	2707	2777		
1600																			
		1000	1250	1500	1750	1900	2000	2250	2500	2750	3000	3250	3500	3750	4000	4250	4500	4750	5000
		Clear width (LB) = ordering size width (BMB)																	

Only available in the priced size range listed!. (Minimum production dimension BR 1000 x 1600 mm).

Manually operated version of the RollMatic roller garage door (not possible with external roller garage doors) Price reduction **-218**

External roller garage door Surcharge **72**

Additional fascia panel (Reinforcement of the fascia panel for fitting in the opening required) See page 23

# RollMatic Roller Garage Door

Including operator

## Size range and prices



For a product description see price list 01-18 A

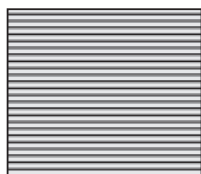

Exterior  
**Decograin\***

Golden Oak or Rosewood

\* Plastic film coating in timber design look on outside

**Note:**

External roller garage door not available with a Decograin surface!

### Prices for internal roller garage doors

Clear height (LH) = ordering size height (BMH)	3100					2371	2593	2695	2813	2915	3314	3457	3622	3726					
	3000					2358	2580	2681	2795	2898	3297	3436	3600	3704					
	2875					2346	2563	2664	2776	2876	3273	3410	3571	3674					
	2750					2303	2455	2564	2686	2813	3170	3323	3462	3602					
	2675																		
	2625	2020	2057	2163	2188	2295	2445	2552	2675	2799	3155	3307	3448	3585	3697	3803	3904	4004	
	2500	2014	2053	2159	2182	2289	2438	2545	2667	2791	3145	3298	3436	3573	3687	3792	3893	3993	
	2375	2005	2043	2147	2169	2208	2359	2465	2581	2681	2864	3167	3257	3401	3557	3657	3760	3859	
	2250	1880	1915	1981	2002	2131	2309	2396	2475	2586	2761	3042	3177	3238	3426	3523	3625	3723	
	2125	1872	1904	1969	1988	2116	2293	2377	2454	2566	2737	3016	3150	3210	3395	3491	3590	3686	
	2000	1861	1893	1955	1974	2070	2218	2281	2368	2455	2598	2703	3035	3092	3284	3381	3475	3571	
	1800	1853	1881	1942	1961	1989	2117	2209	2306	2365	2496	2594	2900	2991	3135	3227	3322	3415	
	1600	1837	1864	1922	1938	1966	2091	2181	2274	2330	2459	2552	2857	2944	3085	3174	3266	3357	
		1000	1250	1500	1750	1900	2000	2250	2500	2750	3000	3250	3500	3750	4000	4250	4500	4750	5000
		Clear width (LB) = ordering size width (BMB)																	

**Only available in the priced size range listed!** (Minimum production dimension BR 1000 x 1600 mm).

**Manually operated version of the RollMatic roller garage door (not possible with external roller garage doors)**

Price reduction **-218**

**Additional fascia panel**

(Reinforcement of the fascia panel for fitting in the opening required)

See page 23



# Optional Extras

## For RollMatic roller garage door including operator



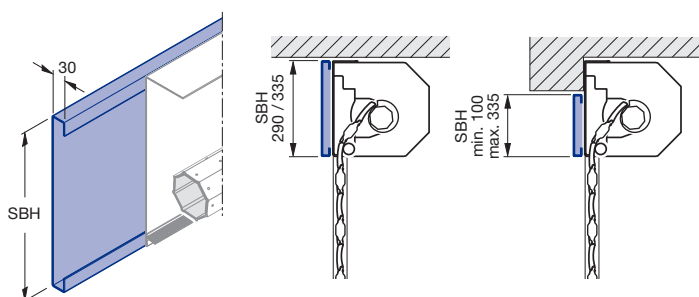

Fitting compensation set		Article no.	£
(to accommodate for unevenness on the building structure when fitting behind/in front of the opening)			
Fitting compensation set LH ≤ 2300		8991235 Per set	39
Fitting compensation set LH > 2300		8991236 Per set	45
Chamfered bottom profile			£
Roller garage door RollMatic with chamfered bottom profile (not available in the surfaces Golden Oak and Rosewood)		In black	Per m 216
		In door colour	Per m 216
Symmetrical barrel casing			£
Symmetrical barrel casing for a visually balanced look		Per door	No surcharge
Additional fascia panel			£
Reinforcement of the fascia panel			
<b>Note:</b> Required for fitting in the opening!		In door colour	Per m 53

► State additional fascia panel height (SBH) and width!



**Note:**  
State on door order, subsequent fitting is not possible.

**SBH** Fascia panel height  
**Min.** At least  
**Max.** Maximum

Optional extras		£
	<b>Glazing element</b> With clear synthetic pane, window cut-out 112 x 33 mm, black glazing frame on exterior, transparent on interior (maximum 10 sections per door, number of glazing elements depending on the door width)	Per m 25
	<b>Ventilation grille</b> Black plastic Ventilation cross section: approx. 13 cm <sup>2</sup> /grille (maximum of 10 sections per door, number of ventilation grilles depending on the door width)	Per m 25
	<b>Brush seal for fascia panel</b>	LB up to 3000 mm Per door 14 LB from 3000 mm to 5000 mm Per door 20

**Aluminium cover for side guides** (as standard with external roller garage door) Per m 43

**2-coloured roller garage door RollMatic** £

After technical clarification!

2-coloured roller garage door – frame and door curtain	Per door	105
2-coloured door curtain	Per door	294

Accessories for operator RollMatic		Article no.	£
Motor connection line, 10 m		436523	35
Acoustic anti-lift kit		436524	Each 56
Emergency battery HNA 18		437727	Each 180
Emergency release			£
Exterior emergency release for internal roller garage door		436526	Each 90
Exterior emergency release for external roller garage door	Exterior emergency release	436526	Each 90
	Accessory bag for double secured release SE	437728	Each 10
	Bowden cable, length 1 m, for double secured release SE	437986	Each 15

**Note:**  
All 3 articles are required for the external roller garage door!





**Further accessories for operator RollMatic** See the "Door operators" section from page 371 in Price List 01-18 A

# RollMatic Side Doors

## NT60 profile type 4

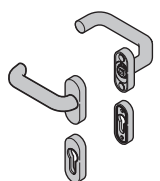
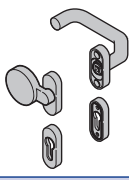
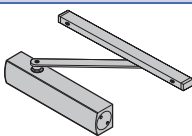
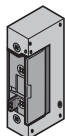
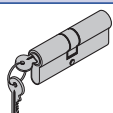

### Accessories for RollMatic side doors

Matching side door and accessories				
<b>Size Range</b> <b>Ordering sizes</b> Overall frame dimensions (RAM)  Width × Height	 <b>White or Colour</b>	 <b>Decopaint</b> <b>Golden Oak or Rosewood</b>	 <b>Decograin</b> <b>Golden Oak or Rosewood</b>	
Opening inwards or outwards				
From 875 × 1800	<b>815</b>	<b>895</b>	<b>1033</b>	
Up to 1200 × 2255				
From 1201 × 2256	<b>853</b>	<b>927</b>	<b>1080</b>	
Up to 1284 × 2500				
Note: View of internal roller garage door / external roller garage door, state opening sense and handing!				
Optional extras			Article no.	£
	<b>Glazing element</b> With clear synthetic pane, window cut-out 112 × 33 mm, black glazing frame on exterior, transparent on interior (maximum 10 sections per door, number of glazing elements depending)		Per m	<b>25</b>
	<b>Ventilation grille</b> Black plastic Ventilation cross section: approx. 13 cm <sup>2</sup> /grille (maximum of 10 sections per door, number of ventilation grilles depending on the door width)		Per m	<b>25</b>
Lever Handle Sets				
	Cast aluminium with natural finish (F1), prepared for profile cylinder		Each	<b>106</b>
	Cast aluminium with silver finish (F2), prepared for profile cylinder		Each	<b>106</b>
	Cast aluminium in RAL 9016, prepared for profile cylinder		Each	<b>127</b>
	Cast aluminium in brown, prepared for profile cylinder		Each	<b>127</b>
	Brushed stainless steel, prepared for profile cylinder		Each	<b>139</b>
Lever / knob handle sets				
	Black plastic, prepared for profile cylinder		Each	<b>59</b>
	Cast aluminium with natural finish (F1), prepared for profile cylinder		Each	<b>122</b>
	Cast aluminium with silver finish (F2), prepared for profile cylinder		Each	<b>122</b>
	Cast aluminium in RAL 9016, prepared for profile cylinder		Each	<b>153</b>
	Cast aluminium in brown, prepared for profile cylinder		Each	<b>153</b>
	Brushed stainless steel, prepared for profile cylinder		Each	<b>162</b>
Overhead door closer				
	Overhead door closer with slide rail and hold-open device		Each	<b>244</b>
3-point locking				
	3-point locking with latch, bolt, and 2 locking hooks; keys to differ cannot be retrofitted!		Per door	<b>374</b>
Electric door strike with day and night setting (without wiring). For doors with block frame made of aluminium profiles.				
	10–24 V, LH hinged / RH hinged (only opens with an impulse, i.e. as long as the button is pressed)		Each	<b>92</b>
	10–24 V, LH hinged / RH hinged (remains open after impulse until the door is actuated, subsequent locking by door strike)		Each	<b>123</b>
Block reed contact				
	Block reed contact (article no. 4004810)		Each	<b>90</b>
Panic locks				
	<b>Panic lock function E</b> For profile cylinders, for fixed knob on outside; the door can only be opened from the outside using a key.		Each	<b>184</b>
Profile double cylinder				
	Profile double cylinder <b>40 + 40 mm</b> Keys to pass, for side doors profile type 4			<b>on request</b>

For additional optional extras please refer to the 01-18 A price list

# Roller Garage Door – RollMatic TDL

Including tubular drive

## Size range and prices

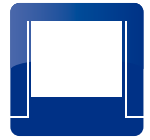

### Prices for internal roller garage doors

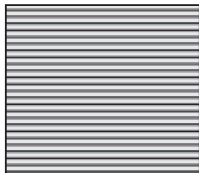

Exterior  
RAL 9016 Traffic white or  
RAL 7016 Anthracite grey

2300	1242	1242	1270	1270	1371	1498	1542	1581	1650
2125	1242	1242	1270	1270	1328	1433	1495	1528	1584
2000	1242	1242	1270	1270	1286	1372	1429	1487	1513
1750	1242	1242	1270	1270	1286	1372	1429	1487	1513
1500	1242	1242	1270	1270	1286	1372	1429	1487	1513
	1250	1500	1750	1900	2000	2250	2500	2750	3050

Clear width (LB) = ordering size

Only available in the priced size range listed! (Minimum production dimension BR 1250 x 1500 mm)

### Prices for internal roller garage doors



Exterior  
Decopaint Golden Oak\* or  
Noir 2100 Sablé (Anthracite metallic)

2300	1304	1315	1356	1365	1470	1609	1666	1717	1801
2125	1304	1315	1356	1365	1427	1544	1619	1664	1735
2000	1295	1307	1346	1352	1372	1470	1537	1606	1644
1750	1289	1299	1336	1342	1362	1457	1522	1590	1627
1500	1282	1290	1327	1332	1351	1444	1509	1577	1610
	1250	1500	1750	1900	2000	2250	2500	2750	3050

Clear width (LB) = ordering size

\* Painted in timber design look on inside and outside

Only available in the priced size range listed! (Minimum production dimension BR 1250 x 1500 mm)

Accessory	Description	Part no.		£
	<b>RollMatic TDL hand transmitter</b> Impulse, Incl. battery 433.92 MHz Battery: 3 V / type: 2025 Dimensions (W x H x D): 28 x 58 x 25mm	RSC2	Each	48

### Important product information

Please note that the RollMatic TDL cannot be fitted to a garage without alternate access.

# Overhead Garage Door RollMatic OD

Including side operator ProMatic

## Size range and prices



For a product description, see price list 01-18 A

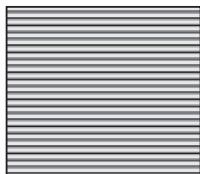

Exterior  
**White or Color**

(same price)

### Prices for overhead doors RollMatic OD

Clear height (LH) = ordering size height (BMH)	3000	1694	1720	1749	1780	1822	1872	1913	1960	2001	2050	
	2875	1659	1688	1716	1746	1786	1824	1872	1917	1959	1998	
	2750	1520	1654	1689	1715	1748	1787	1833	1876	1914	1952	
	2625	1479	1518	1650	1677	1715	1747	1791	1834	1871	1906	
	2500	1447	1482	1479	1663	1697	1735	1778	1822	1857	1895	
	2375	1412	1445	1464	1568	1600	1640	1676	1713	1743	1780	
	2250	1383	1410	1444	1482	1512	1547	1584	1615	1648	1683	
	2125	1348	1384	1412	1445	1476	1508	1543	1574	1601	1638	
	2000	1316	1356	1382	1409	1439	1469	1501	1532	1561	1593	
	1875	1291	1326	1366	1378	1411	1444	1472	1505	1537	1568	
	1700											
		1000	1250	1500	1750	2000	2250	2500	2750	3000	3250	3500
		Clear width (LB) = ordering size width (BMB)										

Only available in the priced size range listed! (min. production dimension BR 1000 x 1700 mm)

### SupraMatic E

£



**Optional with garage door operator SupraMatic E**  
With 5-button hand transmitter HS 5 BS (black textured surface)

Surcharge for **138**

2-coloured overhead door RollMatic OD

see page 29

Optional extras for overhead garage door RollMatic OD

see page 29

# Overhead Garage Door RollMatic OD

Including side operator ProMatic

## Size range and prices



For a product description, see price list 01-18 A

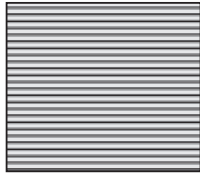

Exterior  
**Decopaint \***

Golden Oak / Rosewood  
or Noir 2100 Sablé

\* Painted in timber design look on inside and outside

### Prices for overhead doors RollMatic OD

Clear height (LH) = ordering size height (BMH)	3000	1779	1823	1872	1916	1976	2042	2101	2163	2222	2288	
	2875	1740	1787	1832	1877	1934	1987	2051	2113	2171	2226	
	2750	1597	1748	1800	1838	1890	1942	2005	2064	2116	2171	
	2625	1553	1608	1754	1796	1849	1896	1956	2013	2064	2113	
	2500	1519	1568	1578	1776	1825	1877	1934	1991	2043	2095	
	2375	1480	1526	1559	1676	1722	1774	1825	1875	1918	1969	
	2250	1448	1487	1534	1585	1627	1675	1725	1769	1814	1862	
	2125	1410	1457	1497	1542	1585	1631	1676	1719	1759	1808	
	2000	1374	1424	1462	1500	1542	1582	1624	1668	1708	1751	
	1875	1342	1388	1438	1460	1503	1546	1585	1628	1671	1710	
1700												
		1000	1250	1500	1750	2000	2250	2500	2750	3000	3250	3500
		Clear width (LB) = ordering size width (BMB)										

Only available in the priced size range listed! (min. production dimension BR 1000 x 1700 mm)

### SupraMatic E

£



**Optional with garage door operator SupraMatic E**  
With 5-button hand transmitter HS 5 BS (black textured surface)

Surcharge for

**138**

Optional extras for overhead garage door RollMatic OD

see page 29

# Overhead Garage Door RollMatic OD

Including side operator ProMatic

## Size range and prices



For a product description, see price list 01-18 A

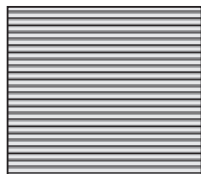

Exterior  
**Decograin \***

Golden Oak or Rosewood

\* Plastic film coating in timber design look on outside

### Prices for overhead doors RollMatic OD

Clear height (LH) = ordering size height (BMH)	3000	2079	2149	2224	2312	2416	2517	2606	2703	2821	2921
	2875	2035	2107	2180	2266	2364	2452	2546	2638	2755	2843
	2750	1888	2062	2141	2217	2302	2387	2481	2572	2679	2767
	2625	1837	1915	2091	2165	2251	2328	2419	2508	2611	2697
	2500	1796	1869	1908	2130	2212	2292	2378	2466	2551	2650
	2375	1742	1810	1866	2016	2095	2176	2250	2327	2406	2500
	2250	1705	1764	1834	1915	1991	2064	2137	2209	2286	2377
	2125	1659	1727	1788	1861	1933	1999	2070	2137	2206	2281
	2000	1619	1687	1745	1803	1872	1936	2004	2067	2133	2202
	1875	1578	1640	1708	1749	1817	1882	1943	2005	2073	2135
1700											
	1000	1250	1500	1750	2000	2250	2500	2750	3000	3250	3500
	Clear width (LB) = ordering size width (BMB)										

Only available in the priced size range listed! (min. production dimension BR 1000 x 1700 mm)

### SupraMatic E

£



Optional with garage door operator **SupraMatic E**  
With 5-button hand transmitter HS 5 BS (black textured surface)

Surcharge for

**138**



Optional extras for overhead garage door RollMatic OD

see page 29

# Optional Extras

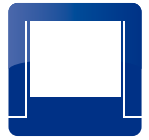
For overhead garage door RollMatic OD including side operator ProMatic

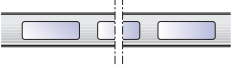

Optional extras	Article no.	£
 <p><b>Glazing element</b> With clear synthetic pane, window cut-out 112 x 33 mm, black glazing frame on exterior, transparent on interior (maximum 10 sections per door, number of glazing elements depending on the door width)</p>	Per m	<b>25</b>
 <p><b>Ventilation grille</b> Black plastic Ventilation cross section: approx. 13 cm<sup>2</sup>/grille (maximum of 10 sections per door, number of ventilation grilles depending on the door width)</p>	Per m	<b>25</b>

2-coloured overhead door RollMatic OD	£
After technical clarification!	
2-coloured roller garage door – frame and door curtain	Per door <b>105</b>
2-coloured door curtain	Per door <b>294</b>

## //NEW Retrofit fascia panels for flush fitting

### Set: fascia frame OD

- As cover for lintel and frame with flush-fitting installation and for renovations
- For use with doors up to LB max. 3150 mm and LH max. 2700 mm

### Consisting of:

- 2 fascias, width 95 mm, length 2800 mm each,
- 1 fascia, width 95 mm, length 3200 mm,
- including additional fixing material for panel and door
- 2 plastic panel shoes (black)

### Note:

The vertical tracks and the fascia panel are pre-drilled at the factory if this fitting is selected.

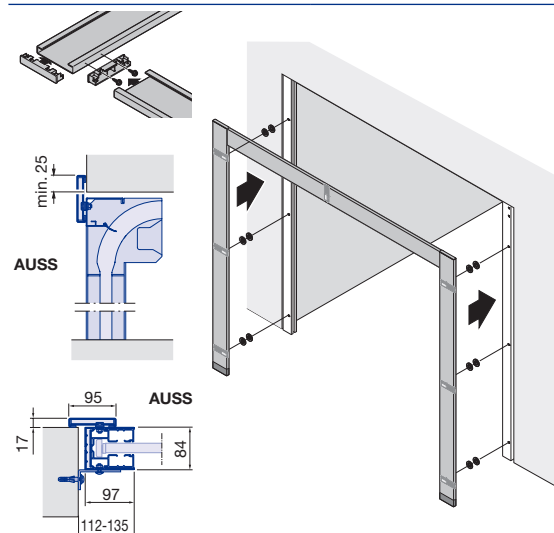

### Surface finish

White, based on RAL 9016 or Color

Per set

**236**

**Emergency release NET 4**  
(required if there is no second entrance)

See the "Door operators" section in the 01-18 A

**Accessories for operator ProMatic /SupraMatic E**

See the "Door operators" section in the 01-18 A

# Garage Door Operators

## Operator Accessories







### Garage door operators

Boom Length	SupraMatic E	SupraMatic P	SupraMatic HT	ProMatic	ProMatic Akku
K	530	602	For prices and specification see the 01-18 A Price List	422	740
M	555	627		447	765
L	653	725		545	863

Hand transmitters with BiSecur technology are backwards compatible, i.e. they can also be used with series 1 and 2 operators (868 MHz). Hand transmitter 868 MHz BiSecur, incl. battery (Range of radio signal depends on local conditions)

- Possible
- Only in combination with a BiSecur radio receiver
- Only in conjunction with the BiSecur radio receiver ESE, status query possible
- Not possible

Accessory	Description	Garage door operators				
		SupraMatic E / P	SupraMatic HT	ProMatic	ProMatic Akku	RollMatic
<b>HS</b> 1-button hand transmitter  Black <b>HS 1 BS</b> Art. no. 4511720 £ 63	<b>Textured plastic surface with chrome-plated zinc die-cast caps</b> <ul style="list-style-type: none"> <li>• Impulse</li> <li>• Protection category: for dry rooms only</li> <li>• Temperature range: -20 °C to +60 °C</li> <li>• Battery: 1.5 V LR03 / AAA</li> <li>• Dimensions: 38 × 95 × 16 mm</li> </ul>	●	●	●	●	●
<b>HS</b> 4-button hand transmitter  Black <b>HS 4 BS</b> Art. no. 4511724 £ 63	<b>Textured plastic surface with chrome-plated zinc die-cast caps</b> <ul style="list-style-type: none"> <li>• Impulse</li> <li>• Protection category: for dry rooms only</li> <li>• Temperature range: -20 °C to +60 °C</li> <li>• Battery: 1.5 V LR03 / AAA</li> <li>• Dimensions: 38 × 95 × 16 mm</li> </ul>	●	●	●	●	●
<b>HS</b> 5-button hand transmitter  Black <b>HS 5 BS</b> Art. no. 436946 £ 74	<b>Textured plastic surface with chrome-plated zinc die-cast caps</b> <ul style="list-style-type: none"> <li>• Impulse</li> <li>• Status query</li> <li>• Protection category: for dry rooms only</li> <li>• Temperature range: -20 °C to +60 °C</li> <li>• Battery: 1.5 V LR03 / AAA</li> <li>• Dimensions: 38 × 95 × 16 mm</li> </ul>	●	●	●	-	-
<b>HS</b> 5-button hand transmitter  Black                      White <b>HS 5 BS                      HS 5 BS</b> Art. no. 436752                      436753 £ 74                                      74	<b>High gloss plastic surface with chrome-plated zinc die-cast caps</b> <ul style="list-style-type: none"> <li>• Impulse</li> <li>• Status query</li> <li>• Protection category: for dry rooms only</li> <li>• Temperature range: -20 °C to +60 °C</li> <li>• Battery: 1.5 V LR03 / AAA</li> <li>• Dimensions: 38 × 95 × 16 mm</li> </ul>	●	●	●	-	-



# Garage Door Operators

## Operator Accessories



Hand transmitters with BiSecur technology are backwards compatible, i.e. they can also be used with series 1 and 2 operators (868 MHz). Hand transmitter 868 MHz BiSecur, incl. battery (Range of radio signal depends on local conditions)

- Possible
- Only in combination with a BiSecur radio receiver
- Only in conjunction with the BiSecur radio receiver ESE, status query possible
- Not possible

Accessory		Description	Garage door operators				
			SupraMatic E/P	SupraMatic HT	ProMatic	ProMatic Akku	RollMatic
<b>Accessories</b> For hand transmitters (HS and HSS)		<ul style="list-style-type: none"> <li>For HS 1 BS, HS 4 BS, HS 5 BS, HSS 4 BS</li> </ul>					
<b>Hand transmitter station</b> Art. no. 436691 437077 436692 £ 11 11 11							
For hand transmitters (HS and HSS)		<ul style="list-style-type: none"> <li>For HS 1 BS, HS 4 BS, HS 5 BS, HSS 4 BS</li> <li>For wall fitting or for fitting to the visor clip</li> <li>Without fitting material</li> </ul>					
<b>Hand transmitter holder</b> Transparent, incl. visor clip Art. no. 436698 £ 10							
<b>HSE</b> 1-button hand transmitter		<b>Textured plastic surface with chrome-plated zinc die-cast caps</b> <ul style="list-style-type: none"> <li>Impulse</li> <li>Incl. key ring for fastening to the key chain</li> <li>Protection category: for dry rooms only</li> <li>Temperature range: 0 °C to +60 °C</li> <li>Battery: Lithium round cell 3 V / type CR 2032</li> <li>Dimensions: 28 × 70 × 14 mm</li> </ul>	●	●	●	●	●
<b>HSE 1 BS</b> Art. no. 4511728 £ 63							
<b>HSE</b> 2-button hand transmitter		<b>High gloss plastic surface with chrome-plated zinc diecast caps</b> <ul style="list-style-type: none"> <li>Impulse</li> <li>Incl. key ring for fastening to the key chain</li> <li>Protection category: for dry rooms only</li> <li>Temperature range: 0 °C to +60 °C</li> <li>Battery: Lithium round cell 3 V / type CR 2032</li> <li>Dimensions: 28 × 70 × 14 mm</li> </ul>					
<b>HSE 2 BS</b> <b>HSE 2 BS</b> Art. no. 436754      436755 £ 63      63							
<b>HSE</b> 2-button hand transmitter HSE 2 BS			●	●	●	●	●
Housing colour	Art. no.	£					
Purple	436869	74					
Orange	436870	74					
Yellow	436871	74					
Red	436872	74					
Green	436873	74					
Carbon	436863	74					
Silver	436864	74					
Dark rootwood look	436866	74					

# Garage Door Operators

## Operator Accessories









Hand transmitters with BiSecur technology are backwards compatible, i.e. they can also be used with series 1 and 2 operators (868 MHz). Hand transmitter 868 MHz BiSecur, incl. battery (Range of radio signal depends on local conditions)

- Possible
- Only in combination with a BiSecur radio receiver
- Only in conjunction with the BiSecur radio receiver ESE, status query possible
- Not possible

### Garage door operators

SupraMatic E / P	SupraMatic HT	ProMatic	ProMatic Akku	RollMatic
------------------	---------------	----------	---------------	-----------

Accessory	Description	SupraMatic E / P	SupraMatic HT	ProMatic	ProMatic Akku	RollMatic
<p><b>HSE</b> 4-button hand transmitter</p>  <p>Black</p> <p><b>HSE 4 BS</b></p> <p>Art. no. 4511732</p> <p>£ <b>63</b></p>	<p><b>Textured plastic surface with chrome-plated zinc die-cast caps</b></p> <ul style="list-style-type: none"> <li>• Impulse</li> <li>• Incl. key ring for fastening to the key chain</li> <li>• Protection category: for dry rooms only</li> <li>• Temperature range: 0 °C to +60 °C</li> <li>• Battery: Lithium round cell 3 V / type CR 2032</li> <li>• Dimensions: 28 × 70 × 14 mm</li> </ul>	●	●	●	●	●
<p><b>HSE</b> 4-button hand transmitter</p>  <p>Black</p> <p><b>HSE 4 BS</b></p> <p>Art. no. 4511736</p> <p>£ <b>57</b></p>	<p><b>Textured plastic surface with plastic caps</b></p> <ul style="list-style-type: none"> <li>• Impulse</li> <li>• Incl. key ring for fastening to the key chain</li> <li>• Protection category: for dry rooms only</li> <li>• Temperature range: 0 °C to +60 °C</li> <li>• Battery: Lithium round cell 3 V / type CR 2032</li> <li>• Dimensions: 28 × 70 × 14 mm</li> </ul>	●	●	●	●	●
<p><b>HSP</b> 4-button hand transmitter</p>  <p>Black</p> <p><b>HSP 4 BS</b></p> <p>Art. no. 436776</p> <p>£ <b>66</b></p>	<ul style="list-style-type: none"> <li>• Impulse</li> <li>• With sliding switch as a button lock-out</li> <li>• Incl. key ring</li> <li>• Protection category: for dry rooms only</li> <li>• Temperature range: -20 °C to +60 °C</li> <li>• Battery: Lithium round cell 3 V / type CR 2025</li> <li>• Dimensions (D × H): Ø 48 × 13 mm</li> </ul>	●	●	●	●	●
<p><b>HSD</b> 2-button hand transmitter</p>  <p>Aluminium</p> <p><b>HSD 2-A BS</b></p> <p>Art. no. 436774</p> <p>£ <b>89</b></p>  <p>Chrome</p> <p><b>HSD 2-C BS</b></p> <p>Art. no. 436775</p> <p>£ <b>89</b></p>	<ul style="list-style-type: none"> <li>• Impulse</li> <li>• High-quality metal housing</li> <li>• As a key ring</li> <li>• Protection category: for dry rooms only</li> <li>• Temperature range: 0 °C to +60 °C</li> <li>• Battery: Lithium round cell 3 V / type CR 2025</li> <li>• Dimensions (W × H × D): 32 × 66 × 13 mm</li> </ul>	●	●	●	●	●
<p><b>HSZ</b> 1-button hand transmitter</p>  <p>Black</p> <p><b>HSZ 1 BS</b></p> <p>Art. no. 436779</p> <p>£ <b>57</b></p> <p><b>HSZ</b> 2-button hand transmitter</p>  <p>Black</p> <p><b>HSZ 2 BS</b></p> <p>Art. no. 436782</p> <p>£ <b>57</b></p>	<ul style="list-style-type: none"> <li>• Impulse</li> <li>• For insertion in a vehicle cigarette lighter</li> <li>• Protection category: for dry rooms only</li> <li>• Temperature range: -20 °C to +60 °C</li> <li>• Battery: Lithium 3 V / type CR 2</li> <li>• Dimensions (D × H): Ø 29 × 39 mm</li> </ul>	●	●	●	●	●

# Garage Door Operators

## Operator Accessories







Hand transmitters with BiSecur technology are backwards compatible, i.e. they can also be used with series 1 and 2 operators (868 MHz). Hand transmitter 868 MHz BiSecur, incl. battery (Range of radio signal depends on local conditions)

- Possible
- Only in combination with a BiSecur radio receiver
- Only in conjunction with the BiSecur radio receiver ESE, status query possible
- Not possible

### Garage door operators

SupraMatic E/P	SupraMatic HT	ProMatic	ProMatic Akku	RollMatic
----------------	---------------	----------	---------------	-----------

#### Radio internal push button / internal receiver

<p><b>FIT</b> 1-button radio internal push button</p>  <p>Art. no. <b>FIT 1 BS</b> 439740</p> <p>£ <b>93</b></p>	<ul style="list-style-type: none"> <li>• Impulse</li> <li>• Protection category: for dry rooms only</li> <li>• Temperature range: -20°C to +60°C</li> <li>• Battery: 2 x 1.5 V LR03/AAA</li> <li>• Colour: Pure white RAL 9010</li> <li>• Dimensions (W x H x D): 80 x 80 x 15 mm</li> </ul>	<table border="1"> <tr> <td>●</td> <td>●</td> <td>●</td> <td>●</td> <td>●</td> </tr> </table>	●	●	●	●	●
●	●	●	●	●			
<p><b>FIT</b> 4-button radio internal push button</p>  <p>Art. no. <b>FIT 4 BS</b> 439741</p> <p>£ <b>93</b></p>	<ul style="list-style-type: none"> <li>• Impulse</li> <li>• Protection category: for dry rooms only</li> <li>• Temperature range: -20°C to +60°C</li> <li>• Battery: 2 x 1.5 V LR03/AAA</li> <li>• Colour: Pure white RAL 9010</li> <li>• Dimensions (W x H x D): 80 x 80 x 15 mm</li> </ul>	<table border="1"> <tr> <td>●</td> <td>●</td> <td>●</td> <td>●</td> <td>●</td> </tr> </table>	●	●	●	●	●
●	●	●	●	●			
<p><b>FIT</b> 5-button radio internal push button</p>  <p>Art. no. <b>FIT 5 BS</b> 439742</p> <p>£ <b>108</b></p>	<ul style="list-style-type: none"> <li>• Impulse</li> <li>• Status query</li> <li>• Protection category: for dry rooms only</li> <li>• Temperature range: -20°C to +60°C</li> <li>• Battery: 2 x 1.5 V LR03/AAA</li> <li>• Colour: Pure white RAL 9010</li> <li>• Dimensions (W x H x D): 80 x 80 x 15 mm</li> </ul>	<table border="1"> <tr> <td>●</td> <td>●</td> <td>●</td> <td>-</td> <td>-</td> </tr> </table>	●	●	●	-	-
●	●	●	-	-			
<p><b>FES</b> Radio receiver electric socket</p>  <p>Art. no. <b>FES 1 BS</b> 439762</p> <p>£ <b>100</b></p>	<ul style="list-style-type: none"> <li>• To switch the light and further consumers on/off</li> <li>• Functions: impulse, on and off, status feedback</li> <li>• Protection category: IP 20</li> <li>• Stand by: &lt; 0.5 W</li> <li>• Temperature range: -20 °C to +35 °C</li> <li>• Operating voltage: 100-240 V AC</li> <li>• Electric socket switching capacity: <ul style="list-style-type: none"> <li>- 2500 W / 10 A resistivity</li> <li>- 500 W inductive load</li> </ul> </li> <li>• Colour: Pure white RAL 9010</li> <li>• Dimensions (W x H x D): 80 x 80 x 67 mm</li> </ul>	<table border="1"> <tr> <td></td> <td></td> <td></td> <td></td> <td></td> </tr> </table>					
<p><b>FES</b> Radio receiver electric socket</p>  <p>Art. no. <b>FES 1-1 BS</b> 439763</p> <p>£ <b>113</b></p>	<ul style="list-style-type: none"> <li>• For Hörmann door operators and operators of other makes to switch lights and other consumers on and off</li> <li>• Functions: <ul style="list-style-type: none"> <li>- Impulse, on and off, status feedback</li> <li>- Impulse for door operator, without operator status feedback</li> </ul> </li> <li>• Protection category: IP 20</li> <li>• Stand by: &lt; 0.5 W</li> <li>• Temperature range: -20 °C to +35 °C</li> <li>• Operating voltage: 100-240 V AC</li> <li>• Electric socket switching capacity: <ul style="list-style-type: none"> <li>- 2500 W / 10 A resistivity</li> <li>- 500 W inductive load</li> </ul> </li> <li>• Impulse output switching capacity: 24 V / max. 110 mA</li> <li>• With connecting lead 1 x 2 m, 2-wire</li> <li>• Colour: Pure white RAL 9010</li> <li>• Dimensions (W x H x D): 80 x 80 x 67 mm</li> </ul>	<table border="1"> <tr> <td></td> <td></td> <td></td> <td></td> <td></td> </tr> </table>					

# Garage Door Operators

## Operator Accessories







Hand transmitters with BiSecur technology are backwards compatible, i.e. they can also be used with series 1 and 2 operators (868 MHz). Hand transmitter 868 MHz BiSecur, incl. battery (Range of radio signal depends on local conditions)

- Possible
- Only in combination with a BiSecur radio receiver
- Only in conjunction with the BiSecur radio receiver ESE, status query possible
- Not possible

### Garage door operators

SupraMatic E/P	SupraMatic HT	ProMatic	ProMatic Akku	RollMatic
----------------	---------------	----------	---------------	-----------

**Radio internal push button 868 MHz BiSecur, incl. battery**  
(Range of radio signal depends on local conditions)

<p><b>FCT 3 BS</b> Radio code switch</p>  <p><b>FCT 3 BS</b> 436758 £ 104</p>	<ul style="list-style-type: none"> <li>• Impulse, for control of up to 3 door operators</li> <li>• Transmission of up to 3 radio codes, 868 MHz</li> <li>• Power supply: Battery 4 × 1.5 V LR03 / AAA</li> <li>• <b>Illuminated keypad</b>, clip frame</li> <li>• Protection category: IP 54</li> <li>• Temperature range: -20°C to +60°C</li> <li>• Housing: Plastic</li> <li>• Dimensions (W × H × D): 80 × 135 × 40 mm</li> </ul>	<table border="1"> <tr><td>●</td><td>●</td><td>●</td><td>●</td><td>●</td></tr> </table>	●	●	●	●	●
●	●	●	●	●			
<p><b>FCT 10 BS</b> Radio code switch</p>  <p><b>FCT 10 BS</b> 436759 £ 159</p>	<ul style="list-style-type: none"> <li>• Impulse, for control of up to 10 door operators</li> <li>• Transmission of up to 10 radio codes, 868 MHz</li> <li>• Power supply: Battery 4 × 1.5 V LR03 / AAA</li> <li>• <b>Illuminated keypad</b>, sliding cover with metal embellishment</li> <li>• Protection category: IP 54</li> <li>• Temperature range: -20°C to +60°C</li> <li>• Housing: Plastic</li> <li>• Dimensions (W × H × D): 80 × 135 × 40 mm</li> </ul>	<table border="1"> <tr><td>●</td><td>●</td><td>●</td><td>●</td><td>●</td></tr> </table>	●	●	●	●	●
●	●	●	●	●			
<p><b>CTR</b> Code switch</p>  <p><b>CTR 1b-1</b> 4511631 £ 203 <b>CTR 3b-1</b> 4511632 £ 234</p>	<ul style="list-style-type: none"> <li>• Impulse</li> <li>• Illuminated keyboard</li> <li>• With 5 m connecting cable between the input unit and the decoder</li> <li>• Operating voltage: optionally 100–240 V AC or 10–24 V AC / DC</li> <li>• Max. switching capacity: <ul style="list-style-type: none"> <li>– 30 V DC / 2.5 A (resistive load)</li> <li>– 230 V AC / 500 W (resistive load)</li> </ul> </li> <li>• Protection category: <ul style="list-style-type: none"> <li>– Input unit IP 65</li> <li>– Decoder unit IP20</li> </ul> </li> <li>• Temperature range: -20°C to +60°C</li> <li>• Input unit dimensions (W × H × D): 80 × 80 × 15 mm Decoder unit dimensions (W × H × D): 140 × 130 × 50 mm</li> <li>• Without connecting lead, connection cables for power supply <ul style="list-style-type: none"> <li>– 230 V AC: Use connection cable ZL 1</li> <li>– 24 V AC / DC and for providing impulse to operator: Use ASL connection cables</li> </ul> </li> </ul>	<table border="1"> <tr><td>●</td><td>●</td><td>●</td><td>-</td><td>●</td></tr> </table>	●	●	●	-	●
●	●	●	-	●			
<p><b>CTP</b> Code switch</p>  <p><b>CTP 3-1</b> 4511634 £ 278</p>	<ul style="list-style-type: none"> <li>• Illuminated capacitive keyboard</li> <li>• Impulse</li> <li>• With 5 m connecting cable between the input unit and the decoder</li> <li>• Operating voltage: optionally 100–240 V AC or 10–24 V AC / DC</li> <li>• Max. switching capacity: <ul style="list-style-type: none"> <li>– 30 V DC / 2.5 A (resistive load)</li> <li>– 230 V AC / 500 W (resistive load)</li> </ul> </li> <li>• 3 separate relay outputs for control of 2 operators, second opening height, outdoor lighting</li> <li>• Protection category: <ul style="list-style-type: none"> <li>– Input unit IP 65</li> <li>– Decoder unit IP20</li> </ul> </li> <li>• Temperature range: -20°C to +60°C</li> <li>• Input unit dimensions (W × H × D): 80 × 80 × 15 mm Decoder unit dimensions (W × H × D): 140 × 130 × 50 mm</li> <li>• Without mains lead, connection cables for power supply <ul style="list-style-type: none"> <li>– 230 V AC: Use connection cable ZL 1</li> <li>– 24 V AC / DC and for providing impulse to operator: Use ASL connection cables</li> </ul> </li> </ul>	<table border="1"> <tr><td>●</td><td>●</td><td>●</td><td>-</td><td>●</td></tr> </table>	●	●	●	-	●
●	●	●	-	●			

# Garage Door Operators

## Operator Accessories



Hand transmitters with BiSecur technology are backwards compatible, i.e. they can also be used with series 1 and 2 operators (868 MHz). Hand transmitter 868 MHz BiSecur, incl. battery (Range of radio signal depends on local conditions)

- Possible
- Only in combination with a BiSecur radio receiver
- Only in conjunction with the BiSecur radio receiver ESE, status query possible
- Not possible

Garage door operators				
SupraMatic E/P	SupraMatic HT	ProMatic	ProMatic Akku	RollMatic

### Radio internal push button 868 MHz BiSecur, incl. battery (Range of radio signal depends on local conditions)

**FIT** Radio internal push button

// NEW



- Impulse
- With 2 impulse push buttons for control of 2 operators via radio signal
- One additional button for On/Off function of connected external control elements
- Connection option for max. 2 control elements (volt-free contact) e.g. key switch
- Protection category: for dry rooms only
- Temperature range: -20°C to +60°C
- Battery: 2 x 1.5 V LR03/AAA
- Colour: Pure white RAL 9010
- Dimensions (W x H x D): 80 x 80 x 45 mm

**FIT 2-1 BS**

Art. no. 4511652  
£ 74

**IT 3b-1** Internal push button

// NEW



- Impulse
- Additional buttons for light on/off and operator on/off (vacation mode)
- Illuminated keyboard
- With 7 m connection cable, 2-wire
- Protection category: for dry rooms only
- Temperature range: -20°C to +60°C
- Colour: Pure white RAL 9010
- Dimensions (W x H x D): 80 x 80 x 45 mm

**IT 3b-1**

Art. no. 4511647  
£ 42

### Radio finger-scan 868 MHz BiSecur (range of radio signal depends on local conditions!)

**FFL** Radio finger-scan



- Impulse, to control 2 operators using a fingerprint
- Up to 12 fingerprints can be taught in, cannot be individually deleted
- Setting/programming via 3 buttons
- Housing: Plastic, sliding cover with metal embellishment
- Display via 3 LEDs
- Battery: 4 x 1.5 V LR03 / AAA
- Protection category: IP 54
- Temperature range: -20°C to +60°C
- Dimensions (W x H x D): 80 x 130 x 45 mm

Only for use with Hörmann BiSecur 868 MHz receivers.

**FFL 12 BS**

Art. no. 436788  
£ 225

### Batteries

### Description

**HNA** Emergency battery



- Emergency power supply to bypass power failures up to 18 hours and max. 5 door cycles (depending on temperatures, situation of charge etc.)
- To be fixed on operator or garage ceiling
- Protection category: for dry rooms only
- Weight: approx. 2.3 kg
- Operating voltage: 24 V DC / 2.3 Ah
- Dimensions (W x H x D): 150 x 70 x 90 mm

Also suitable for series 2 SupraMatic and ProMatic operators.

**HNA 18-3**

Art. no. 437726  
£ 206

**HNA** Emergency battery



- Emergency power supply to bridge power outages
- Universal fixing for wall and floor fitting
- Double LED function display
- Protection category: IP 65
- Weight: approx. 3 kg
- Dimensions: 213 x 143 x 96 mm
- Battery voltage: 24 V DC / 2.3 Ah

For RotaMatic/P/PL from autumn 2010 and for LineaMatic/P/H from year of manufacture 10/2009.

**HNA Outdoor**

Art. no. 436522  
£ 219

# Warranty

Hörmann products are manufactured to the highest quality standards and leave our factory only after rigorous quality testing. However, if you should have grounds for complaint, this section tells you what our door warranty offers, and how to go about making your claim.

In the unlikely event of a warranty claim becoming necessary, please contact the dealer or distributor who originally supplied your garage door. Your dealer should then supply details of the claim, together with a copy of the warranty card provided with the door and proof of purchase to the Product Services Department at Hörmann (UK) Ltd. To enable your claim under warranty to be processed as quickly as possible, you should provide the following details:

1. Your name, address and telephone number
2. Original invoice with date of purchase
3. Product description/door type and product number
4. Description of defect

An assessment of the claim will then be made. This may require Hörmann to inspect the product in-situ. In the event that there is no legitimate warranty claim under the terms specified herein, you may be liable for the costs of the inspection visit. We strongly recommend that you take note of the care and usage instructions displayed on the stickers on the back of your garage door, and on the page opposite, and that you follow these instructions throughout.

## Hörmann installers

Hörmann (UK) Ltd has a nationwide network of recommended installers who will be able to offer you a regular maintenance service on your garage door. Please call us on 01530 513050 for details of your nearest dealer.

## Hörmann (UK) Ltd Garage Door Warranty

<b>Warranty Period</b>	The purchaser is granted a warranty covering the safe and reliable function of the Hörmann garage door for a period of 10 years from the date of purchase. A 5 year warranty applies to springs, wire cables, track rollers, hinges and guide rollers. The warranty period for replacement parts is 6 months or to the end of the current warranty period, whichever is longer. In the case of foil-coated timber-effect, a warranty of 5 years is granted, for timber and GRP doors a warranty of 2 years is granted on the door panels alone under the terms and conditions specified herein. The door mechanism and steel frame (if applicable) is covered by the 10 year warranty period.
<b>Requirements</b>	Warranty claims are only applicable in the country where the garage door was purchased. The product must have been purchased through our authorised distribution channels. The warranty only covers damage to the contract object. The fully completed warranty card together with the receipt of purchase correspondingly dated substantiates your right to claim under the warranty.
<b>Performance</b>	During the warranty period we undertake to rectify any and all defects to the Hörmann product which can be proved to be attributed to a material or manufacturing fault. We pledge at our discretion either to exchange the defective merchandise for faultless merchandise, repair it or allow a reduction in price. We do not accept costs for dismantling and installation nor for carriage. Replaced parts become our property. The warranty does not cover damage caused through: <ul style="list-style-type: none"><li>• normal wear and tear</li><li>• improper installation</li><li>• negligent care and maintenance</li><li>• improper initial and subsequent operation</li><li>• negligent or wanton destruction</li><li>• external influences such as fire, water, salts, alkaline solutions, acids, abnormal environmental influences</li><li>• mechanical damage through improper transport and fitting</li><li>• priming and other surface protection treatments</li><li>• incorrect or too late applied surface protection treatments</li><li>• repair by non-qualified persons</li><li>• using non-Hörmann parts without the approval of the manufacturer</li><li>• removal of the product number or making it unidentifiable</li></ul>

## Electric Operator Warranty

A separate 5 year warranty is granted on our electric operators. This includes operator mechanics, motor and motor control systems. A 2 year warranty is granted on radio equipment, accessories and system controls. There is no warranty on consumables (e.g. fuses, batteries, bulbs etc.). For further details please contact us on 01530 513030 or through our website on [www.hormann.co.uk](http://www.hormann.co.uk)

## User Information/Care

### Finish – Steel Doors

The coating process applied to the door and chassis is environmentally friendly. Minor scratches or marks are not covered under the conditions of our warranty and should be repaired immediately to prevent corrosion and deterioration of the panel. Corrosive substances such as acids, alkalines, and salts, etc. should be cleaned from the door immediately; failure to do so will result in deterioration of the finish, which will not be covered under our warranty. Should deterioration of the finish start to occur you will need to repaint your door immediately. Prepare the surface lightly with wet and dry. Then treat with solvent based 2 pack epoxy wash primer and a normal commercial paint (cellulose paint must not be used). Hörmann steel doors are a finished product. They do not require re-painting on site. They are however not immune to damage, which can occur at any stage of the handling of the product from factory to site.

### Finish – Timber Doors

Timber panels are coated with a neutralising base-stain. Doors must be stored upright, under cover, with wrapping intact, until wrapping is removed. As soon as the door is unwrapped, one coat of a good quality basecoat primer must be applied to both sides of the door. Immediately after installation, your timber doors require a further two coats of a good quality exterior wood finish on both sides. Initial application and periodic treatment should be carried out strictly in accordance with the woodstain manufacturer's instructions. Failure to follow these instructions will result in early deterioration of the timber panel.

### Finish – GRP Doors

GRP door panels should periodically be washed down using water. This should be done more frequently if fitted near the sea. Bird droppings will bleach the finish on GRP and should be removed using water as soon as possible. GRP doors should not be painted over.

### Paint Finish – Steel Doors

Minor surface damage can easily be repaired using touch up sprays or sticks without invalidating warranties.

The following document was designed by the Association of Garage Door Specialists, updated by the DHF and endorsed by all major UK garage door manufacturers, as a guide for purchasers of domestic garage doors.

## Visual appearance of Garage Doors

A new garage door can be a significant investment that will transform the appearance of your home. This information is a guide to the quality you can expect.

## The Quality Check

The quality check should be carried out in natural daylight, not direct sunlight. Stand at a distance of 3 metres from the door to view the overall appearance. The door is acceptable if, taking into account the facts below, none of the following are readily visible on the face of the door:

- Marks or distortion associated with the manufacturing process
- Minor indentations, marks or scuffs on the surface
- Paint or stain blemishes

## The Facts

### Steel Doors

**Panel Distortion** The rolling or pressing of steel panels during manufacture will cause distortion in the steel and while every effort is made to keep this to a minimum, inevitably some visible distortion will remain. The application of high gloss paints will make this slight distortion more apparent, especially under certain lighting conditions, such as car headlamps, or bright sunshine.

**Paint Finish** Primed doors – the primer coating is applied as a base coat only and as such requires additional finishing with a good quality exterior paint. Any marks or scratches on the primer coat should be rubbed down and repainted as part of this finishing process.

**Timber Doors** Finished doors – the factory application of the paint finish is an automated process and this may result in minor blemishes or slight inconsistencies in the paint, particularly in the area of panel joints.

### Timber

Timber is a natural product and there will be variations in pattern, colour, shading and grains. No two doors will be the same, because wood naturally expands and contracts according to environmental conditions, joints will open and close and some minor curvature may occur.

It is vital that timber doors are fully finished as per the manufacturers instructions before exposure to the elements.

### GRP and Composite Plastic Doors

**Mould Marks** GRP doors are individually handcrafted in a mould and are then hand finished. Some minor marks and blemishes will inevitably remain after this process.

**Translucency** When viewed from the inside, it is often possible to see variations in the translucency of the door, particularly around and between areas of relief. Such variations do not detract from the overall strength or build quality of the door.

### All Doors

**Colour Match** Pairs of doors should be ordered together to obtain the best colour match, bearing in mind the limitations of the materials used in the construction. Timber garage doors cannot be ordered as matching sets.

**Size Variation** As the size of a door changes in height and/or width, the panel frequency and profile can change, therefore doors of the same style but of different sizes can be significantly different in appearance.

**Clearances** All doors require operating clearances, i.e. the gap between the door panel and the frame opening, these are inbuilt during manufacture and should not be reduced by means of infills, or draughtproofing.

**Deflection** When in the open position, all doors will display a level of vertical deflection or “sag” across the width of the panel. Individual manufacturers' specifications should be consulted for exact tolerances.

### Power Operated Garage Doors

It is against the law to install a power operated garage door in the UK without complying with the Machinery Directive.

To comply with the Machinery Directive both the door and the operator used in the installation must have a Declaration of Incorporation from the manufacturer.

On completion of the installation the installer must provide a Declaration of Conformity and apply a CE mark giving details of the installation to the door/operator combination, which is now classed as a machine.

The installer must issue to the customer a Declaration of Conformity on completion of the installation.

The installer must hold copies of both the Declaration of Incorporation and the Declaration of Conformity on a technical file for inspection by the relevant authorities.

If any of the above requirements are not fulfilled the installation is illegal.

Please ensure for your own safety and peace of mind that whoever installs your electric operator is both willing and able to fulfil these requirements; if they are not – do not use them!

Members of the DHF Garage Door Installer Group can and will install your Hörmann operator safely and legally.

Since the company's policy is one of continuous improvement of its products, we reserve the right to make any alterations in design, manufacture or price. All business is governed by the company's Standard Conditions and this document does not form any part of any contract with the company and statements contained in it should not be construed as representations or warranties.

# Hörmann: Quality without Compromise



Hörmann KG Amshausen, Germany



Hörmann KG Antriebstechnik, Germany



Hörmann KG Brandis, Germany



Hörmann KG Brockhagen, Germany



Hörmann KG Dissen, Germany



Hörmann KG Eckelhausen, Germany



Hörmann KG Freisen, Germany



Hörmann KG Ichttershausen, Germany



Hörmann KG Werne, Germany



Hörmann Alkmaar B.V., Netherlands



Hörmann Legnica Sp. z o.o., Poland



Hörmann Beijing, China



Hörmann Tianjin, China

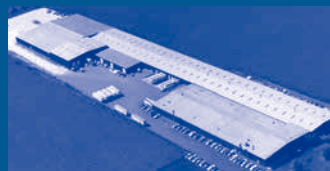

Hörmann LLC, Montgomery IL, USA



Hörmann Flexon LLC, Burgettstown PA, USA



Shakti Hörmann Ltd., India

Hörmann is the only manufacturer worldwide that offers you a complete range of all major building products from one source. We manufacture in highly-specialised factories using the latest production technologies. The close-meshed network of sales and service companies throughout Europe, and activities in the USA and Asia, make Hörmann your strong partner for first-class building products, offering “Quality without Compromise”.

**GARAGE DOORS**  
**OPERATORS**  
**INDUSTRIAL DOORS**  
**LOADING EQUIPMENT**  
**HINGED DOORS**  
**DOOR FRAMES**

Hörmann (UK) Ltd  
Gee Road  
Coalville  
Leicestershire  
LE67 4JW

Tel: 01530 513000  
Fax: 01530 513001

[www.hormann.co.uk](http://www.hormann.co.uk)

**HÖRMANN**