



Residential doors

Timber doors in premium carpenter quality
NEW: DesignLine Concepto linen

Discover a new feeling of home: high-quality residential doors

Our home is the centre of our life, our safe haven, our oasis of well-being.

As a family business, this spurs us on to provide products made in Germany to give you that special feeling of being at home. Our high-quality residential doors contribute to this and provide your home with that extra cosy feeling.

Whether classic or modern, white lacquer or beech, with glass elements or stainless steel embellishments – Hörmann offers you the residential door that suits you and your furnishings perfectly.





CONTENT

- 6 Good reasons to try Hörmann
- 12 Door leaf versions
- 14 BaseLine
 - Duradecor smooth
 - Duradecor texture
 - Lacquer
 - Real wood veneer
- 18 DesignLine Concepto
 - Ultra matt
 - Gloss
 - Slate
 - Linen ■ **NEW**
- 26 DesignLine
 - Stripe
 - Groove
 - Steel
 - Plain
 - Rail
 - Pure
- 42 ClassicLine
 - Georgia
 - Carolina
 - Montana ■ **NEW**
 - Kontura ■ **NEW**
 - Virginia
- 52 GlassLine
- 64 Function doors
- 68 Radio door lock operator SmartKey
- 70 Door operator PortaMatic
- 72 VarioFix steel frame
- 74 Sliding door versions
- 76 Glazing cut-outs / side elements / transom lights
- 78 Lever handles and fittings
- 81 Fittings for all-glass doors
- 82 Handles for sliding doors
- 84 Surface finishes
- 88 Door and frame design
- 90 Overview table
- 92 Technical data

Some of the doors shown are equipped with optional extras and do not always correspond to the standard models. The surface finishes and colours shown are subject to the limitations of the printing process and cannot be regarded as binding. All colours based on RAL.

All rights reserved. No part may be reproduced without our prior permission. Subject to changes.

How to find the right residential doors

There are several decisions to make when purchasing internal doors.

Which door leaf version should I choose?

Which material suits my style and needs?

So that you can see all the options when buying a door, we have listed the most important details that you should consider when deciding on residential doors:



Choosing the right surface finish

Most manufacturers offer internal doors with real wood veneers, paint or CPL coating. Especially in households with children and pets, it is worth choosing the very robust Duradecor surface. High-quality surfaces are also easy to clean. Tip: Ask your dealer about impact-resistant 4Protect edges, as these prevent unattractive flaws for a long time.

It's what's on the inside that counts

The choice of door inlay depends on how often the door is used and how durable a door is. A tubular chipboard insert offers the best value for money. Hörmann also offers high-quality composite timber door leaves as well as inexpensive tubular chipboard spacers and honeycomb inserts. For further information, see page 93.

Door leaf shape

You can choose between a rebated and a flush-closing door leaf. Rebated means that the edge of the door leaf rests on the frame a little when closed. Flush-closing means that the door leaf forms a level surface with the frame when closed. For further information, see page 12.

People with classic furnishings tend to choose the rebated version, while the flush version goes particularly well with a modern decorating style.

Type of fittings – lever handles, rose escutcheons and hinges

The lever handle sets are just as varied as the doors themselves and can be selected to suit your taste. Lever handle sets consist of a lever handle and rose escutcheon. Hörmann offers door handles and keyholes in many different shapes and stainless steel nuances. Glossy, matt or a combination of both: Simply choose the lever handle set to match your interior. Those who prefer a modern style can choose flush-fitting lever handles embedded in the door leaf – a particularly elegant appearance without drilled keyhole. Concealed hinges that invisibly connect the door leaf and door frame complement this perfectly.

Door frame

A timber frame can be chosen in angular or rounded versions to match the timber doors. In households with children, it is worth combining the internal doors with steel frames. These are especially robust and can withstand “accidents” with toy cars or run-ins with the vacuum cleaner or a crate of bottles. There is no visible difference between a VarioFix steel frame and a timber frame.



High-quality composite timber door leaf



Elegant, flush-fitting lever handle without drilled keyhole



Robust steel frame VarioFix

“A good reputation must be earned.”

August Hörmann

In keeping with the tradition started by the company's founder, the name Hörmann delivers brand name quality with extensive product expertise. The family business has over 80 years of experience as a construction component specialist and sees itself as your partner from the very beginning of building and renovation projects. It's no surprise that Hörmann is one of Europe's most successful internal door providers. All this makes Hörmann internal doors a reassuring purchase.



1 Quality products from Germany

All doors and frames are developed in-house by Hörmann. The doors are manufactured based on quality, environmental, energy and workplace safety management guidelines acc. to DIN EN ISO 9001, 14001, 50001 and BS OHSAS 18001 in a modern German factory. In addition, our highly qualified employees work intensively on new products, **continual further developments and improvements to details.** The results are patents and unique products on the market.



2 Internal doors for generations

We are convinced of our products and our uncompromising quality assurance. You can enjoy a Hörmann residential door for years to come **because you are literally choosing a “door for life”**.

3 An eye on the future

Hörmann is setting a good example. This is why the company obtains **100 % of its energy consumption from green sources**. Together with an intelligent and certified energy management system, CO₂-neutral mailing and the recycling of valuable materials, more than **40000 tons of CO₂ are saved each year**. And last but not least, Hörmann also offers products for sustainable construction.



4 Flush-fitting: Planar handle

For a **particularly elegant look**, equip your door with the Planar handle. Its **absolutely flush-fitting rose escutcheon**, perfectly recessed in the door leaf, certainly impresses fans of design, whilst perfect elegance is achieved by the flush-closing doors with concealed hinges. Another fine detail: The omission of the keyhole drill holes means the design looks even more reduced and therefore more elegant.

For further information, see page 80.

5 4 × 4-concept: DesignLine Concepto

Sophisticated and versatile: The doors of **the DesignLine Concepto offer you new design options for your home**. Combine the high-quality ultra matt, gloss (high-gloss), slate and the new linen surface finishes with the Traffic white, Light grey, Anthracite grey and the new Taupe colour variants.

Read more details about the easy-care and robust surface finishes from page 19.



6 Nano-coating: all-glass doors

Do you want a **light-flooded home**? Then our all-glass doors are the perfect choice for you. Apart from its elegant door appearance, the GlassLine also convinces with regard to ease of care: All styles with sand-blasted glass are equipped with nano-coating for fewer fingerprints.

Styles matching DesignLine Groove and Concepto

Matching all-glass doors are available for the DesignLine Groove and DesignLine Concepto styles for the perfect mix of timber and glass doors.

7 See and touch: Duradecor texture

The finely textured surfaces allow you to **feel what you see**. A wood grain texture is embossed into the door leaf, making the characteristic wood structure of the Duradecor texture surface tangible. This emphasises the **cosy and natural living atmosphere** in your home and is also extremely easy-care and hard-wearing.

For further information, see page 87.



8 Extremely impact-resistant: Duradecor surface

The high-quality surface will delight you: Duradecor features **maximum shock resistance that is 48 % better** than the average of the tested CPL surfaces from other manufacturers. It is also resistant, easy-care and heat-resistant, allowing you to enjoy your door for years to come.

For further information, see page 86.



9 Permanent resistance: 4Protect edge protector

Our rebated doors with angular edges and our flush-closing doors with Duradecor White lacquer, Light grey, Anthracite grey and Taupe surface finishes **are equipped as standard with the high-quality 4Protect edge protector.**

This makes your timber internal doors more resistant against everyday stress so you can enjoy them for many years to come.

For further information, see page 13.





10 High-quality and elegant: timber frame

Our timber frames impress with an **attractive round edge** and an **edge radius of 3 mm** **1**. The 25-mm-thick lining board **2** and the robust Duradecor surface **3** provide a **high-quality and elegant view** of your new residential door.

For further information, see pages 90 – 91.

11 Beautiful and robust: steel profile frame

VarioFix is the name of our steel profile frame, which offers you many advantages: With the adjustable decorative rebate, it is **fitted as simply** as a timber frame. It is also **extremely durable** thanks to its high strength. In terms of design, its elegant shape impresses without visible foldback. The VarioFix steel profile frame matches the timber frames, with a frame face of 55 mm perfectly **suited to timber frames**.



Rebated door leaf with rounded edges

Rebated version with round edges

If you value a harmonious overall view, you will make the right choice with this version: The door leaf rests on the frame and impresses with rounded door leaf edges in a **harmonious look**. The rebated door view with round edges is available for all timber internal doors, except DesignLine Stripe and ClassicLine Montana.

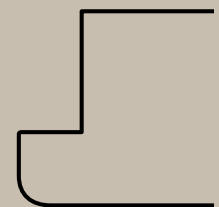

Horizontal view of door leaf



Rebated door leaf with angular edges and 4Protect edge protector

Rebated version with angular edges

If you appreciate a particularly streamlined look, then we recommend this version. The door leaf rests on the frame and has a **beautifully designed, angular edge**. It is available for all timber internal doors, except ClassicLine Virginia and ClassicLine Carolina. This version impresses in the Duradecor surface finishes with 4Protect edge protector and in the painted surface finish **with a perfect joint-free look**.

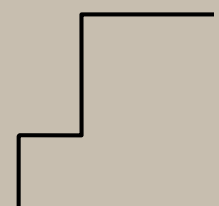

Horizontal view of door leaf



Flush-closing door leaf

Flush version

Would you love an **exclusive door view with a virtually flush-fitting transition** to the frame in your home? Then we recommend the flush-closing door leaf, which harmonises especially well with a modern home style. This version is available for all timber doors with the exception of ClassicLine Virginia and ClassicLine Carolina. This version impresses in the Duradecor surface finishes with 4Protect edge protector and in the painted surface finish with a **perfect joint-free look**.

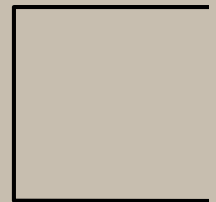

Horizontal view of door leaf



Perfect joint-free look for an extra high-quality door view

4Protect edge protector

The 4-fold edge protector for **flush-closing door and rebated doors with angular edges** in the Duradecor finish White Lacquer, Light grey, Anthracite, Taupe, White Parchment, Light grey Parchment, White Ash and Brushed White impresses with captivating features:

1. High impact resistance
2. High wear resistance
3. High scratch resistance
4. **Perfect joint-free look**, meaning that unlike conventional doors, no visible joints disturb the high-quality appearance of the door.



Conventional door leaf with visible joint



Timelessly elegant: BaseLine timber internal doors

Do you value the feel-good character in your home? Then the door models in the BaseLine series offer you the perfect selection. The door leaf in a flush or rebated version, combined with your preferred colour or your preferred decor creates a homely atmosphere that invites you to relax.

All BaseLine timber internal doors are available in the high-quality surfaces Duradecor smooth, Duradecor textured, lacquer and real wood veneer. There are a variety of colours and decors available for perfect harmony with your interior design style. For even more individuality, we offer you almost every preferred colour as a HPL surface finish. Or would you like to design your internal doors yourself? Then choose the paintable priming film. Discover all design possibilities on the next pages.













Duradecor smooth

The extremely impact-resistant Duradecor surface finish is the right choice for your home. Whether elegant White lacquer, modern grey or cosy timber decors, whether with or without glazing cut-out – you are sure to find an internal door to your taste. Our flush-closing doors and rebated doors with angular edges in the Duradecor White lacquer, Light grey, White Parchment, Light grey Parchment and White Ash surface finishes are equipped with the high-quality 4Protect edge protector as standard.

Colours and designs

-  White lacquer RAL 9016
-  Light grey RAL 7035
-  White Parchment
-  Light Grey Parchment
-  White Ash
-  Italian Acacia
-  Canadian Maple
-  French Beech

For further information, see page 86.

BaseLine

Duradecor
White lacquer RAL 9016

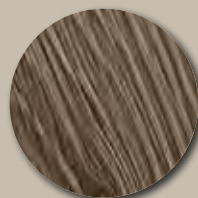

Duradecor texture

The Duradecor texture surface stylishly unites a feeling of real wood with ease of care. It represents the natural character of timber in a subtle way: A wood grain texture is embossed into the door leaf, making the characteristic wood structure tangible. Flush-closing doors and rebated doors with angular edges in the Duradecor textured surface finish Brushed White are equipped with the high-quality 4Protect edge protector as standard.

Decors

-  Grey Oak*
-  White Oak*
-  Wild Oak*
-  Raw Oak*
-  Dark Oak
-  Spanish Oak*
-  Walnut
-  Brushed Salted Oak
-  Brushed Pine
-  Brushed White ■ **NEW**

* also in horizontal grains

For further information, see page 87.

BaseLine

Duradecor texture
Brushed White ■ **NEW**



Lacquer

Timber internal doors with painted surfaces have an especially classic and high-quality effect. The Hörmann paint coating on a white Duradecor base plate ensures a uniform surface, joint-free look on the edges and a rich, vibrant colour.

Colours

- Traffic white RAL 9016
- Pure white RAL 9010
- Light grey RAL 7035
- Anthracite grey RAL 7016
- RAL to choose

For further information, see page 89.

BaseLine

Lacquer Pure white RAL 9010

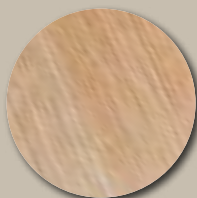

Real wood veneer

Natural, cosy, unique – Hörmann real wood veneers are produced from high-quality real timber and are truly unique.

Veneers

- Maple*
- Beech*
- Ash ■ **NEW**
- Limba ■ **NEW**
- Paintable Limba ■ **NEW**
- Mountain Oak ■ **NEW**
- American Oak* ■ **NEW**
- Knotted Oak* ■ **NEW**
- Matt lacquer Alpine Oak ■ **NEW**
- Oiled Oak in stressed timber ■ **NEW**
- American Walnut* ■ **NEW**
- Stained Oak ■ **NEW**
- Macore ■ **NEW**
- Mahogany ■ **NEW**

* also in horizontal grains



BaseLine

Real wood veneer matt lacquer
Alpine Oak
■ **NEW**

For further information, see page 89.



The 4 × 4-concept: DesignLine Concepto

DesignLine Concepto is the perfect choice for a modern interior design style. Four trend colours come in four elegant surface finishes, allowing you to realise individual room concepts in your own home – extremely stylishly.

Discover the huge choice of combination options.

For further information, see page 88.



	Traffic white	Light grey	Anthracite grey	Taupe ■ NEW
Ultra matt				
Gloss				
Slate				
Linen ■ NEW				

On the following pages, the doors in the rebated version are shown with hinges, but the flush-closing doors can be recognised by the invisible, concealed hinges.



Ultra matt

The particularly elegant silk matt Duradecor surface finish meets the highest demands both visually and haptically. Ultra matt combines the high resistance to fingerprints and soiling with a previously unattainable matt finish.

Doors with angular edges are equipped with the high-quality 4Protect edge protector as standard.

Colours

-  White
-  Light grey
-  Anthracite grey
-  Taupe ■ **NEW**

For further information, see page 88.

DesignLine Concepto
Ultra matt Anthracite grey

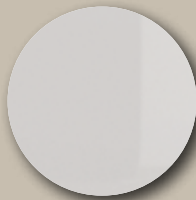

Gloss

Sparkling accents or an individual touch – with a high-gloss surface, you can do both: The crystal-look surface finish captivates with a unique brilliance. Light effects and reflections create an unmistakable ambience.

Colours

-  White
-  Light grey
-  Anthracite grey
-  Taupe ■ **NEW**

For further information, see page 88.

DesignLine Concepto
Light grey gloss



Slate

Experience the difference with all your senses: The extremely impact-resistant slate surface finish with a textured feel is the right choice if you prefer a modern and comfortable living design. The light-shadow contrast on the raised texture gives a very pleasant and natural appearance.

This variant is also available as an all-glass door.

Colours

-  White
-  Light grey
-  Anthracite grey
-  Taupe ■ **NEW**

For further information, see page 88.

DesignLine Concepto

Slate White

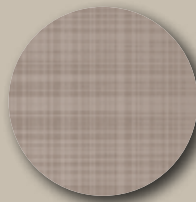

Linen ■ **NEW**

The new Duradecor surface Linen convinces with its fine, tactile texture. This design blends particularly well with wood shades and suits to a sophisticated, rustic-modern style of furnishing. At the same, the surface is robust and easy-care. The new Linen surface finish is available to choose as an all-glass door.

Colours

-  White
-  Light grey
-  Anthracite grey
-  Taupe ■ **NEW**

For further information, see page 88.

DesignLine Concepto

Linen Taupe, lever handles and hinges in black.edition ■ **NEW**

For harmonious
room concepts:
matching all-glass
doors



ConceptoGlass
■ NEW
Single-pane safety glass,
digital print
Linen White



ConceptoGlass
■ NEW
Single-pane safety glass,
digital print
Slate Anthracite grey

▼ Timber door DesignLine Concepto, Linen Taupe, rebated version





ConceptoGlass
 ■ NEW
 Single-pane safety glass,
 digital print
 Slate Taupe



ConceptoGlass
 ■ NEW
 Single-pane safety glass,
 digital print
 Slate Light grey



ConceptoGlass
 ■ NEW
 Single-pane safety glass,
 digital print
 Slate White

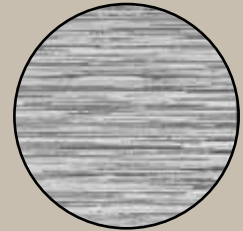

Slate texture for a
 modern, cosy home
 design



ConceptoGlass
 ■ NEW
 Single-pane safety glass,
 digital print
 Light grey linen



ConceptoGlass
 ■ NEW
 Single-pane safety glass,
 digital print
 Linen Anthracite grey



ConceptoGlass
 ■ NEW
 Single-pane safety glass,
 digital print
 Linen Taupe

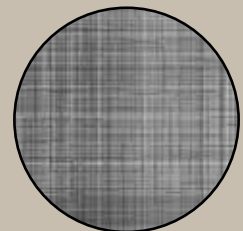

The discerning Linen
 design harmonises
 perfectly with the
 DesignLine Concepto
 Linen timber door

Sliding door – when is it worth it?

Anyone thinking about the interior design of a house or apartment has to decide which doors should be used in the individual rooms. Alongside classic internal doors with a door leaf that opens into the room, there are also space-saving sliding doors that run in front of or into the wall.

Such doors are especially practical if the available space in a room is not sufficient for a classic door. Sliding doors are real space-savers and represent practical convenience in your own home.



What are the advantages of sliding doors?

With sliding doors you gain more space in your home, if they run inconspicuously into the wall. Sliding doors are also available in many different designs to match your style of living.

What types of sliding doors are available?

Sliding doors for internal rooms are available in a range of designs to suit your living situation. There are two basic versions available, consisting either of one door (single-leaf) or two doors (double-leaf). Both versions can:

- Run into the wall
- Run in front of the wall

The brush seal included as standard from Hörmann and an inlet seal in the inlet box protect against odours from the kitchen, noise and draughts. Sliding doors can be equipped with a lock on request.

Applications for sliding doors

There are no limits to the imagination in the use of sliding doors. They are perfect for use as a flexible room divider and also give structure to spacious rooms. Sliding doors are also a practical solution for small apartments because there is no door leaf to swing into the room. A home office desk, for example, can be clearly separated from the living room with the help of sliding doors. Anyone who would like an open-plan kitchen without having cooking odours in the entire apartment can fit a sliding door between the kitchen and dining room. It is best to keep the door closed while cooking, then simply open it to serve and enjoy all of the advantages of an open kitchen. Fitted between the living room, dining room or hallway, a sliding door can protect against draughts; the glass version can also bath your home in bright, natural light.

Which design options are available for sliding doors?

At Hörmann you also have **numerous design options** in the area of sliding doors and can be sure to find the door that best suits your living style. Sliding doors are available in **single-leaf and double-leaf** versions for all door styles from the **BaseLine**, **DesignLine** and **GlassLine**.

If you like it timelessly elegant, we recommend the **BaseLine** doors. On the other hand, if you value special and individual equipment with stainless steel applications, recessed joints or high-quality coating, then you will find what you are looking for in the **DesignLine**. **GlassLine** sliding doors ultimately offer you more light and openness for your home.

Further information on Hörmann sliding doors can be found on pages 76 – 77.





For the door of your dreams: DesignLine

Create the door of your dreams with DesignLine. Whether style elements such as stainless steel embellishments, recessed joints or modern all-glass doors, whether real wood veneer or high-quality paint – the DesignLine offers a variety of door styles.

With the DesignLine residential doors and their different versions, discover the door that matches your home in terms of design, colour and decor.

For further information on surface finishes, colours and decors, see pages 86 – 89.





Duradecor smooth

White lacquer RAL 9016

For further information,
see page 86.

Stripe

The Stripe style with embossed grooves offers you a tasteful design with a little something extra. Flush-closing doors and rebated doors with angular edges are equipped with the high-quality 4Protect edge protector as standard.

Stripe 15

Duradecor

White lacquer RAL 9016

▼ **Timber door DesignLine Groove 15**, Traffic white lacquer, RAL 9016, rebated version, all-glass door DesignLine GrooveGlass 15









Groove

The grooves milled into the door leaf and the high-quality paint finish make the Groove style an elegant eye-catcher.

Colours

-  Traffic white RAL 9016
-  Pure white RAL 9010
-  Light grey RAL 7035
-  Anthracite grey RAL 7016
-  RAL to choose

For further information, see page 89.

Groove 11

Lacquer

Traffic white RAL 9016



Groove 15

Lacquer

Traffic white RAL 9016



GrooveGlass 15/10
with matt sections



GrooveGlass 15/5
with clear lines

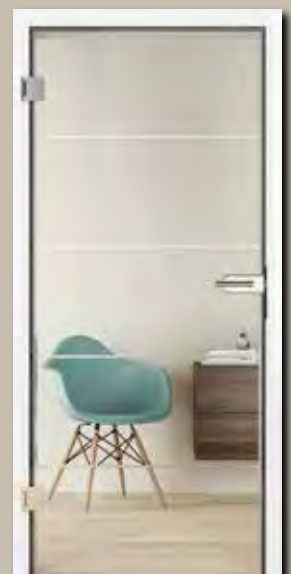

GrooveGlass 15/5
with matt lines



Groove 3 ■ NEW
Lacquer
Traffic white RAL 9016



Groove 13
Lacquer
Traffic white RAL 9016



GrooveGlass 13
with matt lines



Groove 18 ■ NEW
Lacquer
Traffic white RAL 9016



Groove 16
Lacquer
Traffic white RAL 9016



GrooveGlass 16
with clear edges



GrooveGlass 14
with matt lines



GrooveGlass 14
with clear lines



Groove 14
Lacquer
Traffic white RAL 9016







Groove 20
Lacquer
Traffic white RAL 9016



GrooveGlass 20
with matt lines

Lacquer

-  Traffic white RAL 9016
-  Pure white RAL 9010
-  Light grey RAL 7035
-  Anthracite grey RAL 7016
-  RAL to choose

For further information,
see page 89.

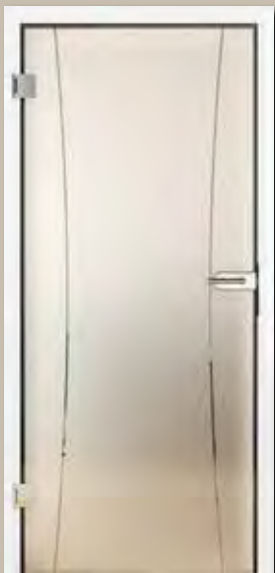

GrooveGlass 20
with clear lines



Groove 22 ■ NEW
Lacquer
Traffic white RAL 9016



Groove 19 ■ NEW
Lacquer
Traffic white RAL 9016



Groove 21
Lacquer
Traffic white RAL 9016



Groove 23
Lacquer
Traffic white RAL 9016



GrooveGlass 23
with matt line



Groove 29
Lacquer
Traffic white RAL 9016



GrooveGlass 29
with matt lines



GrooveGlass 29
with clear lines



GrooveGlass 29A
with matt line



GrooveGlass 23
with clear line



Groove 27 ■ NEW
Lacquer
Traffic white RAL 9016



Groove 31
Lacquer
Traffic white RAL 9016



Groove 34 ■ NEW
Lacquer
Traffic white RAL 9016



Groove 39 ■ NEW
Lacquer
Traffic white RAL 9016



Groove 44 ■ NEW
Lacquer
Traffic white RAL 9016







Groove 78 ■ NEW
Lacquer
Traffic white RAL 9016



GrooveGlass 78 ■ NEW
with clear line

Lacquer

-  Traffic white RAL 9016
-  Pure white RAL 9010
-  Light grey RAL 7035
-  Anthracite grey RAL 7016
-  RAL to choose

For further information,
see page 89.



Groove 49 ■ NEW
Lacquer
Traffic white RAL 9016



Groove 51 ■ NEW
Lacquer
Traffic white RAL 9016



GrooveGlass 51 ■ NEW
with clear line



Groove 53 ■ NEW
Lacquer
Traffic white RAL 9016



Groove 50 ■ NEW
Lacquer
Traffic white RAL 9016



Groove 55 ■ NEW
Lacquer
Traffic white RAL 9016



Groove 56 ■ NEW
Lacquer
Traffic white RAL 9016



Groove 54 ■ NEW
Lacquer
Traffic white RAL 9016



Groove 85
Lacquer
Traffic white RAL 9016



GrooveGlass 85 ■ NEW
with clear lines



Groove 86 ■ NEW
Lacquer
Traffic white RAL 9016



Groove 87 ■ NEW
Lacquer
Traffic white RAL 9016



Groove 88 ■ NEW
Lacquer
Traffic white RAL 9016





Groove 89 ■ NEW
Lacquer
Traffic white RAL 9016



Groove 92 ■ NEW
Lacquer
Traffic white RAL 9016

Lacquer

-  Traffic white RAL 9016
-  Pure white RAL 9010
-  Light grey RAL 7035
-  Anthracite grey RAL 7016
-  RAL to choose

For further information,
see page 89.



Steel

The Steel style represents a modern design through the surface-mounted embellishments in stainless steel look. Our flush-closing doors and rebated doors with angular edges in the Duradecor White lacquer, Light grey, White Parchment, Light grey Parchment, White Ash and Brushed White surface finishes are equipped with the high-quality 4Protect edge protector as standard.

Steel 14

Duradecor
White lacquer RAL 9016



Steel 16

Duradecor
White lacquer RAL 9016



Steel 20

Duradecor
White lacquer RAL 9016



Steel 23

Duradecor
White lacquer RAL 9016



Steel 27

Duradecor
White lacquer RAL 9016



Steel 29
Duradecor
White lacquer RAL 9016



Steel 37
Duradecor
White lacquer RAL 9016



Steel 38
Duradecor
White lacquer RAL 9016



Steel 39
Duradecor
White lacquer RAL 9016











Steel 44
Duradecor
White lacquer RAL 9016













Steel 78
Duradecor
White lacquer RAL 9016

Duradecor smooth

-  White lacquer RAL 9016
-  Light grey RAL 7035
-  White Parchment
-  Light Grey Parchment
-  White Ash
-  Italian Acacia
-  Canadian Maple
-  French Beech

Duradecor texture





-  Grey Oak*
-  White Oak*
-  Wild Oak*
-  Raw Oak*
-  Dark Oak
-  Spanish Oak*
-  Walnut
-  Brushed Salted Oak
-  Brushed Pine
-  Brushed White ■ **NEW**

* also in horizontal grains

Duradecor ultra matt

-  White
-  Light grey
-  Anthracite grey
-  Taupe ■ **NEW**

Lacquer

-  Traffic white RAL 9016
-  Pure white RAL 9010
-  Light grey RAL 7035
-  Anthracite grey RAL 7016
-  RAL to choose

For further information,
see from page 86.



Plain

The Plain style creates elegant accents with inlaid and therefore flush-fitting embellishments in stainless steel look. Our flush-closing doors and rebated doors with angular edges in the Duradecor White lacquer, Light grey, White Parchment, Light grey Parchment, White Ash and Brushed White surface finishes are equipped with the high-quality 4Protect edge protector as standard.

Plain 14-7

Duradecor

White lacquer RAL 9016

▼ **Timber door DesignLine**, Plain 29-7 Duradecor White lacquer RAL 9016 and jack knife door BaseLine in Duradecor White lacquer RAL 9016





Plain 23-7
Duradecor
White lacquer RAL 9016



Plain 27-7
Duradecor
White lacquer RAL 9016











Plain 29-7
Duradecor
White lacquer RAL 9016













Plain 37-7
Duradecor
White lacquer RAL 9016

Duradecor smooth





-  White lacquer RAL 9016
-  Light grey RAL 7035
-  White Parchment
-  Light Grey Parchment
-  White Ash
-  Italian Acacia
-  Canadian Maple
- 

Duradecor texture

-  Grey Oak*
-  White Oak*
-  Wild Oak*
-  Raw Oak*
-  Dark Oak
-  Spanish Oak*
-  Walnut
-  Brushed Salted Oak
-  Brushed Pine
-  Brushed White **NEW**

* also in horizontal grains

Lacquer

-  Traffic white RAL 9016
-  Pure white RAL 9010
-  Light grey RAL 7035
-  Anthracite grey RAL 7016
-  RAL to choose

For further information,
see from page 86.



Rail 2
Duradecor White lacquer
RAL 9016

















Rail 1
Duradecor White lacquer
RAL 9016





Rail

The timber and glass combination Rail is recommended as the perfect complement to the DesignLine timber door styles.









Glass variants

-  Clear
-  Satinato
-  Solid silkscreen
-  Wave
-  Raff
-  Jil
-  Lines
-  Gisa
-  Gropus clear
-  Gropus matt
-  GrooveGlass 15 clear
-  GrooveGlass 15 matt
-  GrooveGlass 29 clear
-  GrooveGlass 29 matt

-  Clear glass
-  Matt glass
-  Design glass

For further information,
see pages 54 – 65.

Duradecor smooth







-  White lacquer RAL 9016
-  Light grey RAL 7035
-  White Parchment
-  Light Grey Parchment
-  White Ash
-  Italian Acacia
-  Canadian Maple
-  French Beech

Duradecor texture

-  Grey Oak*
-  White Oak*
-  Wild Oak*
-  Raw Oak*
-  Dark Oak
-  Spanish Oak*
-  Walnut
-  Brushed Salted Oak
-  Brushed Pine
-  Brushed White ■ **NEW**

* also in horizontal grains

Lacquer

-  Traffic white RAL 9016
-  Pure white RAL 9010
-  Light grey RAL 7035
-  Anthracite grey RAL 7016
-   RAL to choose

For further information,
see from page 86.



Pure

With its recessed, streamlined glass element over the entire door leaf height, the Pure style certainly impresses.

Pure centre

Duradecor White lacquer RAL 9016



Pure hinge side









Duradecor
White lacquer RAL 9016



Pure lock side

Duradecor
White lacquer RAL 9016

Duradecor smooth





-  White lacquer RAL 9016
-  Light grey RAL 7035
-  White Parchment
-  Light Grey Parchment
-  White Ash
-  Italian Acacia
-  Canadian Maple
-  French Beech

Duradecor texture

-  Grey Oak*
-  White Oak*
-  Wild Oak*
-  Raw Oak*
-  Dark Oak
-  Spanish Oak*
-  Walnut
-  Brushed Salted Oak
-  Brushed Pine
-  Brushed White **NEW**

* also in horizontal grains

Lacquer

-  Traffic white RAL 9016
-  Pure white RAL 9010
-  Light grey RAL 7035
-  Anthracite grey RAL 7016
-  RAL to choose

For further information,
see from page 86.



For fans of classic and elegance: ClassicLine

Do you want a classic look that's also modern? Then our timeless ClassicLine styles are the perfect choice for you. Discover your favourite door for the perfect country house style.

All styles in this series convince with handcrafted details in the best carpenter's quality:

The particularly high-quality doors Georgia with their inlaid profile strip. The Carolina styles with embossed profiling, the new Montana with high-quality reconditioned frames, the new Kontura styles with contour-milled profiles and the Virginia panel doors with their elegant design.

The same applies to the ClassicLine: Depending on the door version, you can choose between the Duradecor smooth and the Duradecor textured, lacquer or decor finishes as well as many colours and decors.

For further information, see pages 86 – 89.



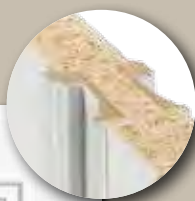



Georgia

The high-quality profile strip for the Georgia door style is inlaid into grooves in the door leaf using the best carpentry tradition, lending these styles an elegant appearance.

Georgia 1

Duradecor White lacquer RAL 9016

Duradecor smooth

-  White lacquer RAL 9016
-  White Ash
-  Italian Acacia

Duradecor texture

-  Grey Oak*
-  White Oak*
-  Wild Oak*
-  Raw Oak*
-  Dark Oak
-  Brushed Salted Oak
-  Brushed Pine

* also in horizontal grains

Lacquer

-  Traffic white RAL 9016

For further information, see from page 86.



Georgia 2

with glazing cut-out
Duradecor
White lacquer RAL 9016



Georgia 3

Duradecor
White lacquer RAL 9016



Georgia 4

with glazing cut-out
Duradecor
White lacquer RAL 9016



Georgia 5

Duradecor
White lacquer RAL 9016

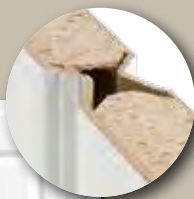

Carolina

The panel frames of the Carolina door styles are created by an embossed profile in the door leaf. The high-quality paint coating means you can enjoy a smooth, brilliant colour surface.

Lacquer

 Traffic white RAL 9016

For further information, see page 89.

Carolina 5

Lacquer
Traffic white RAL 9016



Carolina 1
with glazing cut-out LA 2
Lugano
Lacquer
Traffic white RAL 9016



Carolina 2
Lacquer
Traffic white RAL 9016



Carolina 4
with glazing cut-out LA
rail 2 / 3
Lacquer
Traffic white RAL 9016



Carolina 5
with glazing cut-out LA 3
Lacquer
Traffic white RAL 9016



Montana ■ NEW

For styles from the Montana series, high-quality frames emphasise the simple elegance. The reduced design language matches both a classic and modern interior style.

Lacquer

 Traffic white RAL 9016

For further information, see page 89.

Montana 4
with glazing cut-out
Lacquer
Traffic white RAL 9016



Montana 1
with glazing cut-out
Lacquer
Traffic white RAL 9016



Montana 2
Lacquer
Traffic white RAL 9016



Montana 3
Lacquer
Traffic white RAL 9016



Montana 5
Lacquer
Traffic white RAL 9016



▲ Timber door **ClassicLine Montana 4**, Traffic white lacquer RAL 9016, rebated version



Montana 6
with glazing cut-out
Lacquer
Traffic white RAL 9016



Montana 7
Lacquer
Traffic white RAL 9016



Montana 7
with glazing cut-out
Lacquer
Traffic white RAL 9016







Montana 8
Lacquer
Traffic white RAL 9016



Kontura ■ NEW

The Kontura series door styles have a special charm with contour-milled profiles in combination with the indicated V-groove.

Lacquer

-  Traffic white RAL 9016
-  Pure white RAL 9010
-  Light grey RAL 7035
-  Anthracite grey RAL 7016
-  RAL to choose

For further information, see page 89.

Kontura 2

Lacquer
Traffic white RAL 9016

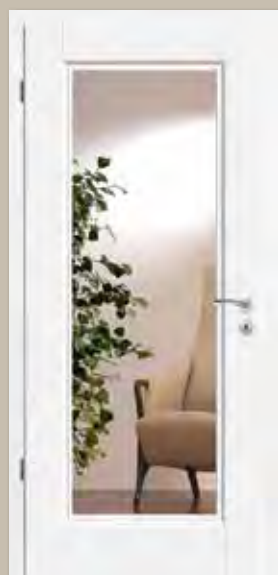

Kontura 1
with glazing cut-out LA 2 1
Lacquer
Traffic white RAL 9016



Kontura 3
with glazing cut-out LA
Lacquer
Traffic white RAL 9016



Kontura 4
Rail 1/3
Lacquer
Traffic white RAL 9016



Kontura 5
Lacquer
Traffic white RAL 9016



Kontura 6
with glazing cut-out LA 2
Lacquer
Traffic white RAL 9016



Kontura 7
Lacquer
Traffic white RAL 9016



Kontura 12
Lacquer
Traffic white RAL 9016



Kontura 12
with glazing cut-out LA
Lacquer
Traffic white RAL 9016

▼ **Timber door ClassicLine Kontura 2**, Traffic white lacquer RAL 9016





Virginia

This classic door version, also called a panel door, consists of a frame construction with up to 3 friezes. The sections can be filled either with a glazing or a timber board.

Decor

 White lacquer similar to RAL 9016

Virginia 3

White lacquer decor with 3 window sections



Virginia 1

White lacquer decor



Virginia 1

White lacquer decor with 1 window section



Virginia 2

White lacquer decor



Virginia 2

White lacquer decor with 1 window section



▲ Timber door ClassicLine Virginia 3, White lacquer decor, rebated version

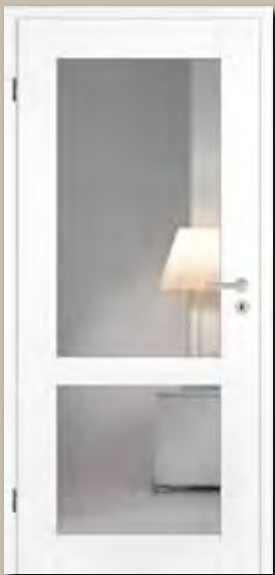

Virginia 2
White lacquer decor
with 2 window sections



Virginia 3
White lacquer decor



Virginia 3
White lacquer decor
with 1 window section



Virginia 3
White lacquer decor
with 2 window sections



More light for your home: GlassLine

GlassLine doors offer you many clear advantages: Glass doors are upmarket and chic, contributing an open design for your home and lending each room a particular charm.

Discover the design that best suits your home and choose between hinged doors, all-glass doors with timber frames or sliding doors.

Special and very individual accentuation is set with the new tinted styles, which give your glass door a striking colour nuance.



Sand-blasting

If you value individuality: The sandblasting technique draws delicate designs in the glass surface. The matt surface finish with nano-coating guarantees fewer fingerprints.



Aldo
Single-pane safety glass, sand-blasted, with clear stripes



Amra ■ NEW
Single-pane safety glass, sand-blasted, with matt stripes



Bamante
Single-pane safety glass, sand-blasted, with clear sections and matt stripes



City ■ NEW
Single-pane safety glass, sand-blasted, with matt sections

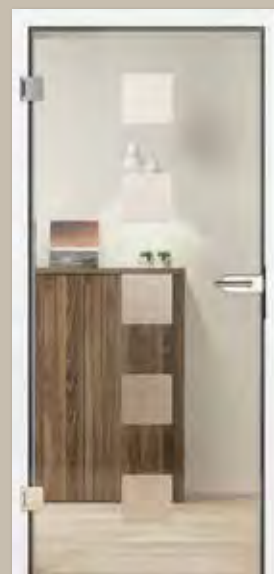

Corbus
Single-pane safety glass, sand-blasted, with matt rectangles



Corbus
Single-pane safety glass, sand-blasted, with clear rectangles

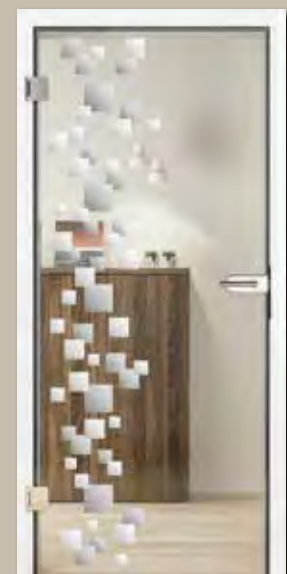

Cube ■ NEW
Single-pane safety glass, sand-blasted, with matt sections



Graphic
Single-pane safety glass,
sand-blasted, with matt
stripes



Graphic ■ NEW
Single-pane safety glass,
sand-blasted, with clear
stripes



Jada
Single-pane safety glass,
sand-blasted, with clear
and matt stripes



Jil
Single-pane safety glass,
sand-blasted, with matt
stripes



Jil ■ NEW
Single-pane safety glass,
sand-blasted, with clear
stripes



Liko
Single-pane safety glass,
sand-blasted, with matt
stripes



Liko ■ NEW
Single-pane safety glass,
sand-blasted, with clear
stripes



Lilu ■ NEW
Single-pane safety glass,
sand-blasted, with matt
stripes



Luba ■ NEW
Single-pane safety glass,
sand-blasted, with matt
stripes

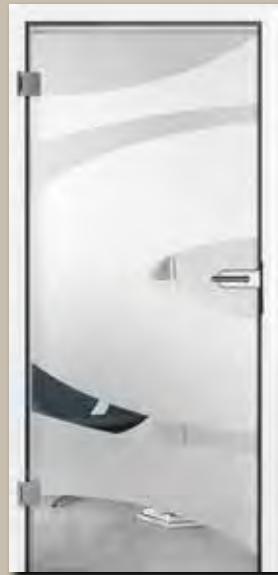

Meda ■ NEW
Single-pane safety glass,
sand-blasted, with clear
stripes



Memory ■ NEW
Single-pane safety glass,
sand-blasted, with clear
squares

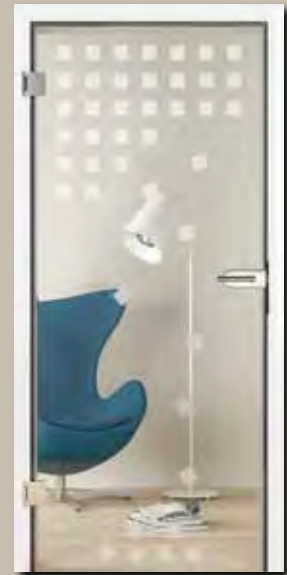

Memory ■ NEW
Single-pane safety glass,
sand-blasted, with matt
squares

▼ All-glass door GlassLine Raff





Milton ■ NEW
Single-pane safety glass,
sand-blasted, with matt
stripes



Milton ■ NEW
Single-pane safety glass,
sand-blasted, with clear
stripes



Nubia
Single-pane safety glass,
sand-blasted, matt
surfaces blend into clear
surfaces



Pinta ■ NEW
Single-pane safety glass,
sand-blasted, with matt
sections



Privat
Single-pane safety glass,
sand-blasted, style to
choose, shown: with clear
text



Raff
Single-pane safety glass,
sand-blasted, with clear
style



Raff ■ NEW
Single-pane safety glass,
sand-blasted, with matt
style (optionally in
silkscreen)



Saha
Single-pane safety glass,
sand-blasted, with matt
stripes



Wave
Single-pane safety glass,
sand-blasted, with clear
style (optionally in
silkscreen)



Wave ■ NEW
Single-pane safety glass,
sand-blasted, with matt
style



Wildlife
Single-pane safety glass,
sand-blasted, with matt
stripes



Wildlife ■ NEW
Single-pane safety glass,
sand-blasted, with clear
stripes

▼ All-glass door GlassLine Satinato as sliding door system Rotan





Laser technique

This glass finish offers fine details and shading. The depth effect creates fascinating effects, which are further enhanced by the brilliance of the all-glass door.



Agesa

Single-pane safety glass, laser technique, with matt stripes



Aino ■ NEW

Single-pane safety glass, laser technique, with matt stripes



Lines

Single-pane safety glass, laser technique, with matt stripes



Lito

Single-pane safety glass, laser technique, with matt text



Silkscreen

Design is united with the highest quality surface embellishment: The particularly scratch-resistant surface is easy to clean and resistant to soiling.



Batista ■ NEW

Single-pane safety glass, silkscreen, with matt and clear stripes



Lou ■ NEW

Single-pane safety glass, silkscreen, with matt circles



Rika

Single-pane safety glass, silkscreen, with matt rectangles



Solid silkscreen ■ NEW

Single-pane safety glass, silkscreen, solid matt



Yoko ■ NEW

Single-pane safety glass, silkscreen, with clear stripes



Fluted glass

The fluted glass on the glass door is created by a fine V-groove. A clear or satin-finished glass is used depending on the preferred opaqueness. The fluted glass convinces with special patterns, its tactile feel and the extraordinary play of light produced by the prism effect.



Coco
Single-pane safety glass,
Satinato with fluted glass



Gropus
Single-pane safety glass,
Satinato with fluted glass



Velita ■ NEW
Single-pane safety glass,
clear with fluted glass



Coco
Single-pane safety glass,
clear with fluted glass



Gropus ■ NEW
Single-pane safety glass,
clear with fluted glass



Velita ■ NEW
Single-pane safety glass,
Satinato with fluted glass



Clear ■ NEW
Laminated safety glass,
clear inside film



Black ■ NEW
Laminated safety glass,
coloured inside film



Satinato look ■ NEW
Laminated safety glass,
matt inside film



White ■ NEW
Laminated safety glass,
coloured inside film



Clear ■ NEW
Single-pane safety glass

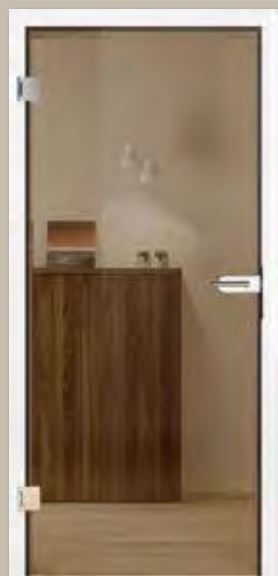

Clear bronze ■ NEW
Single-pane safety glass,
tinted

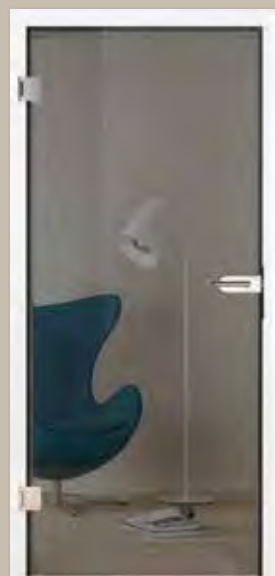

Clear grey ■ NEW
Single-pane safety glass,
tinted

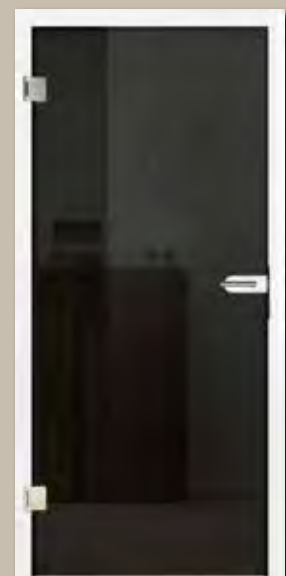

Dark Grey ■ NEW
Single-pane safety glass,
tinted

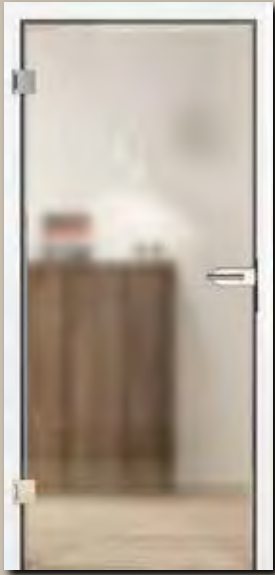

Mastercarré ■ NEW
Single-pane safety glass,
Mastercarré



Satinato ■ NEW
Single-pane safety glass,
Satinato



Glass type clear

With this type of glass, the glass door creates a subtle, interesting contrast. The iron oxide in the glass produces a slight “green shimmer” meaning that the view of the glass door and the interior appear in a “different light”.



Mirastar ■ NEW
Single-pane safety glass,
mirrored and translucent
look on both sides



Glass type Clear White

Glass doors with the Clear White glass type appear in radiant white. The design in Satinato look is particularly effective on design glass and Clear White is our recommendation also in the versions with laminated safety glass and internal white film.



Intelligent functions for more security and convenience

Your apartment entrance door can be equipped with many additional functions at Hörmann: Acoustic insulation, fire and smoke protection as well as additional security features such as a spyhole or an automatic door opener can be selected for many styles.

You can increase your everyday living comfort with innovative solutions such as the SmartKey radio door lock operator. You can open your door easily at the push of a button with your handheld transmitter, radio internal push button, the BiSecur app on your smartphone or directly via the sensor field on the SmartKey.

The PortaMatic door operator is recommended for everyone who is physically disabled or would simply like more convenience. Automatically closing and opening the doors via a hand transmitter or button means improving your quality of life – thanks to Hörmann.



Hörmann apartment entrance doors and fire-rated doors offer more:

More functions than conventional doors. Equip your new Hörmann door to meet your individual needs with important additional functions such as fire protection, acoustic insulation or other security elements. In addition, Hörmann supplies wet and damp room doors, jack knife and double-action doors as well as hatches.



Climatic class 3

Doors in this class feature a special door leaf design, which balances the temperature and moisture variations between rooms with different uses, such as between an unheated cellar and a warm hallway. The effect: energy savings and protection against door warpage.



Acoustic insulation

Acoustic-rated doors are in demand in places where it can be very loud in apartments or offices. The connection between the door and frame is crucial. It is an essential component for guaranteeing the required acoustic insulation.

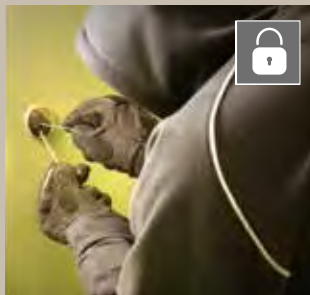

Security







Suitable special functions can significantly reduce the risk of break-in. Hörmann recommends the resistance class RC 2 or better RC 3 for apartment entrance doors.



Fire protection

Fire protection can save lives! A suitably equipped door can protect against penetrating flames (for at least 30 or 90 minutes), but also prevent the penetration of dangerous combustion gases. Fire and smoke-rated elements are only available as a complete package which includes the frame and all fittings.

Climate and apartment entrance doors

Functions	WAT system 1*	WAT system 2	WAT system 3
Door thickness	40 mm	46 mm	52 mm
Max. dimensions	2110 × 985 mm	2235 × 1110 mm	2485 × 1235 mm**
 Climatic class 3	●	●	●
 Acoustic rating category 1	●		
 Acoustic rating category 2		●	
 Acoustic rating category 3		●	●
 RC 2 security equipment			●
 RC 3 security equipment			●

* Not possible for: Groove Lacquer, Steel Concepto / Lacquer, Plain Duradecor / Lacquer

** with RC 3: 2235 × 1110 mm

● = Standard equipment



Spyhole

A must for greater safety: With a spyhole, you can see who is standing in front of your door at any time without having to open it.



Electric strike

With the electric strike catch, you can conveniently open your door via a switch inside the home.



Motor lock

This allows you to lock your entrance door automatically – practical, convenient and safe.



Protective fitting ES 2

Optionally for RC 2 security equipment



Linkage door closer

As standard for single-leaf fire-rated doors



Side rail door closer



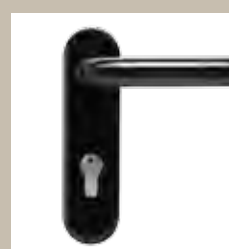





As standard for double-leaf fire-rated doors, optional for single-leaf fire-rated doors



Fire-protection lever

(Profile cylinder not included in the scope of delivery)

Fire-rated doors

Functions	Smoke-tight door*	T30 fire-rated door**	T90 fire-rated door***
Door thickness	40 mm	50 mm	70 mm
Max. dimensions	2110 × 985 mm	2235 × 1235 mm	2485 × 1235 mm
 T30 fire-retarding		●	
 T90 fire-proof			●
 Smoke protection	●	○	○
 Climatic class 2		●	●
 Climatic class 3		○	○
 Acoustic rating category 1		○	○
 Acoustic rating category 2	●	○	○
 RC 2 security equipment		○	○
 RC 3 security equipment			○

* Not possible for: Concepto, Stripe, Groove Lacquer, Steel Concepto / Lacquer, Plain Duradecor / Lacquer

** Not possible for: Stripe, Steel Concepto

*** Not possible for: Concepto, Steel Concepto / Lacquer, Stripe, Groove Lacquer, Plain Duradecor / Lacquer

● = Standard equipment

○ = Optional equipment

Radio door lock operator SmartKey

Easily open your door lock at a press of a button with your hand transmitter, radio internal push button, BiSecur app on your smartphone* or directly via the sensor field on the SmartKey. No need to set down your groceries in order to open your entrance and apartment door. Even with a walker, wheelchair or pram, it is much easier to enter your house or apartment, because you can open the door from a distance. Locking takes place either by pressing a button or automatically after a specified period of time. This securely locks your door and provides protection against burglary.



The inexpensive radio door lock operator SmartKey is available in white or silver, incl. hand transmitter HSE 4 SK BS with labelled buttons.



High level of operating comfort

- Locking or unlocking the door
- Opening the door (the door latch is retracted for a defined time and the door can be easily pushed open) **1**
- Operation via hand transmitter, radio internal push button or BiSecur app **2**
- Automatic comfort locking, either after 30, 60 or 120 s or with a delay after pressing a button **3**
- Manual opening and closing possible at any time, in case of emergency** (from the outside using an ordinary key, from the inside using a hand wheel)

Secure control

- Acoustic / visual feedback on the operator, if the door lock was locked / unlocked or opened
- Enquiry on the optional hand transmitter HS 5 BS or radio internal push button FIT 5 to determine whether the door is locked or unlocked – you no longer have to go to the door in the evening to check whether it is locked. **4**
- BiSecur radio system with extremely secure encryption protocol
- Idle mode with deactivated radio

Ideal for retrofitting

- Flexible fitting by clamping, gluing or screwing on the interior of the door
- No damage to the door or frame (ideal for rental apartments)
- Simply attach to the inserted key***
- Wireless installation thanks to battery operation (lifecycle approx. 1 year**** for 8 cycles per day)



Door lock is locked



Door lock is unlocked

* Optional BiSecur Gateway required

** Cylinder with emergency and hazard function required

*** Cylinder projection of 7 – 12 mm necessary on the inside, the key head must be shortened to a length of 4 – 7 mm

**** Depends on the door or lock's ease of movement as well as the batteries used!

Open and close doors effortlessly

With Hörmann door operator PortaMatic, you can open and close your timber and steel internal doors automatically via hand transmitter or button. Whether you are physically disabled or would simply like more convenience – this technology will make your everyday life easier. The door operator PortaMatic features not only an array of functions and settings, but also minimal power consumption. In addition, the PortaMatic is up to 25 % cheaper than similar door operators and can be subsidised up to 100 % by your nursing care insurance.

Find out more about support options at <http://www.hoermann.de/portamatic/zuschuss>

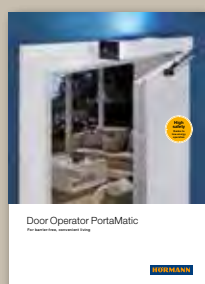

For additional information, consult the PortaMatic door operator brochure.



Senior-friendly residences

Would you like to stay mobile despite physical limitations? The PortaMatic operator for internal doors improves your quality of life by helping you move about your home unaided.

Convenient living

You can now carry full trays, heavy crates of beverages or your shopping bags into your rooms unhindered. You will never want to do without this convenience ever again.

Barrier-free working

Barrier-free working is already of great importance and will become even more significant in the future. The PortaMatic door operator can be easily integrated into all non-public areas at your workplace, thus ensuring more convenience.

Hygienic door operation

In office buildings, the risk of infection among employees is especially high on doors leading to the lavatory. In combination with a non-contact switch, the PortaMatic door operator provides reliable protection from germs and bacteria, giving you a sense of security.



The robust steel frame VarioFix

In addition to the standard timber frames, all our apartment entrance doors are also available with the steel frame VarioFix. It is the ideal solution for apartment entrance doors and internal doors in the home and project sector where high resistance and durability are necessary.

The VarioFix frame harmonises perfectly with other timber frames due to the frame face of 55 mm on both sides. This way, you can also use doors with different frames in one room or house.

For the steel frame VarioFix, wall tolerances of up to 20 mm are no problem. The adjustable decorative rebate easily compensates for different wall thicknesses during renovations and new construction projects.

The VarioFix frame is available in Traffic white RAL 9016 to match our door leaves in Duradecor White lacquer, White lacquer and RAL to choose.



The frame face of 55 mm on both sides of the VarioFix frame (fig. left) harmonises very well with timber frames (fig. right).



The VarioFix frame is especially robust and can withstand "accidents" with toy cars or run-ins with the vacuum cleaner.



The VarioFix frame is also suited for apartment entrance doors with RC 2 security equipment and acoustic insulation.

VarioFix: the steel frame with many benefits

Especially resistant to damage **1**

The robust VarioFix frame can also take a collision with a toy car or your vacuum cleaner. In such cases, edges on timber frames can be damaged or even chipped.

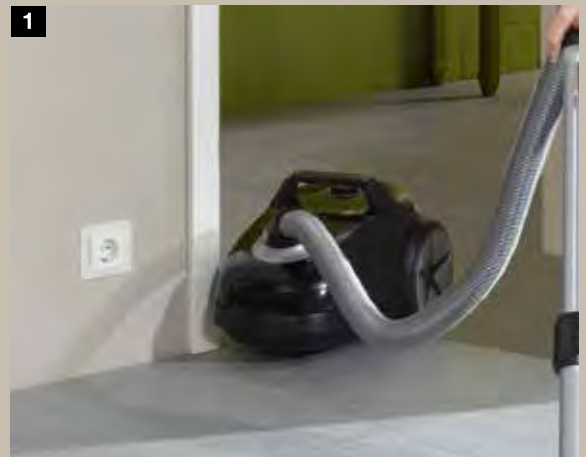

Resistant to cleaning water **2**

The VarioFix frame is the perfect solution for rooms with tiled floors. Thanks to the high-quality galvanization, even cleaning water cannot damage the frame. With timber frames there is a danger that the bottom frame edge will swell or that it must be sealed with an unattractive silicone joint.



Invisible mitre cut **3**

For the powder-coated steel frame VarioFix, the corner joints feature high-quality welding and a flush polish, meaning there are no visible mitre cuts in the frame corners, in contrast to timber frames.

Uniform gap dimension for flush-closing doors **4**

Due to the stable steel construction, the VarioFix frame cannot warp after fitting. This guarantees a uniform gap dimension for flush-closing doors and ensures a harmonious and elegant door appearance.

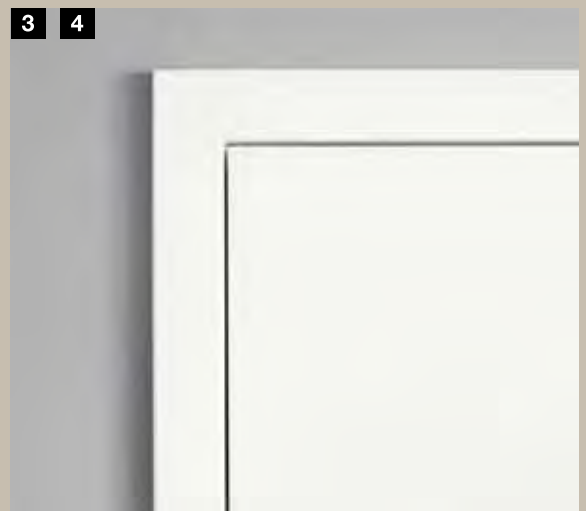

Our space-saving marvels: sliding doors

Sliding doors open up new possibilities for ideal use of your living space.

Hörmann offers single-leaf and double-leaf sliding door solutions for every living situation. All door styles in the BaseLine, DesignLine and GlassLine ranges are available as sliding doors.



Sliding door system in the frame

When fitted in front of the wall, the door leaf slides on two tracks mounted in the sliding door box. When fitted running within the wall, the tracks are fitted in an on-site door pocket in the wall. This eliminates the sliding door box. The wall opening is concealed by the frame.



With the brush on the door leaf (figure on left) and the optional inlet seal in the frame (figure on right), Hörmann sliding doors with frame type C running in front of the wall offer optimal protection against odours, noise and draughts – for even more comfort in your own home.



Sliding door system Slide Compact

With this system, the door leaves slide in a guide rail profile. The profile in a stainless steel colour can be fitted both in front of the wall and on the ceiling. For a door leaf weight of up to 60 kg, the Slide Compact system is equipped with a SafeClose in order to gently close the door leaves.



Sliding door system Rotan

In this trendy industrial-style sliding door system, the doors are mounted on support brackets that slide over rollers on a track rail. The stainless steel rail is fitted on the wall.



Sliding door system Slide Compact with additional vertical stop for single-leaf doors, running in front of the wall ■ **NEW**



The profile is also available in matt black, including the handle bars. For further information, see page 84.



Cool chic, elegant function: With the sliding door system Rotan, the support brackets slide over rollers on the track rail.

Glazing cut-outs

With our selection of glazing cut-outs, you can take your favourite style and make the personalised door of your dreams. Glazing cut-outs are available in the glazing of your choice.

Side elements and transom lights

Side elements and transom lights flood your living spaces with light for that special flair. While side elements visually enhance the door sets, transom lights emphasise the room height. Transom panels underscore the ceiling-high appearance of the door set.



Glazing cut-outs

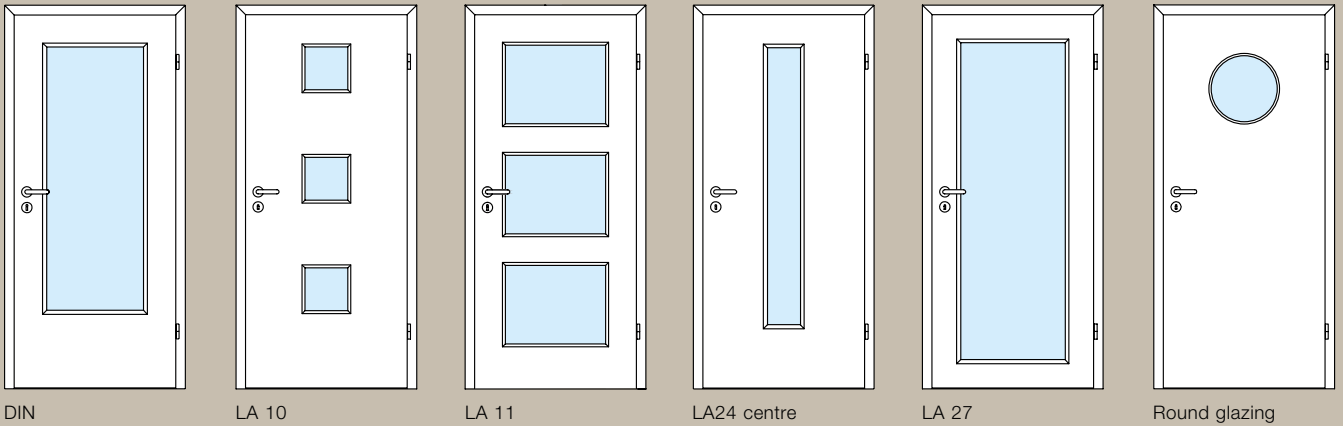

All door styles in the DesignLine Georgia, Vermont and Carolina ranges are available with glazing in the upper panels.

Side elements

(intel-high)

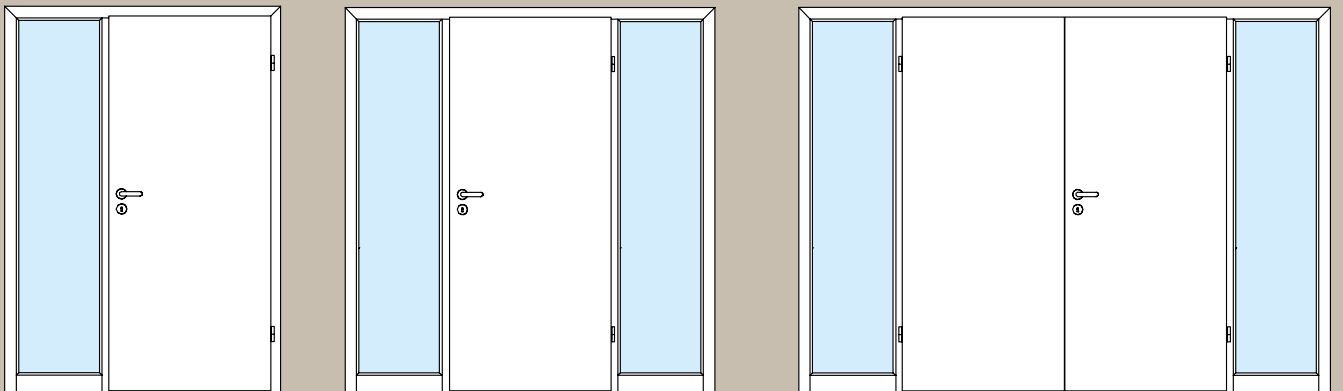

Single-leaf, 1 side element

Single-leaf, 2 side elements

Double-leaf, 2 side elements

Transom lights

(ceiling-high)

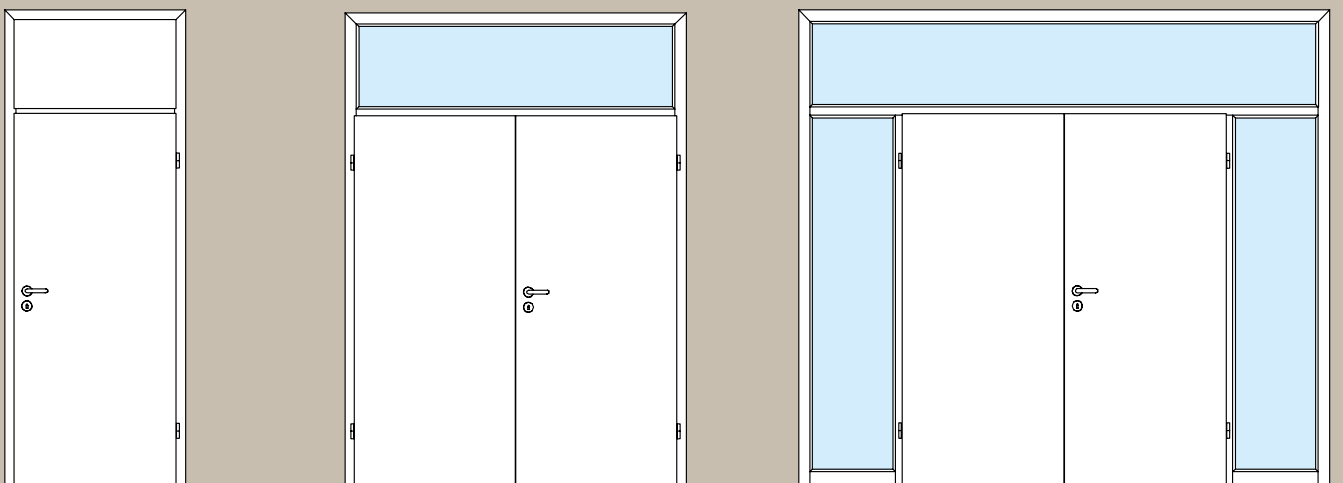

Single-leaf, 1 transom panel,
alternatively also with transom
light

Double-leaf, 1 transom light

Double-leaf, 2 side elements, 1 transom light

Individual wishes within reach

We are only satisfied when you have found your dream door, where every detail is right. For this reason, you can choose your handles and fittings individually from a wide-ranging Hörmann programme: The range of **lever handle sets for timber doors** can be found in our programme optionally as a flush-fitting **Planar version**, for the most elegant view. For design fans, we recommend lever handles and fittings **in the new black.edition**.

Special fittings for **all-glass doors** and **sliding doors** round off the extensive range.



For an especially elegant door appearance, all lever handles are optionally available in a flush-fitting Planar variant, as well as without drilled keyhole.

Lever handle sets for timber doors



Ala round rose escutcheon, matt stainless steel



Apart round rose escutcheon, matt stainless steel



Arundo round rose escutcheon, matt stainless steel



Basica 2 round rose escutcheon, matt stainless steel



Basica 3 round rose escutcheon, matt stainless steel



Contra round rose escutcheon, matt stainless steel



Dee round rose escutcheon, matt stainless steel

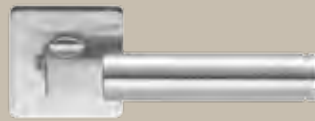

Dee square rose escutcheon, matt stainless steel



Graphica angular rose escutcheon, polished stainless steel



Graphica square flat rose escutcheon, matt stainless steel



Indra round rose escutcheon, matt polished stainless steel



Indra round flat rose escutcheon, matt stainless steel



Karee square rose escutcheon, matt stainless steel



Lilet round rose escutcheon, polished stainless steel, white porcelain handle



Linea round rose escutcheon, matt stainless steel

LEVER HANDLES AND FITTINGS

Lever handle sets for timber doors



Linea round flat rose escutcheon, matt stainless steel



Linea round flat rose escutcheon, polished stainless steel



Linea black.edition, round rose escutcheon, matt black ■ NEW



Linea square flat rose escutcheon, matt stainless steel



Luba round rose escutcheon, matt stainless steel



Linea black.edition, flat rose escutcheon, matt black ■ NEW



Quadrige square rose escutcheon, matt stainless steel



Selecta round rose escutcheon, matt polished stainless steel



Karee black.edition, square rose escutcheon, matt black ■ NEW



Senso round rose escutcheon, matt stainless steel



Tento round rose escutcheon, matt stainless steel



Karee black.edition, flat rose escutcheon, matt black ■ NEW



Vallis round rose escutcheon, matt stainless steel



Vento round rose escutcheon, matt stainless steel

Fittings for all-glass doors



Fitting set Aronda Combi, matt stainless steel, polished stainless steel or EV1



Fitting set Purista Combi, matt stainless steel, polished stainless steel or EV1



Fitting set Conica Combi, matt stainless steel or EV1



Fitting set Mina Combi, matt stainless steel



Fitting set Purista Combi, black.edition, matt black ■ **NEW**



Apart, matt stainless steel or polished / matt stainless steel



Basica 3, matt stainless steel or EV1



Belis, matt stainless steel



Dee, matt stainless steel, polished stainless steel or EV1



Grafica, matt stainless steel or polished stainless steel



Nala, matt stainless steel or polished stainless steel



Quadriga matt stainless steel



Linea, matt stainless steel, polished stainless steel or EV 1



Linea, black.edition, matt black ■ **NEW**



Karee, black.edition, matt black ■ **NEW**

Black is on trend!



Dark colours with black accentuation are becoming increasingly popular. Hörmann now offers a range of fittings in the new black.edition for timber and all-glass doors, producing a very attractive contrast on lighter surfaces!

Elegant all-glass door fitting



This innovation for all-glass doors can be used with timber and with steel frames. The reduced view of the fitting profile makes a very elegant impression. Practical: lever actuation is not necessary to open the door.

LEVER HANDLES AND FITTINGS

Recessed lever handles for sliding doors

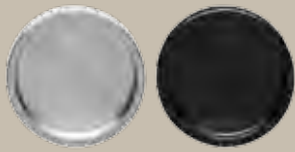

Recessed lever handle 6402 for timber doors, round, matt stainless steel or black.edition



Design recessed lever handle 3649 for timber doors, oval, matt stainless steel



Design recessed lever handle 3648 for timber doors, angular, matt stainless steel



Recessed lever handle FSB 4212, oval, matt stainless steel or aluminium



Recessed lever handle FSB 4250, fastenings for pushing in, matt stainless steel (for timber doors)



Recessed lever handle FSB 4251, angular, fastenings for pushing in, matt stainless steel



Recessed lever handle FSB 4252, round, fastenings for pushing in, matt stainless steel



Recessed lever handle FSB 4253, square, fastenings for pushing in, matt stainless steel



Recessed lever handle Norma 3657, oval, matt stainless steel



Recessed lever handle Rondell 3659, round, matt nickel

Handle bars for sliding doors



Handle bar pair Basic, round, matt stainless steel



Handle bar pair U-grip, round, matt stainless steel



Handle bar combination Combi, flat handle



Pair of handle bars, Basic, angular, matt stainless steel

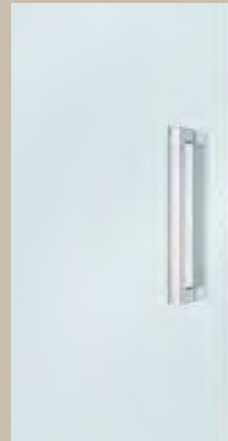

Handle bar pair U-grip, angular, matt stainless steel



Handle plate, black.edition
■ NEW
 Similar to stainless steel (bottom image)



For sliding doors that run within the wall, you can use a trip handle to release a door leaf completely concealed in the wall and close the door at the push of a button.



The handle plate can be used to fully open the sliding door running in front of the wall.

Fittings for flush-closing door leaves



Deadlock, Class I, lock cover in nickel silver (as standard)



Magnetic latch lock to gently and quietly close the door (optional)



3-part guide roller V 7888 WF 3D (optional, only for timber frame)



Concealed 3D hinge DX 61 (optional)



Concealed Euro hinge (optional) ■ **NEW**

Fittings for rebated door leaves

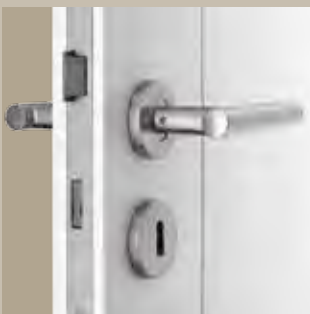

Deadlock, Class I, lock cover in nickel silver (as standard)

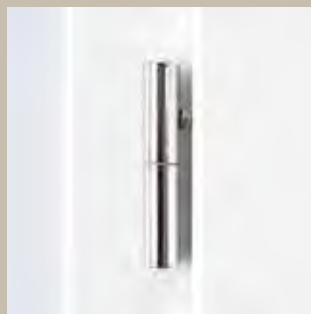

2-part hinge V 3420 WF (standard)

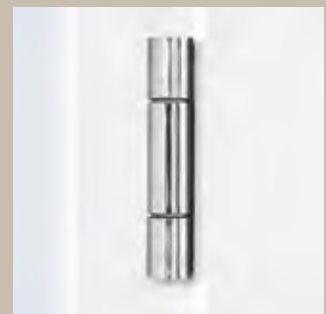

3-way adjustable hinge VX 160-18 (optional)



3-part hinge V 4426 WF (optional)



Concealed hinge Pivota FX 2 60 3D (optional)

High-quality surfaces, a variety of colours, natural decors you will love day after day



Duradecor smooth

- 48 % more impact-resistant than the average of the tested CPL surfaces from other manufacturers
- Hygienic and easy-care
- Strong anti-static and colour-fast properties
- Resistant to heat and abrasion
- Stands up to normal household fluids, pastes, etc.



White lacquer
RAL 9016



White Parchment



White Ash



Light grey
RAL 7035



Light Grey
Parchment

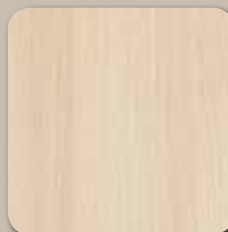

Italian Acacia



Canadian Maple



French Beech



4Protect edge protector

- High impact resistance
- High wear resistance
- High scratch resistance
- Perfect joint-free look, i.e. no visible joints, to satisfy the highest aesthetic demands.



Duradecor texture

- Characteristic timber texture with embossed wood grain
- 48 % more impact-resistant than the average of the tested CPL surfaces from other manufacturers
- Hygienic and easy-care
- Strong anti-static and colour-fast properties
- Resistant to heat and abrasion
- Stands up to normal household fluids, pastes, etc.



Grey Oak



Grey Oak
(Transverse)



White Oak



White Oak
(Transverse)

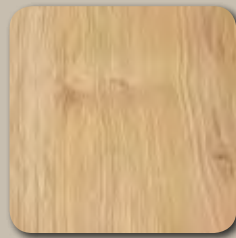

Wild Oak



Wild Oak
(Transverse)

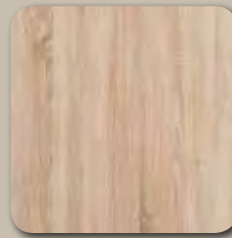

Raw Oak



Raw Oak
(Transverse)



Dark Oak



Spanish Oak



Spanish Oak
(Transverse)



Walnut



Brushed Salted Oak



Brushed Pine



Brushed White

■ NEW



4Protect edge protector

- High impact resistance
- High wear resistance
- High scratch resistance
- Perfect joint-free look, i.e. no visible joints, to satisfy the highest aesthetic demands

Ultra matt

- Velvety feel
- Duradecor surface finish with maximum impact resistance
- Anti-fingerprint to minimise fingerprints and soiling
- Can be coloured with chalk



Ultra matt
Traffic white



Ultra matt
Light grey



Ultra matt
Anthracite grey



Ultra matt
Taupe ■ NEW

Gloss

- High-gloss
- Extremely smooth surface finish
- Highly durable



Gloss
Traffic white



Gloss
Light grey



Gloss
Anthracite grey



Gloss
Taupe ■ NEW

Slate

- With raised texture
- Contrast of matt and gloss
- Highly durable



Slate
Traffic white



Slate
Light grey



Slate
Anthracite grey



Slate
Taupe ■ NEW

Linen ■ NEW

- Fine texture with natural appearance
- Duradecor surface finish with maximum impact resistance

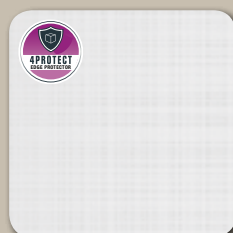

Linen
Traffic white



Linen
Light grey

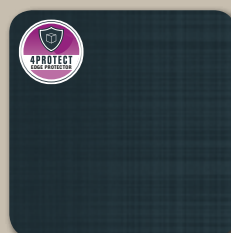

Linen
Anthracite grey



Linen
Taupe ■ NEW



Lacquer

- Smooth surface
- Rich, vibrant colour
- Paint coating on a white Duradecor base plate
- On request in RAL to choose



Traffic white
RAL 9016

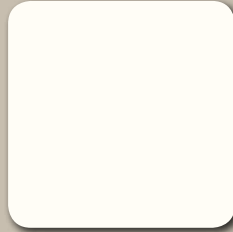

Pure white
RAL 9010



Light grey
RAL 7035

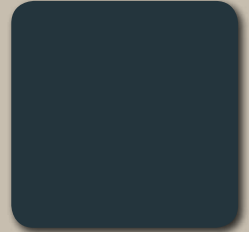

Anthracite grey
RAL 7016

Real wood veneer

- Made of high-quality real timber
- Environmentally friendly protective paint for durable surface protection
- Natural wood grain
- Long-lasting quality



Maple



Maple horizontal
■ NEW



Beech



Beech horizontal
■ NEW



Ash
■ NEW



Limba
■ NEW



Paintable Limba
■ NEW



Mountain Oak
■ NEW



American Oak
■ NEW



American Oak horizontal
■ NEW



Knotted Oak
■ NEW



Knotted Oak horizontal
■ NEW



Matt lacquer Alpine Oak
■ NEW

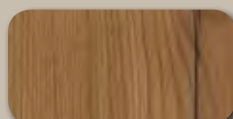

Oiled Oak in stressed timber
■ NEW



American Walnut
■ NEW



American Walnut horizontal
■ NEW



Stained Oak
■ NEW



Macore
■ NEW



Mahogany
■ NEW

Premium carpenter quality for high demands

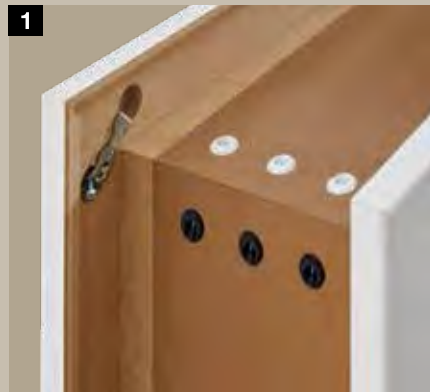

1 Attractive appearance with precision fit and installation-friendly corner joints

Lining board

- Screwed corner joints with lining board connection
- Easily readjustable
- Strong friction locking

Cladding

- Solid-metal screw connectors
- Excellent friction locking
- Direct pressure distribution on the connection surfaces
- No visible drilled holes in the cladding

2 High form stability thanks to the robust frame design

- Lining board 25 mm thick
- Lining board with Duradecor surface finish
- Melamine-coated backing
- Claddings made of MDF

3 Permanently quiet closing thanks to a high-quality seal

- Two-chamber system
- Clean contact to the door leaf
- Good absorbing properties

4 Robust standard lock plate for added security

- Movable back lining
- Secured with six screws
- Double-turn locking
- Conversion sets available

1

2

3

4

7

8





5 Hybrid hinge pocket prevents lowering of the door

- Carrying capacity 80 kg
- Reinforced metal plastic mount ■ **NEW**
- Four-point screw fixing in lining board
- Guiding sleeves extending to front edge of cladding
- For timber and all-glass doors



6 High stability thanks to door leaf with frame reinforcement

- Internal doors with 80 mm frame reinforcement
- On hinge side and lock side



7 Attractive round edge due to high-quality base materials



8 Robust angular edges thanks to 4Protect edge protector



- High impact resistance
- High wear resistance
- High scratch resistance
- Perfect joint-free look, meaning that unlike conventional doors, no visible joints **9** disturb the high-quality appearance of the door
- As standard for rebated doors with angular edges or flush-closing doors with Duradecor White lacquer, Light grey and Anthracite surface finishes



10 Modern colour

- In standard colour White lacquer RAL 9016























Strong Duradecor surface finish

- Extremely resistant to impact and scratching
- Colour-fast, heat-resistant



OVERVIEW TABLE

Door styles

	BaseLine	Design-Line Concepto	Design-Line Stripe	Design-Line Groove	Design-Line Steel	Design-Line Plain	Design-Line Rail	Design-Line Pure	Classic-Line Georgia	Classic-Line Carolina	Classic-Line Montana	Classic-Line Kontura	Classic-Line Virginia
Surface finishes													
Duradecor													
Rebated angular		●	–	○	–	●	●	●	●	●	–	–	–
Rebated round		●	–	–	–	●	●	●	●	●	–	–	●
Flush angular		●	–	○	–	●	●	●	●	●	–	–	–
Duradecor texture													
Rebated angular		●	–	–	–	●	●	●	●	○	–	–	–
Rebated round		●	–	–	–	●	●	●	●	○	–	–	–
Flush angular		●	–	–	–	●	●	●	●	○	–	–	–
Real wood veneer													
Rebated angular		●	–	–	–	–	–	●	–	○	–	–	–
Rebated round		○	–	–	–	–	–	○	–	○	–	–	–
Flush angular		●	–	–	–	–	–	●	–	○	–	–	–
Lacquer													
Rebated angular		●	–	–	●	●	●	●	●	●	–	–	–
Rebated round		●	–	–	●	●	●	●	●	●	○	○	○
Flush angular		●	–	–	●	●	●	●	●	●	–	–	–
Ultra matt													
Rebated angular		–	●	–	–	●	–	–	–	–	–	–	–
Rebated round		–	●	–	–	●	–	–	–	–	–	–	–
Flush angular		–	●	–	–	●	–	–	–	–	–	–	–
Gloss													
Rebated angular		–	●	–	–	–	–	–	–	–	–	–	–
Flush angular		–	●	–	–	–	–	–	–	–	–	–	–
Slate													
Rebated angular		–	●	–	–	–	–	–	–	–	–	–	–
Flush angular		–	●	–	–	–	–	–	–	–	–	–	–
Linen													
Rebated angular		–	●	–	–	–	–	–	–	–	–	–	–
Rebated round		–	●	–	–	●	–	–	–	–	–	–	–
Flush angular		–	●	–	–	–	–	–	–	–	–	–	–

● = available for all decors / colours

○ = not available for all decors / colours

Door inlay

Honeycomb insert	Tubular chipboard spacers	Tubular chipboard plate	Solid chipboard
•	-	•	•
-	•	•	•
-	-	•	•
•	-	•	•
-	•	•	•
-	-	•	•
-	•	•	•
-	○	○	○
-	•	•	•
-	-	•	•
-	•	•	•
-	•	•	•
-	-	•	•
-	-	•	•
-	-	•	•
-	-	•	•
-	-	•	•
-	-	•	•
-	-	•	•
-	-	•	•
-	-	•	•



Honeycomb insert
The honeycomb insert retains its shape and has an excellent price-performance ratio.



Tubular chipboard spacers
The door inlay consists of individual spacers that are arranged in the best possible layout. This means the door leaf is especially sturdy and suitable for heavy wear.



Tubular chipboard plate
The solid plate with horizontal tubes gives door leaves high surface stability. These high-quality internal doors are suitable for even heavier wear.



Solid chipboard
The high-quality solid chipboard door leaves have the highest leaf rigidity and are suitable for especially heavy wear. Doors with glazing cut-outs are available with solid chipboard as standard.

Frame types



Profile frame with rounded edges



Profile frame with angular edges (only for lacquer surface)



Profile frame with profile for ClassicLine Georgia and Carolina



Block frame

Door leaf

- Approx. 40 mm thick
- Frame construction made of solid timber / timber material with additional frame reinforcement, can be shortened by 25 mm at bottom
- For double-leaf doors: with counter rebate*
- Climatic class I Duty category N to S (according to version)
- Ready-to-hang acc. to DIN 18101
- Suited for timber profile frames or standard frames made of steel

Frame

- Rebate cladding 16 x 60 mm, mitred and firmly glued to the jamb lining. 16 x 80 mm on request
- Jamb lining made of 25 mm chipboard, rebate cladding and decorative edge made of 12 MDF boards
- Decorative edge 16 x 60 mm, optionally 16 x 80 mm
- Adjustable for wall thickness - 5 mm / + 15 mm
- Sound-absorbing seal inserted at the factory, mitred

Vertical view

Rebated

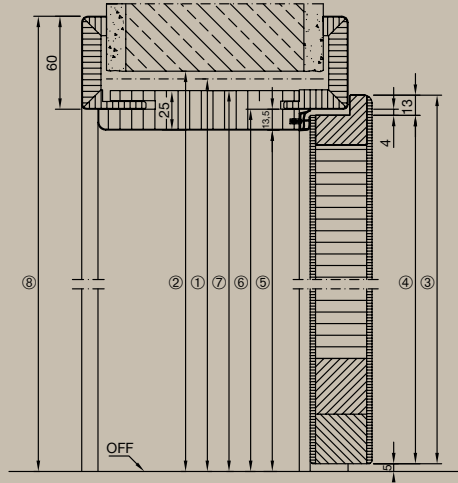

Flush

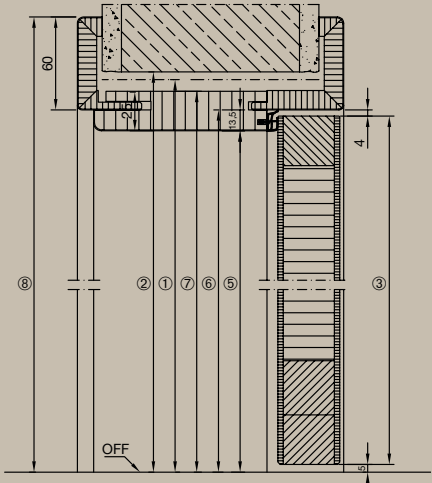

		1875	2000	2125	2250	
1	Nominal size height	1875	2000	2125	2250	
2	Wall opening	1880	2005	2130	2255	
3	Overall door leaf dimension	Rebated	1860	1985	2110	2235
		Flush	1847	1972	2097	2222
4	Leaf rebate dimension	1847	1972	2097	2222	
5	Clear passage dimension	1843	1968	2093	2218	
6	Frame hold dimension	1856	1981	2106	2231	
7	Overall lining dimension	1868	1993	2118	2243	
8	Overall frame dimension for 60 mm cladding (for 80 mm cladding + 20 mm)	1916	2041	2166	2291	

Frame types

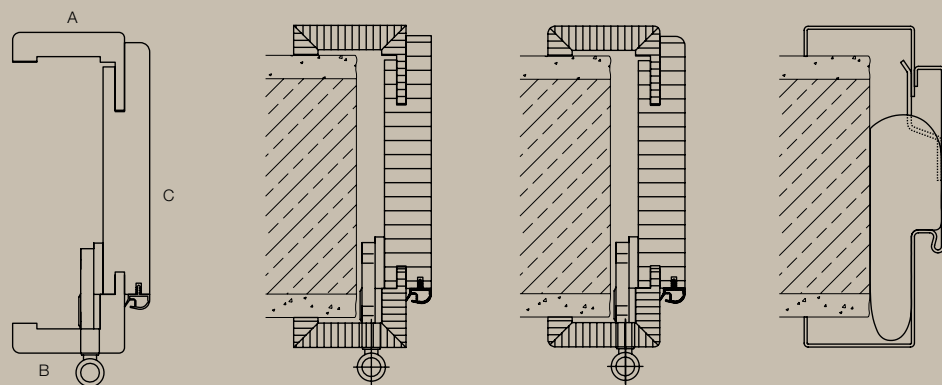

A: Decorative edge Timber frame, angular Timber frame, round edge Steel profile frame VarioFix
 B: Rebate cladding
 C: Jamb lining

Horizontal view – single-leaf

Rebated

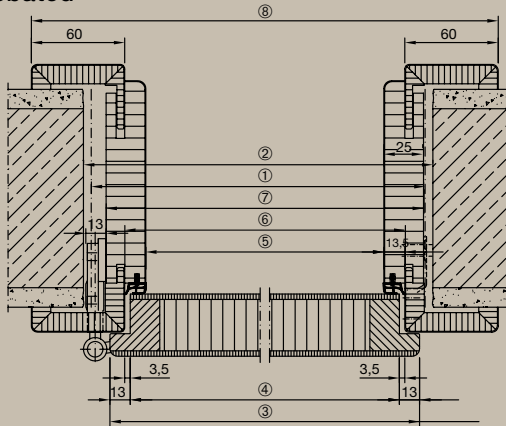

Flush

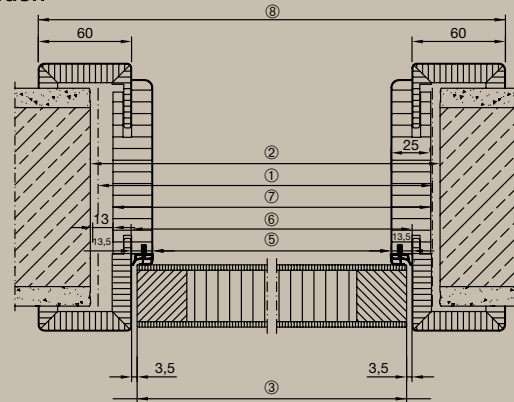

		625	750	875	1000	1125	1250
1 Nominal size width		625	750	875	1000	1125	1250
2 Wall opening		635	760	885	1010	1135	1260
3 Overall door leaf dimension	Rebated	610	735	860	985	1110	1235
	Flush	584	709	834	959	1084	1209
4 Leaf rebate dimension		584	709	834	959	1084	1209
5 Clear passage dimension		564	689	814	939	1064	1189
6 Frame hold dimension		591	716	841	966	1091	1216
7 Overall lining dimension		614	739	864	989	1114	1239
8 Overall frame dimension		711	836	961	1086	1211	1336

Horizontal view – double-leaf

Rebated

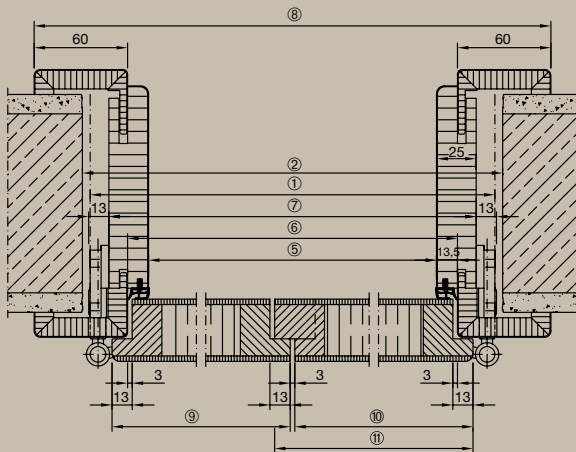

Flush

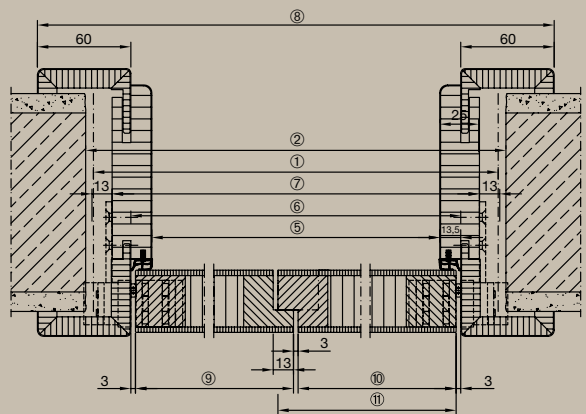

		1250	1375	1500	1750	1875	2000	2250	2500
1 Nominal size width		1250	1375	1500	1750	1875	2000	2250	2500
2 Wall opening		1260	1385	1510	1760	1885	2010	2260	2510
5 Clear passage dimension		1176	1301	1426	1676	1801	1926	2176	2426
6 Frame hold dimension		1203	1328	1453	1703	1828	1953	2203	2453
7 Overall lining dimension		1226	1351	1476	1726	1851	1976	2226	2476
8 Overall frame dimension		1323	1448	1573	1823	1948	2073	2323	2573
9 Overall door leaf dimension	Rebated	610	735	735	860	985	985	1110	1235
	Flush	597	722	722	847	972	972	1097	1222
10 Overall door leaf dimension	Rebated	610	610	735	860	860	985	1110	1235
	Flush	597	597	722	847	847	972	1097	1222
11 Overall door leaf dimension	Rebated	623	623	748	873	873	998	1123	1248
	Flush	610	610	735	860	860	985	1110	1235

* Only for Carolina door styles

All dimensions in mm



Experience Hörmann quality in new construction and modernisation

Hörmann provides an excellent basis for comprehensive planning. Carefully matched solutions offer you the very best in perfectly designed products for every area.

- **Garage doors**

Optimally match your personal architectural style: up-and-over or sectional doors made of steel or timber.

- **Door operators**

Enjoy extra convenience and break-in-resistant security with Hörmann operators for garage doors and entrance gates. You can profit from the convenience of Hörmann door operators in your residential space as well.

- **Entrance doors**

Our comprehensive entrance door ranges include models that fit almost every need and requirement.

- **Internal Doors**

Our high-quality timber internal doors and all-glass doors give your home an extra level of comfort and are harmoniously integrated into the overall appearance of your home.

- **Steel doors**

Sturdy doors for your entire home, from basement to roof.

- **Frames**

Choose from our comprehensive range of products for new construction, expansion and modernisation.



Garage doors and entrance gate operators

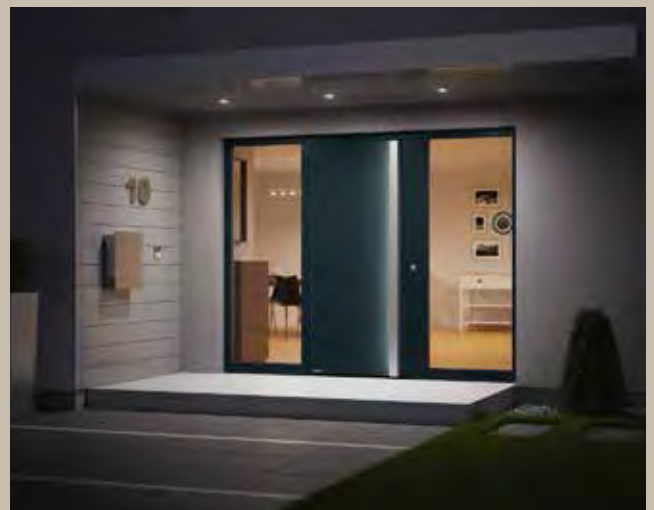

Entrance doors



Steel doors

Hörmann: Quality without Compromise



Hörmann KG Amshausen, Germany



Hörmann KG Antriebstechnik, Germany



Hörmann KG Brandis, Germany



Hörmann KG Brockhagen, Germany



Hörmann KG Dissen, Germany



Hörmann KG Eckelhausen, Germany



Hörmann KG Freisen, Germany



Hörmann KG Ichtershausen, Germany



Hörmann KG Werne, Germany



Hörmann Alkmaar B.V., Netherlands



Hörmann Legnica Sp. z o.o., Poland



Hörmann Beijing, China



Hörmann Tianjin, China



Hörmann LLC, Montgomery IL, USA



Hörmann Flexon LLC, Burgettstown PA, USA



Shakti Hörmann Pvt. Ltd., India

Hörmann is the only manufacturer worldwide that offers you a complete range of all major building products from one source. We manufacture in highly-specialised factories using the latest production technologies. The close-meshed network of sales and service companies throughout Europe, and activities in the USA and Asia, make Hörmann your strong partner for first-class building products, offering “Quality without Compromise”.

GARAGE DOORS
OPERATORS
INDUSTRIAL DOORS
LOADING EQUIPMENT
HINGED DOORS
DOOR FRAMES

HÖRMANN