



## Door systems for collective garages

Non-protruding up-and-over doors ET 500, sliding doors ST 500, underground garage rolling shutters and rolling grilles TGT, industrial sectional doors, speed sectional doors, up-and-over doors N 80 / N 500

**HÖRMANN**







- 4 Hörmann brand quality
- 6 Sustainably produced
- 8 Door systems for collective garages
- 10 Collective garage doors ET 500 and ST 500
- 12 Underground garage rolling shutter / rolling grille TGT
- 14 Industrial sectional doors
- 15 High-speed sectional doors
- 16 Up-and-over doors N 80 / N 500
- 18 Operator SupraMatic HT
- 19 Shaft operator  
WA 300 S4 / WA 300 R S4 / WA 300 AR S4
- 20 Chain drive operator ITO 400 FU
- 21 Shaft operator WA 400 FU
- 22 Accessories
- 28 Technical data
- 35 Programme overview

Some of the doors shown are equipped with optional extras and do not always correspond to our standard models.

The surface finishes and colours shown are subject to the limitations of the printing process and cannot be regarded as binding.

All rights reserved. No part may be reproduced without our prior permission. Subject to changes.



# Hörmann brand quality

Future-oriented and reliable



Kunst Campus, Berlin, with Hörmann products



## In-house product development

At Hörmann, innovation is produced in-house – highly qualified employees of the development departments are in charge of product optimisation and new developments. This results in market-ready, high-quality products that are very popular around the globe.



## Modern manufacturing

All of the essential door and operator components, such as sections, frames, fittings, operators and controls are developed and manufactured by Hörmann. This guarantees a high degree of compatibility between the door, operator and controls. Our certified quality management system ensures the highest quality, from development through to production and delivery.

**This is Hörmann quality – Made in Germany.**



As Europe's leading manufacturer of doors, hinged doors, frames and operators, we are committed to high product and service quality. This is how we set standards on an international scale.

Highly-specialised factories develop and manufacture construction components that are characterised by excellent quality, functional safety and a long service life.

Our presence in the global economy's key regions makes us a strong, future-oriented partner for industrial and public construction projects.



It goes without saying that spare parts for doors, operators and controls are original Hörmann parts that come with a guaranteed availability of 10 years.



### Competent advice

Experienced specialists within our customer-oriented sales organisation accompany you from the planning stage, through technical clarification up to the final building inspection. Complete working documentation, such as, e.g. technical manuals, is not only available in printed form, but also always accessible and up-to-date at [www.hoermann.com](http://www.hoermann.com).



### Fast service

Our extensive service network means that we are always nearby and at your service around the clock. This is a great advantage for testing, maintenance and repairs.



# Sustainably produced

## For future-oriented construction



### **Sustainability documented and approved by the ift in Rosenheim**

Hörmann has received confirmation of sustainability through an environmental product declaration (EPD) in accordance with ISO 14025 and EN 15804 from the Institut für Fenstertechnik (ift – Institute of window technology) in Rosenheim. The inspection was based on the Product Category Rules (PCR) “Doors and Gates”. Environmentally-friendly production was confirmed by a life-cycle analysis in accordance with DIN ISO 14040 / 14044.

### **Sustainably produced industrial sectional doors from Hörmann**

#### **Ecological quality**

Environmentally-friendly production through a comprehensive energy management system

#### **Economical quality**

A long service life and low maintenance costs thanks to the use of high-quality materials

#### **Process quality**

Sustainable production processes through optimised material use

### **Sustainable construction with Hörmann's expertise**

Hörmann has been able to gain great expertise in sustainable construction through various projects. We also apply this know-how to support your projects.

# Simple and sustainable planning

With the Hörmann Architects' Program and energy savings compass



## The Architects' Program

More than 9000 drawings for over 850 products

Planning with Hörmann products is now even easier thanks to a modern, user-friendly interface. Clearly structured navigation via drop-down menus and symbols, as well as a search function, provide faster access to texts for invitation of tenders and drawings (in DWG and PDF format) of over 850 Hörmann products. **In addition, BIM data can be provided for many products for the Building Information Modelling process, enabling efficient planning, drafting, construction and management of buildings.** Photos and photo-realistic presentations provide additional information on many products.



The Architects' Program is available to you as a web version at <https://www.hormann.co.uk/architects/architecture-consultation/architects-programme> or can be downloaded free-of-charge from the Hörmann Architects' Forum.

## The energy savings compass for sustainable planning

Hörmann's energy savings compass shows how industrial door systems and loading technology are planned with energy-efficiency and sustainability in mind. An integrated calculation module estimates the amortisation period for door and loading technology systems.

The energy savings compass is available as a web-based interface for PC / MAC and mobile end devices.



Plan with the energy savings compass at:  
[https://www.hormann.co.uk/fileadmin/\\_country/UK/Energiesparkompass/Energy\\_savings\\_compass/ml\\_eskSCALEframe.html](https://www.hormann.co.uk/fileadmin/_country/UK/Energiesparkompass/Energy_savings_compass/ml_eskSCALEframe.html)



We are a member of the professional association for digital building products in the Federal Association of Building Systems e.V.



# Door systems for collective garages

Hörmann quality doors and operators





## Continued increase in mobility

As the need for parking space in cities and urban centres continues to increase, underground and collective garages are becoming more and more important. These garages are often built in mixed-use residential and commercial areas. This requires door systems that are particularly quiet. Compliance with the acoustic rating requirements in accordance with DIN 4109 depends on the acoustic planning and design of the building structure.

## Quiet, dependable door travel

Hörmann collective garage door systems are equipped with soft start and soft stop as standard in SupraMatic HT, WA 300 S4 / WA 300 R S4 / WA 300 AR S4 and frequency-controlled FU operators, making them extremely quiet in all phases of opening and closing.

## Everything from a single source

Especially for this purpose, Hörmann offers perfectly matched systems consisting of door, operator and comprehensive accessory programme, which includes everything from key switch posts to warning light systems.

## Approved safety unit

With Hörmann door systems, you will benefit from the valuable experience of Europe's leading manufacturer. At Hörmann, the door and operator are always tested and certified as a unit.

## Which door, operator and control system best meets your requirements?

A suitable door, operator and control system is primarily designed by indicating the required cycle number per hour / day. Due to the different construction projects for collective garages (residential buildings, office buildings etc.), the required maximum cycle number must be indicated by the architect / planner during the planning stage.

The table below serves as a planning aid for selecting a suitable door system.

Please note that using a timer can significantly reduce door cycles during peak times in particular. With these additional accessories, a more cost-effective system may be available for your requirements. In addition, the service life of your door system increases, along with the cycle for wearing part replacement.

## Planning aid for collective garages

Door type	Operator	Parking spaces*	Max. door cycles** per		Max. clear passage in mm	
			Day	Hour	Width	Height***
Non-protruding up-and-over door ET 500	SupraMatic HT	Up to 100	300	20	6000	2965
	ITO 400 FU	Over 100	450	30		
Sliding door ST 500	SupraMatic HT	Up to 100	300	20	6000	3000
	ITO 400 FU	Over 100	450	30		
Underground garage rolling shutter TGT	WA 300 R S4 WA 300 AR S4	Up to 100	300	20	5000	2400
Underground garage rolling grille TGT	WA 300 R S4 WA 300 AR S4	Up to 100	300	20	6000	2400
Industrial sectional door	SupraMatic HT****	Up to 100	300	20	7000	3000
	WA 300 S4****	Up to 100	300	20	6000	
	ITO 400 FU	Over 100	450	30	8000	
	WA 400 FU	Over 100	450	30	8000	
High-speed sectional door HS 5015 PU N42	Direct drive operator	Over 100	450	50	5000	3000
Up-and-over door N 500	SupraMatic HT	Up to 25	75	10	4900	2620
Up-and-over door N 80	Optional	Up to 2	–	–	2860	2660

\* The parking spaces information relates to the assumption of 3 door cycles / parking space / day.

\*\* The information refers to the max. passage height. One door cycle consists of one Open / Close phase.

\*\*\* Greater door heights on request.

\*\*\*\* A technical inspection is required for maximum door sizes.

# Collective garage doors ET 500 and ST 500

Sturdy and dependable, with numerous design possibilities



Non-protruding up-and-over door ET 500



Sliding door ST 500



## Design possibilities

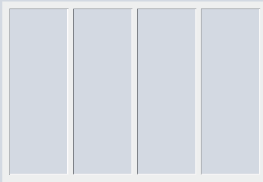

**Style 400**  
Frames for internal,  
on-site infill



**Style 402**  
Surface-mounted,  
ribbed sheet steel infill

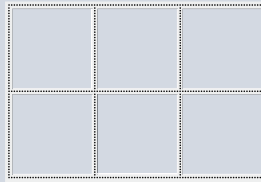

**Style 405**  
Frames for surface-mounted,  
on-site infill

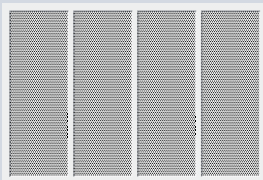

**Style 412 / 432**  
Internal, perforated sheet  
infill with round recesses

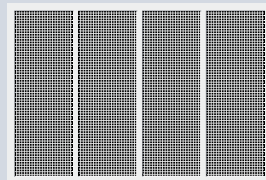

**Style 413 / 433**  
Internal, perforated sheet  
infill with square recesses

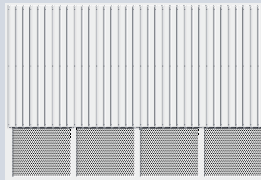

**Style 414**  
Surface-mounted, ribbed  
sheet steel with perforated  
sheet infill, round or square

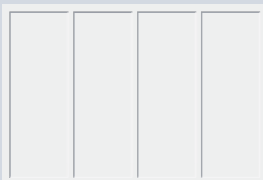

**Style 420**  
Internal, smooth aluminium  
sheet infill

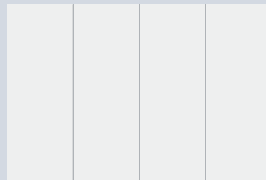

**Style 422**  
Surface-mounted,  
smooth aluminium sheet

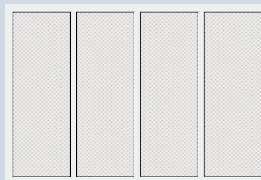

**Style 440**  
Internal expanded mesh infill

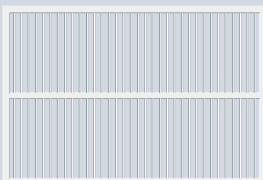

**Style 470**  
Infill with aluminium  
rods 20 x 20 x 2 mm

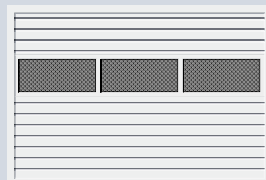

**Style 480**  
Infill with steel sections

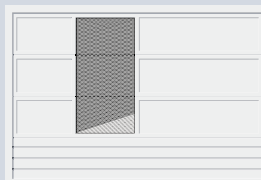

**Style 499**  
Combined infill, individually  
composed of other style  
variants (figure shows infill  
example)

## Non-protruding up-and-over door ET 500 Permanent functional safety with minimum swivelling range

The low-maintenance door construction with wear-free counter weight technology opens and closes smoothly, quietly and safely. Due to the limited frame depth, the space directly next to the door can also be used as a parking space.

## Sliding door ST 500 Low space requirements for optimised use of space

The collective garage sliding door ST 500 requires very little fitting depth. As a result, parking spaces can also be used directly next to the door. Thanks to the narrow subframe, it can also be fitted with very low headroom.

## Advantages at a glance

- Integrated photocell in the frame (fitted at the factory)
- Also available with wicket door
- Integrated in the facade due to on-site infill
- Side door with matching door style infill available
- Particularly smooth, quiet door travel and virtually silent opening and closing
- Approved unit of door and door operator for a long service life, minimum wear of the operator, high operational safety and low operating costs
- Door construction designed for at least 250000 door cycles



For more detailed information, please see the "Double and collective garage doors" brochure

# Underground garage rolling shutter / rolling grille TGT

The complete solution including operator



Underground garage rolling shutter TGT Decotherm S



Underground garage rolling grille TGT HG-L





1

Reliable tension spring technology



2

Operator WA 300 R S4 with curtain and operator cover

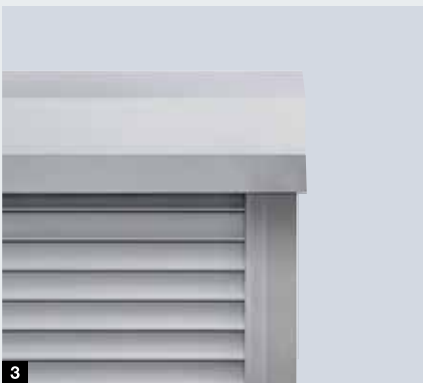

3

Integrated operator WA 300 AR S4 with curtain cover



4

Marten protection

## Curtain variants



Decotherm S, steel



HG-L, aluminium

Ventilation cross-section:  
approx. 73 % of the door surface

All curtains are supplied as standard with wind locks or pull-out protection.

## Robust and space-saving

Rolling shutters and rolling grilles are particularly robust thanks to their simple design. The compact barrel requires little space near the lintel. Exterior fitting is also possible if space is very tight.

## Advantages at a glance

- Smooth, quiet door travel
- Specially dimensioned tension spring assembly **1** for quiet door travel
- Service life of more than 200000 door cycles
- Optional curtain cover **3** prevents dangerous reaching into the barrel
- Low required headroom
- Smooth-running operator WA 300 R S4 **2** with optimal gear ratio
- Elegant operator solution with operator WA 300 AR S4 **3** integrated into the curtain cover
- Standard power limit in “Open” and “Close” directions provides maximum safety; neither closing edge safety device nor lintel trap guard required
- Emergency release for simple, quick manual opening of the door, use of entrances and exits ensured even during power failures
- Optional marten protection **4** for rolling grilles keeps small animals out
- Side door NT 60R with matching door style infill available
- Approved door and operator unit



For more detailed information on rolling shutter / rolling grille solutions up to 11750 mm width, please see the “Rolling shutters and rolling grilles” brochure

# Industrial sectional doors

Versatile and smooth-running



Industrial sectional door SPU F42 Plus

## Door types / infill variations



### SPU F42

PU-foamed sections, also available as SPU F42 Plus with all surface finishes of sectional garage doors with S-, M-, and L-ribbing



### SPU F42 / APU F42

Combination of PU-foamed sections and aluminium frames with infill



### ALR F42

Aluminium frame construction for large ventilation areas



### Expanded mesh

Stainless steel  
Ventilation cross-section: approx. 58 % of the infill surface



### Perforated steel sheet

Stainless steel  
Ventilation cross-section: approx. 40 % of the infill surface



### PU sandwich infill

Stucco-textured or smooth anodised

## Space-saving and easy to service

Sectional doors open vertically. This creates space both in front of and behind the door. With the frame fitted behind the opening, the clear passage of the garage opening can be used in full. This virtually eliminates the danger of damaging your car or the door. And, if damage does occur, sectional doors are very easy to repair. The individual door sections can be quickly and easily replaced. Doors and operators from Hörmann form an approved unit; optimally matched components subjected to endurance tests give you the assurance that your door will perform well in continued use.

## Advantages at a glance

- Ideal for tight spaces
- No swivelling out of the door leaf
- Low headroom track application with operator fitted directly to the door and no disruptive elements in the middle of the room
- Very easy to repair thanks to replaceable door sections
- Side door NT 60 with matching door style infill available
- Smooth, quiet door travel
- Approved unit of door and door operator for a long service life, minimum wear of the operator, high operational safety and low operating costs
- 200000 door cycles with specially dimensioned torsion springs



For more detailed information, please see the "Industrial sectional doors" brochure



# High-speed sectional doors

A combination of technology and design

*For especially  
fast door opening*



## Speed with a top design

The high-speed sectional door with its microprofiled surface enhances the door opening and is also very fast.

## Advantages at a glance

- Opening speeds of up to 1.5 m/s
- Elegant microprofiled surface
- No swivelling out of the door leaf
- Safety light grille integrated in the frame as standard
- Very easy to fit and service
- Smooth, quiet door travel
- Approved unit of door and door operator for a long service life, minimum wear of the operator, high operational safety and low operating costs
- Door construction designed for up to 1 million door cycles

High-speed sectional door HS 5015 PU N42

## Curtain variants



Aluminium frames with synthetic panes

The high-speed sectional door comes in RAL 9006 as standard and optionally in over 200 RAL colours.

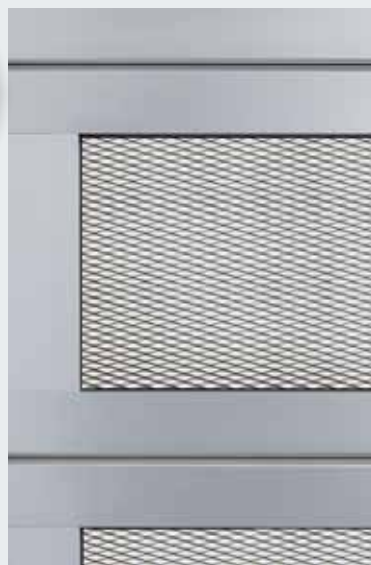

Aluminium frame with expanded mesh infill

Ventilation cross-section: approx. 54 % of the infill surface



For more detailed information, please see the "High-speed doors" brochure

# Up-and-over doors

Door solutions for entrances and individual parking spaces



Up-and-over door N 500



Up-and-over door N 80



## Design possibilities

### Up-and-over door N 500



**Style 400**  
Frames for internal, on-site infill



**Style 402**  
Surface-mounted, ribbed sheet steel infill

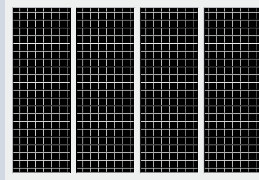

**Style 403**  
Internal welded grille infill

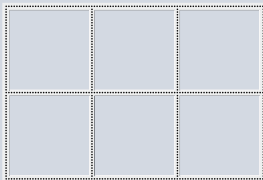

**Style 405**  
Frames for surface-mounted, on-site cladding

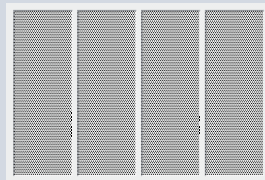

**Style 412**  
Internal, perforated sheet infill with round recesses

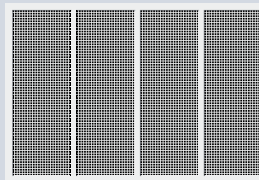

**Style 413**  
Internal, perforated sheet infill with square recesses



**Style 420**  
Internal, smooth aluminium sheet infill

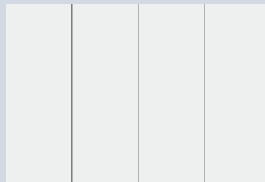

**Style 422**  
Surface-mounted, smooth aluminium sheet



**Style 440**  
Internal expanded mesh infill

### Up-and-over door N 80

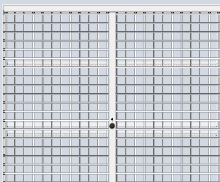

**Style 903**  
Welded grille (100 x 100 x 5 mm)

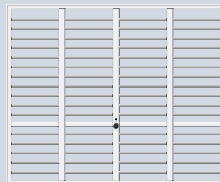

**Style 904**  
Round profiles (Ø 12 mm, spacing 100 mm)

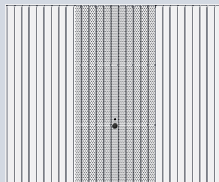

**Style 913**  
Ribbed steel with micro-perforation (Ø 4 mm)

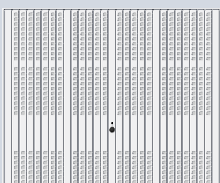

**Style 914**  
Ribbed steel with ventilation slots (50 x 50 mm)

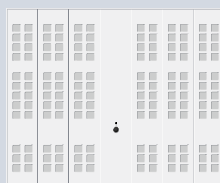

**Style 988**  
Steel panel with ventilation slots (90 x 90 mm)

## Up-and-over door N500: for collective garages with up to 25 parking spaces

The sturdy and open construction ensures precise and safe opening and closing. Thanks to the automatic operator locking, the door is secure.

### Advantages at a glance

- Operator package SupraMatic HT incl. photocell EL 301 and tension spring set for max. 100000 door cycles
- Integrated in the facade due to on-site infill
- Also available with wicket door
- Particularly smooth, quiet door travel and virtually silent opening and closing
- Approved unit of door and door operator for a long service life, minimum wear of the operator, high operational safety and low operating costs

## Up-and-over doors N 80: to reliably close off individual parking spaces

Up-and-over garage doors are ideally suited for reliably closing off parking spaces in collective garages, due to their sturdy construction and uncomplicated operation.

### Advantages at a glance

- Securely locked
- Optimum ventilation
- Sturdy construction
- Simple and reliable operation (optionally with an operator)

For more detailed information, please see the "Up-and-over garage doors" and "Double and collective garage doors" brochures



# Operator SupraMatic HT

Suitable for up to 100 parking spaces



## Door types and applications

### Non-protruding up-and-over door ET 500

Up to 100 parking spaces,  
**max. 300 door cycles\* per day**  
**Max. 20 door cycles\* per hour**  
 Max. door width 6000 mm  
 Max. door height 3000 mm

### Sliding door ST 500

Up to 100 parking spaces,  
**max. 300 door cycles\* per day**  
**Max. 20 door cycles\* per hour**  
 Max. door width 6000 mm  
 Max. door height 3000 mm

### Industrial sectional door

Up to 100 parking spaces,  
**max. 300 door cycles\* per day**  
**Max. 20 door cycles\* per hour**  
 Max. door width 7000 mm  
 Max. door height 3000 mm  
 For normal track application (N) and  
 low headroom track application (L)

### Up-and-over door N 500

Up to 25 parking spaces  
**Max. 75 door cycles\* per day**  
**Max. 10 door cycles\* per hour**  
 Max. door width 5000 mm  
 Max. door height 2750 mm

## Operator SupraMatic HT

With SupraMatic HT, Hörmann provides an operator system that is perfectly matched to collective garage doors. Suited to a maximum of 100 parking spaces, the operator is recommended for collective garages in tenement blocks, hotels and office buildings.

- **Soft start and soft stop for quiet and gentle door travel**
- Pull and push force 1000 N, brief peak force 1200 N
- Patented door locking in the operator boom with emergency release from inside
- With integrated control electronics including double 7-segment display for simple adjustment of operator functions directly on the operator
- Optional external control 360 for connecting traffic control, warning lights or additional prints

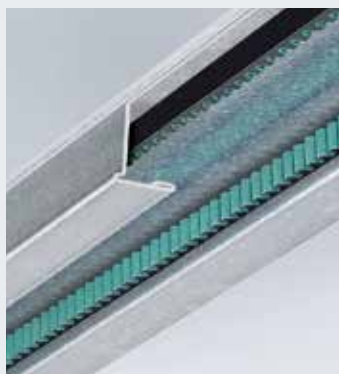

Quiet toothed belt technology



Optional 360 control

\* The information refers to the max. passage height. One door cycle consists of one Open / Close phase.



# Shaft operator WA 300 S4

## Shaft operator WA 300 R S4 / WA 300 AR S4

Suitable for up to 100 parking spaces



### Shaft operator WA 300 S4 / WA 300 R S4 / WA 300 AR S4

The inexpensive shaft operator is equally suited for doors in underground garages as well as in commercial areas.

- **Soft start and soft stop for gentle and quiet door travel**
- Power limit in "Open" / "Close" directions
- Integrated control with push button DTH R
- No installations or wiring required on the door (except for doors with wicket door)
- The maintenance release directly on the operator saves time for statutory annual inspection work
- Only approx. 1 watt power consumption in stand-by mode (if no other electrical accessories are connected)
- Optional external control 360 (prepared for traffic control)



**The compact operator WA 300 AR S4** for underground garage rolling shutters and rolling grilles TGT only requires 100 mm additional sideroom on the operator side.



**Optional emergency release**  
The door can be easily manually opened via an emergency release during a power failure. It is available in versions for inside (see figure) and outside (in a lockable diecast housing).

### Door types and applications

#### Industrial sectional door WA 300 S4

Up to 100 parking spaces,  
max. 300 door cycles\* per day  
Max. 20 door cycles\* per hour  
Max. door width 6000 mm  
Max. door height 3000 mm

#### Underground garage rolling shutter TGT WA 300 R S4 / WA 300 AR S4

Up to 100 parking spaces,  
max. 300 door cycles\* per day  
Max. 20 door cycles\* per hour  
Max. door width 5000 mm  
Max. door height 2400 mm

#### Underground garage rolling grille TGT WA 300 R S4 / WA 300 AR S4

Up to 100 parking spaces,  
max. 300 door cycles\* per day  
Max. 20 door cycles\* per hour  
Max. door width 6000 mm  
Max. door height 2400 mm

\* The information refers to the max. passage height. One door cycle consists of one Open / Close phase.

# Chain drive operator ITO 400 FU

For over 100 parking spaces

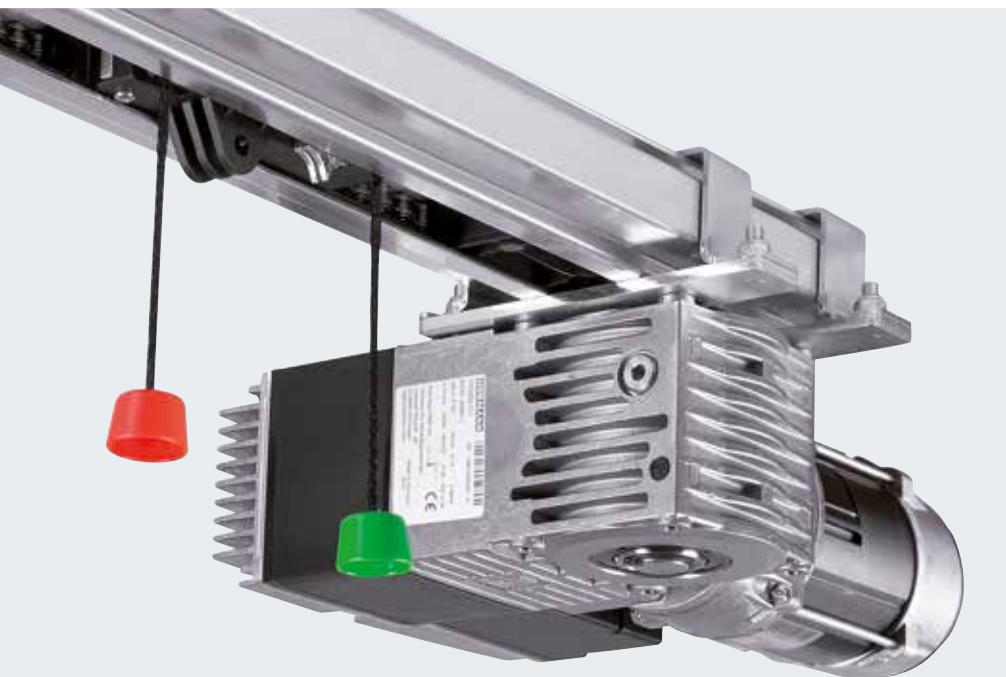

## Chain drive operator ITO 400 FU

The chain drive operator ITO 400 FU is particularly suited for doors in high-traffic underground and collective garages as well as in commercial areas.

- **Soft start and soft stop for quiet and gentle door travel**
- Emergency release via Bowden cable
- Jet-water protection for operator and control (IP 65)
- Settings on a separate control B 460 FU via a control panel
- Expandable through additional units (activating kits for warning lights, traffic control)

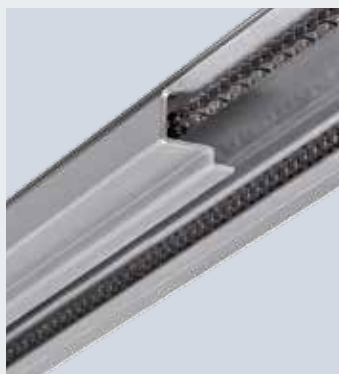

Robust operator boom and control chain designed for high loads.



The menu for control B 460 FU allows you to quickly set, for example, hold-open phases and visual indicators for warning lights.

## Door types and applications

**Non-protruding up-and-over door ET 500**

**Over 100 parking spaces,**  
**max. 450 door cycles\* per day**  
**Max. 30 door cycles\* per hour**  
Max. door width 6000 mm  
Max. door height 3000 mm

**Sliding door ST 500**

**Over 100 parking spaces,**  
**max. 450 door cycles\* per day**  
**Max. 30 door cycles\* per hour**  
Max. door width 6000 mm  
Max. door height 3000 mm

**Industrial sectional door**

**Over 100 parking spaces,**  
**max. 450 door cycles\* per day**  
**Max. 30 door cycles\* per hour**  
Max. door width 8000 mm  
Max. door height 3000 mm  
For normal track application (N) and  
low headroom track application (L)

\* The information refers to the max. passage height. One door cycle consists of one Open / Close phase.



# Shaft operator WA 400 FU

For over 100 parking spaces



## Door types and applications

### Industrial sectional door

Over 100 parking spaces,  
max. 450 door cycles\* per day  
Max. 30 door cycles\* per hour  
Max. door width 8000 mm  
Max. door height 3000 mm

## Shaft operator WA 400 FU

The powerful shaft operator is equally suited for doors in high-traffic underground and collective garages, as well as in commercial areas.

- **Soft start and soft stop for gentle and quiet door travel**
- Versions: to flange, with chain box and for central mounting
- Maintenance release as standard
- Optional fixed release for simple emergency release from the floor
- Control B 460 FU as standard
- Expandable through additional units (activating kits for warning lights, traffic control)



The maintenance release directly on the operator saves time for statutory annual inspection work and can be converted to a fixed release at any time.



The optional leading photocell provides maximum security according to DIN 12453.

\* The information refers to the max. passage height. One door cycle consists of one Open / Close phase.

# Accessories

## Radio control, receiver



### Hörmann BiSecur (BS)

#### The modern radio system for industrial door operators

The bi-directional radio system BiSecur is based on future-oriented technology for the convenient and secure operation of industrial doors. The extremely secure BiSecur encryption protocol makes sure that no-one can copy your radio signal. It was tested and certified by security experts at Bochum university.

#### Your advantages

- 128-bit encryption with the same high security level as online banking
- Interference-resistant radio signal with a stable range
- Convenient inquiry of the door position\*
- Backwards compatible, i.e. radio receivers with the frequency 868 MHz (2005 to June 2012) can also be operated with BiSecur control elements.



**5-button hand transmitter HS 5 BS**  
With additional button for querying the door position\*, high-gloss black or white, with chrome caps



**5-button hand transmitter HS 5 BS**  
With additional button for querying the door position\*, black textured surface, with chrome caps



**4-button hand transmitter HS 4 BS**  
Black textured surface with chrome caps



**1-button hand transmitter HS 1 BS**  
Black textured surface with chrome caps



**4-button security hand transmitter HSS 4 BS**  
Additional function: copy protection for hand transmitter coding, with chrome caps



**2-button hand transmitter HSE 2 BS**  
High-gloss black or white, with chrome caps



**4-button hand transmitter HSE 4 BS**  
Black textured surface with chrome or plastic caps



**1-button hand transmitter HSE 1 BS**  
Black textured surface with chrome caps



\* For SupraMatic HT and WA 300 S4 with optional bi-directional receiver ESEi BS, for all other operators with optional bi-directional receiver HET-E2 24 BS and end-of-travel position feedback.



**Industrial hand transmitter  
HSI 6 BS, HSI 15 BS**  
To control up to 6 doors  
(HSI 6 BS) or 15 doors  
(HSI 15 BS), with extra-large  
buttons for easier operation  
with work gloves,  
impact-resistant housing  
Protection category: IP 65



**Radio code switch  
FCT 3 BS**  
With illuminated buttons  
3 function codes



**Radio code switch  
FCT 10 BS**  
With illuminated buttons  
and protective cover,  
10 function codes



**Radio finger-scan  
FFL 12 BS**  
2 function codes and  
up to 12 fingerprints



**Industrial hand transmitter  
HSI BS**  
To control up to 1000 doors,  
with a display and extra-large  
quick selection buttons for easier  
operation with work gloves,  
transferring of hand transmitter  
coding to other devices possible



**1-channel relay receiver  
HER 1 BS**  
With volt-free relay output  
with status query



**2-channel relay receiver  
HER 2 BS**  
With 2 volt-free relay outputs with  
status query and external antenna



**2-channel relay receiver  
HET-E2 24 BS**  
With 2 volt-free relay outputs for  
choosing the direction, a 2-pin  
input for volt-free Open and Close  
limit switch reporting (for querying  
the door position)



**4-channel relay receiver  
HER 4 BS**  
With 4 volt-free relay outputs  
with status query



**3-channel receiver  
HEI 3 BS**  
For controlling 3 functions



**Bi-directional receiver  
ESEi BS**  
For querying the door position





# Accessories

## Push buttons



### Push button DTH R

For separate control of both operational directions, with separate stop button, protection category: IP 65, dimensions: 90 × 160 × 55 mm (W × H × D)

#### For controls:

**360, A / B 445, A / B 460, B 460 FU and integrated control WA 300 S4**



### Push button DTH RM

For separate control of both operational directions, with separate stop button, With miniature lock: operator control is deactivated. The operator can no longer be actuated (2 keys included in the scope of delivery).

Protection category: IP 65, dimensions: 90 × 160 × 55 mm (W × H × D)

#### For controls:

**360, A / B 445, A / B 460, B 460 FU and integrated control WA 300 S4**



### Push button DTH I

To move the door into the Open / Close positions, separate stop button to stop door travel, 1/2 Open button to open the door up to the programmed intermediate travel limit, protection category: IP 65, dimensions: 90 × 160 × 55 mm (W × H × D)

#### For controls:

**360, A / B 460, B 460 FU and integrated control WA 300 S4** (only in combination with UAP 1)



### Push button DTH IM

To move the door into the Open / Close positions, separate stop button to stop door travel, 1/2 Open button to open the door up to the programmed intermediate travel limit, with miniature lock: operator control is deactivated. The operator can no longer be actuated (2 keys included in the scope of delivery).

Protection category: IP 65, dimensions: 90 × 160 × 55 mm (W × H × D)

#### For controls:

**360, A / B 460, B 460 FU and integrated control WA 300 S4** (only in combination with UAP 1)



### Push button DT 02

Open or close via a command button, separate stop button, dimensions: 75 × 145 × 70 mm (W × H × D), protection category: IP 65

#### For controls:

**A / B 445, A / B 460 and B 460 FU**



### Push button DT 03

For separate control of both operational directions, with separate stop button, dimensions: 75 × 180 × 70 mm (W × H × D), protection category: IP 65

#### For controls:

**A / B 445, A / B 460 and B 460 FU**



### Push button DT 04

For separate control of both operational directions, with separate stop button, full or partial door opening (via separate button), dimensions: 75 × 225 × 70 mm (W × H × D), protection category: IP 65

#### For controls:

**A / B 460 and B 460 FU**



### Push button DTN A 30

For separate control of both operational directions. The stop button is a push-to-lock button which, once pressed, stays depressed in order to prevent unauthorised operation. Subsequent actuation is then only possible once the stop button has been unlocked with a key (2 keys included in the scope of delivery). Dimensions: 75 × 180 × 105 mm (W × H × D), protection category: IP 65

#### For controls:

**A / B 445, A / B 460 and B 460 FU**

# Accessories

## Push button, key switch, pull switch, key switch post



### Push button DTP 02

Open or close via a command button, separate stop button and operation control light for control voltage, lockable with profile half cylinder (available as an accessory), dimensions: 77 x 235 x 70 mm (W x H x D), protection category: IP 44

#### For controls:

A / B 445, A / B 460 and B 460 FU



### Push button DTP 03

For separate control of both operational directions, separate stop button and operation control light for control voltage, lockable with profile half cylinder (available as an accessory), dimensions: 77 x 270 x 70 mm (W x H x D), protection category: IP 44

#### For controls:

A / B 445, A / B 460 and B 460 FU



### Emergency-off button DTN 10

To quickly immobilise the door system, push-to-lock button (mushroom button), surface-mounted, dimensions: 93 x 93 x 95 mm (W x H x D), protection category: IP 65

#### For controls:

A / B 445, A / B 460 and B 460 FU



### Emergency-off button DTNG 10

To quickly immobilise the door system, push-to-lock mushroom button, surface-mounted, dimensions: 93 x 93 x 95 mm (W x H x D), protection category: IP 65

#### For controls:

A / B 445, A / B 460 and B 460 FU

The lockable function serves to isolate the control voltage and immobilises the command units. Profile half cylinders are not included in the scope of delivery for the push buttons.



### Key switch ESU 30 with 3 keys

Recessed version, Impulse or Open / Close functions selectable, dimensions of the switch box: 60 mm (d), 58 mm (D), dimensions of the cover: 90 x 100 mm (W x H), brickwork recess: 65 mm (d), 60 mm (D), protection category: IP 54

Surface-mounted version ESA 30

(not shown)

Dimensions:

73 x 73 x 50 mm (W x H x D)



### Key switch STUP 50 with 3 keys

Recessed version, dimensions: 80 x 80 mm (W x H), protection category: IP 54

### Key switch STAP 50 with 3 keys

Surface-mounted version (not shown) Dimensions: 80 x 80 x 63 mm (W x H x D)



### Pull switch ZT 2 with cord

Impulse transmission to open or close the door, dimensions: 60 x 90 x 55 mm (W x H x D), pull cord length: 3.2 m, protection category: IP 65

Cantilever arm KA1 (not shown)

Extension 1680 - 3080 mm, can be used with ZT 2

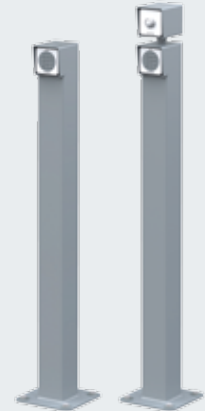

### Key switch posts

With a screw base for fitting to the floor, surface in White aluminium RAL 9006, 90 x 90 mm tube, also available as a set-in-concrete version

### Key switch post STN 1 // NEW

To hold 1 command unit on the surface, height 1050 mm

### Key switch post STN 1-1 // NEW

To hold 2 command units or 1 command unit and 1 warning light, height 1200 mm

#### For command units:

CTR 1b-1, CTR 3b-1, CTV 3-1, CTP 3-1, TTR 1000-1, FL 150, STUP 50, double LED warning lights red / green

# Accessories

## Code switches



**Code switch CTR 1b-1, CTR 3b-1**  
For 1 (CTR 1b-1) or 3 (CTR 3b-1) functions, with illuminated buttons

Dimensions:  
80 × 80 × 15 mm (W × H × D)



**Code switch CTV 3-1**  
For 3 functions, with particularly robust metal keypad

Dimensions:  
80 × 80 × 15 mm (W × H × D)



**Code switch CTP 3**  
For 3 functions, with illuminated lettering and touch-sensitive surface

Dimensions:  
80 × 80 × 15 mm (W × H × D)



**Decoder housing**  
For code switch CTR 1b-1, CTR 3b-1, CTV 3-1, CTP 3

Dimensions:  
140 × 130 × 50 mm (W × H × D),  
switching capacity: 2.5 A / 30 V DC  
500 W / 250 V AC



**Finger-scan FL 150**  
For 2 functions, up to 150 fingerprints can be saved, optional surface-mounted housing (not shown)

Dimensions:  
80 × 80 × 13 mm (W × H × D)



**Transponder key switch TTR 1000-1**  
For 1 function via transponder key or transponder card, up to 1000 keys or cards can be saved

Dimensions:  
80 × 80 × 15 mm (W × H × D),  
decoder housing:  
140 × 130 × 50 mm (W × H × D),  
switching capacity: 2.5 A / 30 V DC  
500 W / 250 V AC





# Accessories

## Activating kits, LED traffic lights



## Warning lights With bright and long-lasting LEDs



### Multi-function circuit board for fitting in an existing housing or optionally in a separate extension housing (shown)

Limit switch reporting, momentary impulse, collective malfunction signalling, extension unit for controls 360, A / B 445, A / B 460, B 460 FU

Dimensions of additional housing:  
202 × 164 × 130 mm (W × H × D),  
protection category: IP 65  
A circuit board can be optionally mounted in the control.



### Digital weekly timer in a separate additional housing

The timer can switch command units on and off via a volt-free contact. Extension unit for controls A / B 460, B 460 FU, 360 (no additional housing, for fitting in an existing housing), switching capacity: 230 V AC 2.5 A / 500 W, can be switched over to summer / winter time, manual switching: automatic operation, switching preselection "permanently ON / OFF"

Dimensions of additional housing:  
202 × 164 × 130 mm (W × H × D),  
protection category: IP 65



### Summer / winter activating kit in additional housing

Function for full door opening and individually programmable intermediate travel limit, extension unit for controls A / B 460, B 460 FU

Dimensions of additional housing:  
202 × 164 × 130 mm (W × H × D),  
protection category: IP 65



### Activating kit for warning lights for fitting in an existing housing or optionally in a separate extension housing (shown), incl. 2 yellow warning lights

Extension unit for controls 360, A / B 445, A / B 460, B 460 FU. The activating kit for warning lights serves as a visual indicator during door operation (weekly timer, optionally for 360, A / B 460, B 460 FU). Applications: approach warning (for 360, A / B 445, A / B 460, B 460 FU), automatic timer (for 360, A / B 460, B 460 FU). After the set hold-open phase has elapsed (0 – 480 s), the warning lights flash during the set pre-warning phase (0 – 70 s). Traffic light dimensions: 180 × 250 × 290 mm (W × H × D), dimensions of additional housing: 202 × 164 × 130 mm (W × H × D), contact load: 250 V AC: 2.5 A / 500 W, protection category: IP 65



### Traffic control in a separate additional housing (A / B 460, B 460 FU) or for fitting in an existing housing (360) incl. 2 red / green traffic lights

Extension unit for controls 360, A / B 460, B 460 FU. The activating kit for warning lights serves as a visual indicator for regulating the entrance and exit (optional weekly timer). Duration of the green phase: adjustable 0 – 480 s  
Duration of the clearance phase: adjustable 0 – 70 s  
Traffic light dimensions: 180 × 410 × 290 mm (W × H × D), dimensions of additional housing: 202 × 164 × 130 mm (W × H × D), contact load: 250 V AC: 2.5 A / 500 W, protection category: IP 65

# Technical data

## Non-protruding up-and-over door ET 500

### Vertical view

#### Fitting behind the opening

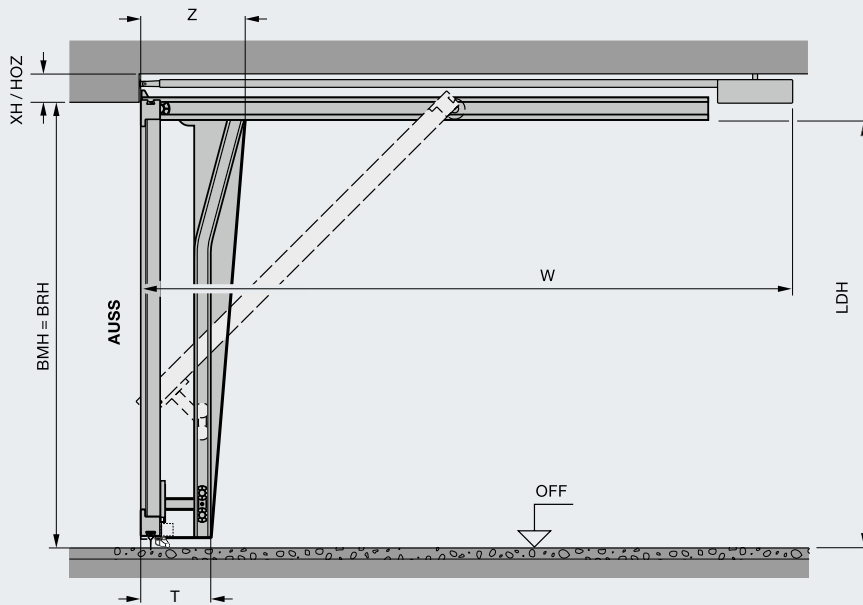

### Horizontal view

#### Fitting behind the opening

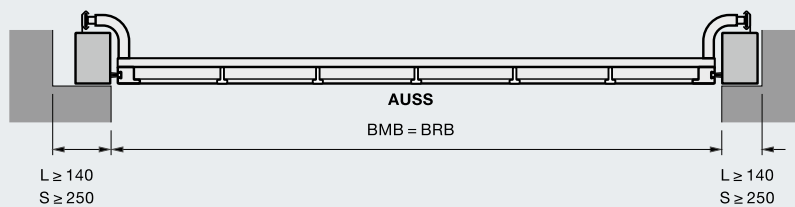

### Explanation of dimensions

HOZ	Transom light frame height
XH	Required headroom
LDH	Clear passage height
LDB	Clear passage width
BRH	Nominal size height (= ordering size)
BRB	Nominal size width (= ordering size)
BMB	Ordering size width
BMH	Ordering size height
Z / T	Frame depth
AUSS	Exterior
OFF	Finished floor level

### Overall length with operator W

SupraMatic HT	
BRH 2000 – 2250	3200
BRH 2255 – 2500	3450
BRH 2505 – 3000	4125

### ITO 400 FU

BRH 2000 – 2700	3840
BRH 2705 – 3000	4840

### Required headroom XH

SupraMatic HT	
Fitting behind the opening	100
With wicket door	100
With surface-mounted infill	y + 100
y = Thickness of surface-mounted infill	

### Height transom light frame HOZ (door with subframe)

SupraMatic HT	
Fitting in the opening	120
With wicket door	120
Infill overlapping	160

### ITO 400 FU

Fitting behind the opening	120
With wicket door	120
With surface-mounted infill	160

Fitting in the opening	160
With wicket door	160
With surface-mounted infill	160

### Clear passage height LDH

BRB < 4500	= BRH – 35
BRB ≥ 4500	= BRH – 75
With wicket door	= BRH – 85

### Flush-fitting installation

With subframe	
BRB ≤ 4495	= BRH + 25
BRB ≥ 4500	= BRH – 15
With wicket door	= BRH – 25

### Frame depth Z / T

ET 500 L	450 / 295
ET 500 S	400 / 245

### Note

For more detailed information, please see the technical manual or contact your Hörmann partner.

\* An optional subframe is available for fitting without lintel and / or sideroom.

# Technical data

## Sliding door ST 500

### Vertical view

Fitting behind the opening

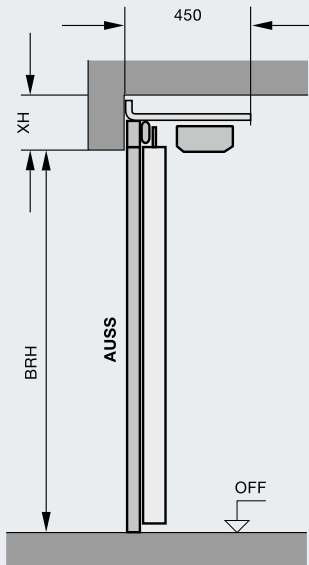

### Horizontal view

Fitting behind the opening

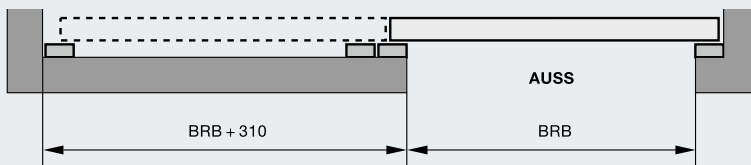

### Explanation of dimensions

XH	Required headroom
LH	Clear height
LB	Clear width
LDH	Clear passage height
LDB	Clear passage width
BRH	Nominal size height (= ordering size)
BRB	Nominal size width (= ordering size)

#### Required headroom XH

≥ 200

#### Nominal size height

**BRH = clear height LH**

BRH 2000 – 3000

#### Nominal size width

**BRB = clear width LB**

BRB 2250 – 6000

#### Clear passage height LDH

LDH = BRH

#### Clear passage width LDB

LDB = BRB – 50

(The clear passage may vary depending on the fitting situation)

#### Note

For more detailed information, please see the technical manual or contact your Hörmann partner.



# Technical data

## Rolling shutter / rolling grille TGT

### Vertical view

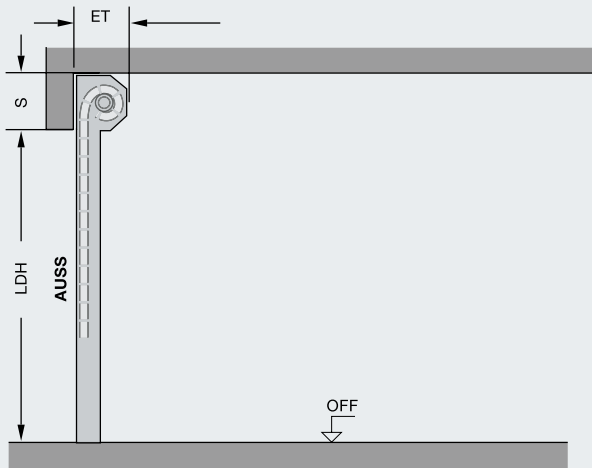

### Horizontal view

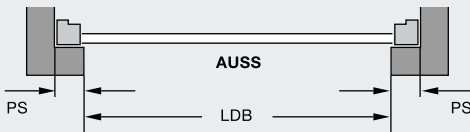

### Explanation of dimensions

LDB	Clear passage width
LDH	Clear passage height
ET	Fitting depth
S	Required headroom
PS	Side space requirements

**Clear passage width LDB** = door width (ordering size)

**Clear passage height LDH** = door height (ordering size)

#### Fitting depth ET

Decotherm	370
With PVTGT	440
HG-L	370
With PVTGT	440

#### Required headroom S for full passage height

##### Decotherm

Door height 2400	365
Door height 2250	360
Door height 2000	355
With PVTGT	380

##### HG-L

Door height 2400	335
Door height 2250	330
Door height 2000	325
With PVTGT	350

**Side space requirements PS** 165

All dimensions also apply to fitting as an external rolling shutter.

### Size range

Rolling shutter TGT	Max. width	5000
	Max. height	2400
Rolling grille TGT	Max. width	6000
	Max. height	2400

For additional sizes and equipment options, please see the product brochures and technical manual.

# Technical data

## Industrial sectional doors

### Vertical view

#### Sectional door with track application N

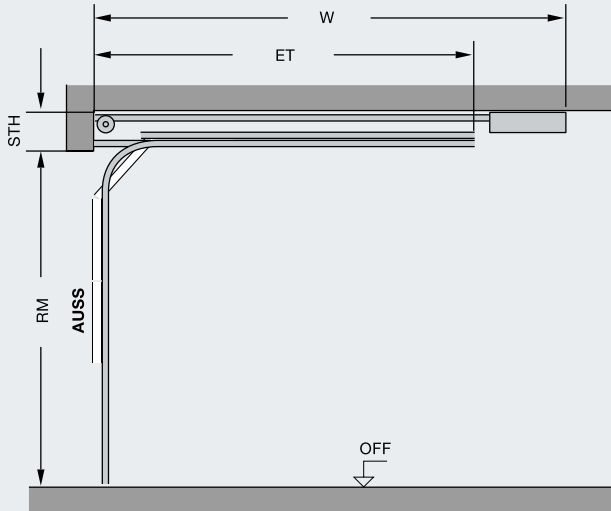

#### Sectional door with track application L

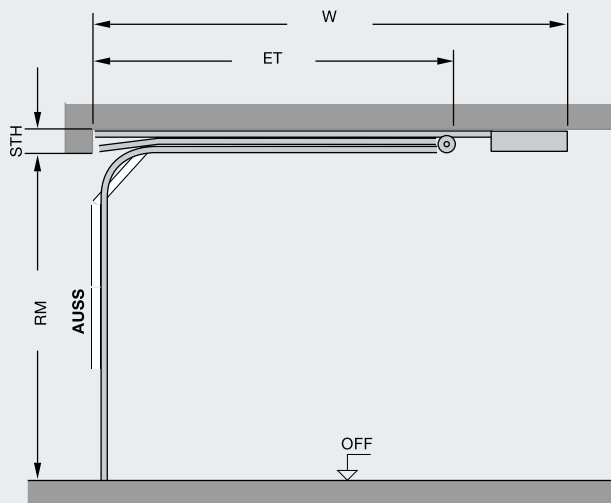

### Horizontal view

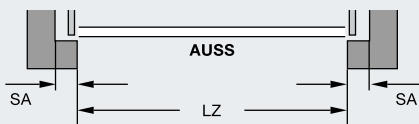

### Size range

Max. width	8000
Max. height	3000

Dimensions in mm

### Explanation of dimensions

LDB	Clear passage width
LDH	Clear passage height
ET	Distance back
W	Distance back with operator
STH	Headroom
SA	Sideroom
LZ	Clear frame dimensions (ordering size)
RM	Grid height (ordering size)

**Clear passage width LDB** = LZ

#### Clear passage height LDH

Track application N

LZ < 5500 = RM

LZ > 5500 = RM - 50

Track application L

LZ < 5500 = RM - 50

LZ > 5500 = RM - 100

#### Distance back with operator W

##### SupraMatic HT

Track application N

RM 3000 - 2500 4125

RM 2375 - 2250 3450

RM 2125 - 1875 3200

Track application L

RM 3000 - 2875 4375

RM 2750 - 2250 4125

RM 2125 - 1875 3450

##### ITO 400 FU

Track application N/L

RM 3000 - 2625 4850

RM 2500 - 1875 3850

#### Required headroom STH

##### SupraMatic HT / ITO 400 FU

Track application N 390

Track application L 260

##### WA 300 S4 / WA 400 FU

Track application N 390

Track application L 200

##### Sideroom SA

> 125

With operator WA 300 S4 > 200

With operator WA 400 FU > 200

For additional sizes and equipment options, please see the product brochures and technical manual.

# Technical data

## High-speed sectional door HS 5015 PU N42

### Vertical view

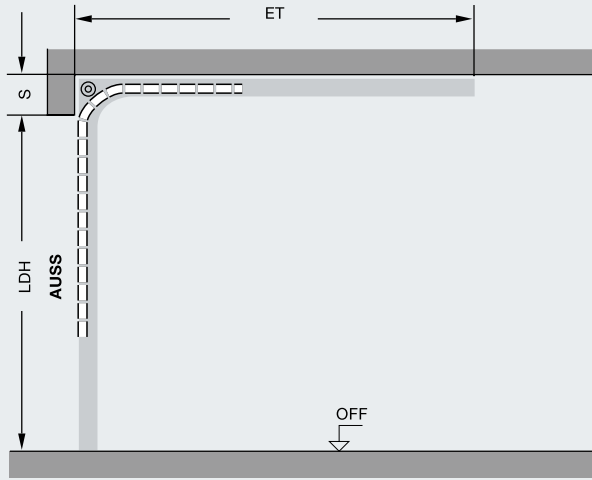

### Horizontal view

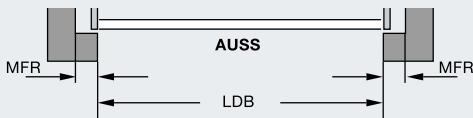

### Explanation of dimensions

LDB	Clear passage width
LDH	Clear passage height
ET	Distance back
S	Required headroom
MFR	Space for fitting the door

**Clear passage width LDB** = door width (ordering size)

**Clear passage height LDH** = door height (ordering size)

#### Fitting depth ET

H = 480	> LDH + 520
H = 750	> LDH + 250

#### Required headroom S

For full passage height 480 – 750

#### Side space requirement PS

Bearing side	365
Operator side	535

### Size range

Max. width	5000
Max. height	3000

For additional sizes and equipment options, please see the product brochures and technical manual.



# Technical data

## Up-and-over door N 500

### Vertical view

#### Fitting behind the opening

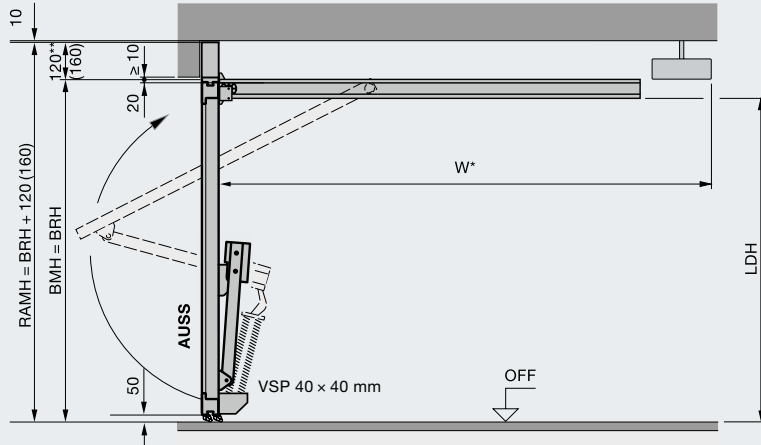

### Horizontal view

#### Fitting behind the opening

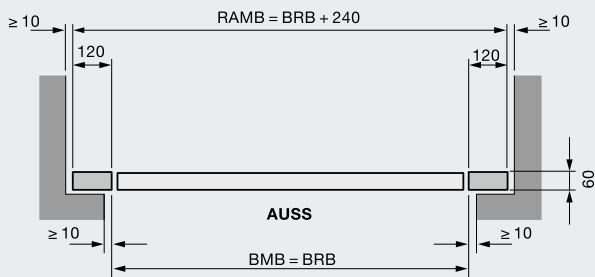

#### Fitting in the opening

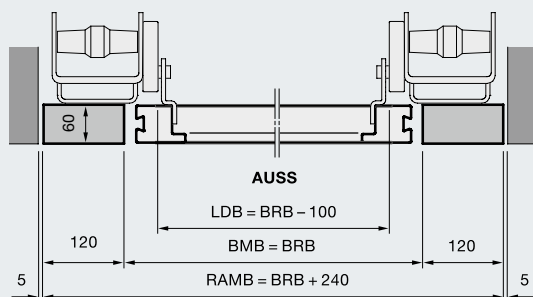

### Size range

Max. width	5000
Max. height	2750

Dimensions in mm

### Explanation of dimensions

BMB	Ordering size width
BMH	Ordering size height
BRB	Nominal size width
BRH	Nominal size height
LDB	Clear passage width
LDH	Clear passage height
RAMB	Overall frame dimension width
RAMH	Overall frame dimension height
W	Total distance back of operator boom including operator head
OFF	Finished floor level
AUSS	Exterior
VSP	Reinforcement profile from BRB $\geq$ 4000

### Clear passage height LDH

BRB < 3995	BRH - 130
BRB $\geq$ 4000	BRH - 170

### Distance back with operator W

BRH $\leq$ 2500	3200
BRH $\geq$ 2505	3450

For additional sizes and equipment options, please see the product brochures and technical manual.

\* Total length for door operators:

BRH 2000 - 2500 mm SupraMatic with K-boom	W = 3200 mm
BRH 2505 - 2750 mm SupraMatic with M-boom	W = 3450 mm

\*\* 120 mm infill thickness max. 20 mm  
160 mm infill thickness max. 45 mm

# Technical data

## Up-and-over door N 80

### Vertical view

Fitting behind the opening

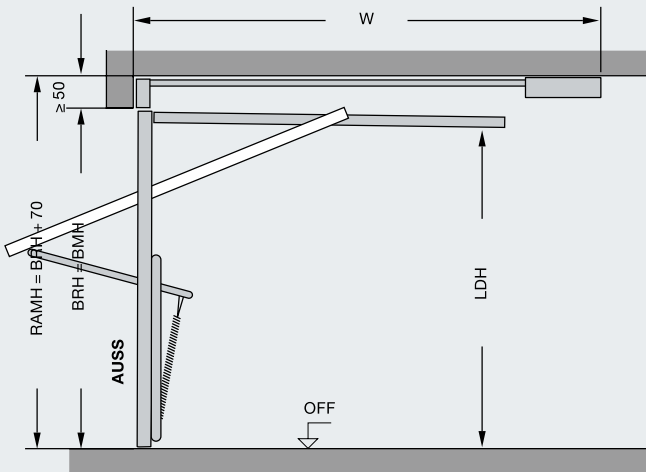

### Horizontal view

Fitting behind the opening

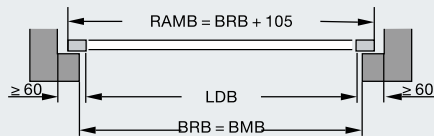

### Explanation of dimensions

BMB	Ordering size width
BMH	Ordering size height
BRB	Nominal size width
BRH	Nominal size height
LDB	Clear passage width
LDH	Clear passage height
RAMB	Overall frame dimension width
RAMH	Overall frame dimension height
W	Distance back with operator

**Clear passage width LDB** =  $BRB - 140$

**Clear passage height LDH** =  $BRH - 90$

#### Distance back with operator W

$BRH \leq 2500$	3200
$BRH \geq 2505$	3450

### Size range

Max. width	5000
Max. height	2750

For additional sizes and equipment options, please see the product brochures and technical manual.

# Hörmann Product Range

Everything from a single source for your construction project



**Quick service with testing, maintenance and repairs**  
 Our extensive service network means that we are always nearby and at your service around the clock.

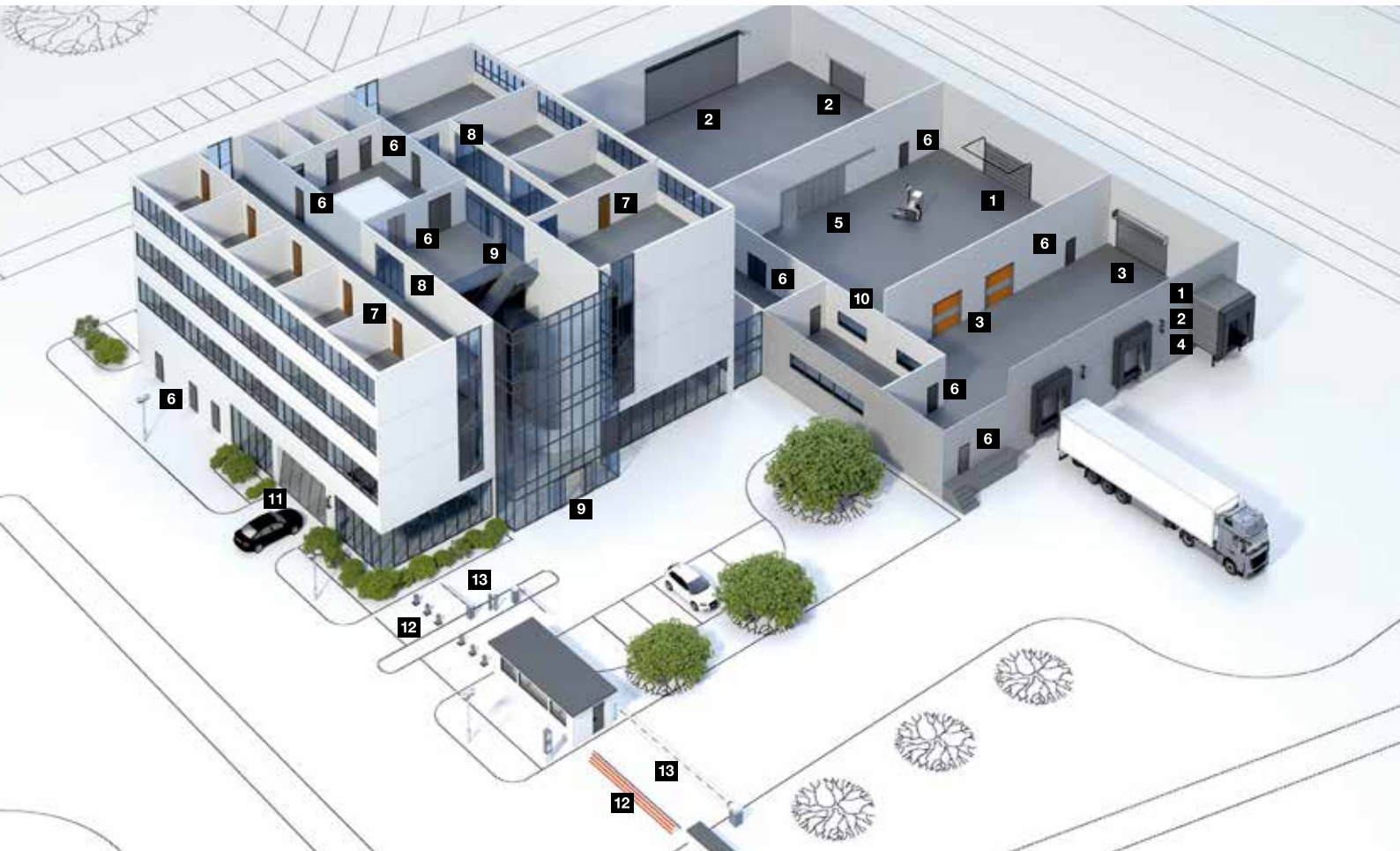

**1** Sectional doors



**2** Rolling shutters and rolling grilles



**3** High-speed doors



**4** Loading technology



**5** Steel and stainless steel sliding doors



**6** Steel and stainless steel construction project doors



**7** Steel frames with high-quality timber function doors from Schörghuber

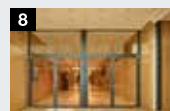

**8** Tubular frame construction project doors



**9** Automatic sliding doors

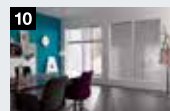

**10** Visibility window



**11** Collective garage doors



**12** Bollards and road blockers



**13** Barrier and pay station systems

# Hörmann: Quality without Compromise



Hörmann KG Amshausen, Germany



Hörmann KG Antriebstechnik, Germany



Hörmann KG Brandis, Germany



Hörmann KG Brockhagen, Germany



Hörmann KG Dissen, Germany



Hörmann KG Eckelhausen, Germany



Hörmann KG Freisen, Germany



Hörmann KG Ichttershausen, Germany



Hörmann KG Werne, Germany



Hörmann Alkmaar B.V., Netherlands



Hörmann Legnica Sp. z o.o., Poland



Hörmann Beijing, China



Hörmann Tianjin, China



Hörmann LLC, Montgomery IL, USA



Hörmann Flexon LLC, Burgettstown PA, USA



Shakti Hörmann Pvt. Ltd., India

Hörmann is the only manufacturer worldwide that offers you a complete range of all major building products from one source. We manufacture in highly-specialised factories using the latest production technologies. The close-meshed network of sales and service companies throughout Europe, and activities in the USA and Asia, make Hörmann your strong partner for first-class building products, offering “Quality without Compromise”.

**GARAGE DOORS**  
**OPERATORS**  
**INDUSTRIAL DOORS**  
**LOADING EQUIPMENT**  
**HINGED DOORS**  
**DOOR FRAMES**

**HÖRMANN**