



Sectional garage doors

Technical manual
Status 03.2019

HÖRMANN

Table of contents

Contents	Page
Door type / leaf	3 – 4
Door type / leaf	4
LTE 42, S-ribbed, Woodgrain	5
LTE 42, M-ribbed, Woodgrain	6
LTE 42, S-panelled, Woodgrain	7
LPU 42, S-ribbed, Woodgrain	8
LPU 42, M-ribbed, Woodgrain	9
LPU 42, M-ribbed, Deco-, Sand-, or Silkgrain	10
LPU 42, L-ribbed, Woodgrain	11
LPU 42, L-ribbed, Deco-, Sand-, Silk- or Duragrain	12
LPU 42, D- / T-ribbed, Silkgrain	13
LPU 42, S-panelled, Woodgrain	14
LPU 42, S-panelled, Decograin	15
ART 42 aluminium	16
LPU 67 Thermo, L- / M-ribbed, Deco- or Silkgrain	17
Sunrise glazing LTE 42 / LPU 42	18
Design element LPU 42, L-ribbed	19
Design element LPU 42, D- / T- / M-ribbed	20
LPU 42 with wicket door with trip-free threshold, S- / M- / L-ribbed, Deco-, Sand-, Silk- or Woodgrain	21 – 22
LPU 42 with wicket door with trip-free threshold, S- / M- / L-ribbed, matching exterior view for doors with glazing	23
LPU 42 with wicket door with trip-free threshold, S-panelled, Deco- or Woodgrain	24
LPU 42 with wicket door with trip-free threshold, arrangement of the wicket door	25
LPU 42 with wicket door and threshold, S- / M- / L- / D- / T-ribbed, Deco-, Sand-, Silk- or Woodgrain	26
LPU 42 with wicket door and threshold rail, S-panelled, Deco- or Woodgrain	27
LTH 42, S- / M- / L-ribbed, V-panelled	28
LTH 42 with special designs	29
Track application Z	30
Track application N	31
Track application L	32
Track application H	33
Track application N with wicket door with trip-free threshold	34
Track application L with wicket door with trip-free threshold	35
Track application N with wicket door and threshold rail	36
Track application L with wicket door and threshold rail	37
Track application BZ	38
Track application BL	39
Track application BL with wicket door with trip-free threshold	40
Sideroom and lintel fitting	41 – 42
Sideroom and lintel fitting with ThermoFrame	43
Sideroom, renovation solution	44
Lintel fitting with fascia panels	45
Bottom edge	46 – 48
Fixed elements	49
Side doors NT 60 with corner frame made of aluminium profiles, standard and special sizes	50 – 51
Side doors NT 60 with block frame made of aluminium profiles, standard sizes	52 – 53
Side doors NT 60 with block frame made of aluminium profiles, special sizes	54 – 55
Double-leaf side doors NT 60 with block frame made of aluminium profiles	56
Side doors NT 60 ART 42 with corner frame made of aluminium profiles	57 – 58
Side doors NT 60 ART 42 with block frame made of aluminium profiles	59 – 60
Double-leaf hinged door DFT 42 with block frame made of aluminium profiles	61
Timber side doors NT 60, standard sizes / special sizes	62

Please always take the country-specific building regulations into account!
 Door leaf constructions and track applications as well as fitting examples are provided in this manual.
 Before fitting a sectional door, the door opening must be finished and the garage floor must be laid and level.

No part may be reproduced without our prior permission.
 All rights reserved
 All dimensions in mm
 Subject to design changes

Door type	Door leaf
Sectional door LTE 42 – single-skinned steel sections	
<ul style="list-style-type: none"> • S-ribbed Woodgrain • M-ribbed Woodgrain 	<ul style="list-style-type: none"> • Single-skinned door sections, Woodgrain-embossed • Door sections of equal height, horizontally ribbed, made of hot-galvanized sheet steel • Surface with polyester-primer coating
<ul style="list-style-type: none"> • S-panelled Woodgrain 	<ul style="list-style-type: none"> • Single-skinned door sections, Woodgrain-embossed • Hot-galvanized sheet steel door sections of equal height with panelling • Surface with polyester-primer coating
Sectional door LPU 42 – Double-skinned steel sections	
<ul style="list-style-type: none"> • S-ribbed Woodgrain • M-ribbed Deco-, Sand-, Silk- or Woodgrain • L-ribbed Deco-, Sand-, Silk-, Wood- or Duragrain • D- and T-ribbed Silkgrain 	<ul style="list-style-type: none"> • Double-skinned, PU-foamed door sections, Deco-, Sand-, Silk- or Woodgrain exterior, Stucco-textured interior • Door sections of equal height, horizontally ribbed or without ribbing, made of hot-galvanized sheet steel • Surface with polyester-primer coating <ul style="list-style-type: none"> – For Decograin, plastic film coating on the outside – For Duragrain decor coating with high-strength coating, authentic exterior surface finish look
<ul style="list-style-type: none"> • S-panelled Deco- or Woodgrain 	<ul style="list-style-type: none"> • Double-skinned, PU-foamed door sections, Deco- or Woodgrain exterior, Stucco-textured interior • Hot-galvanized sheet steel door sections of equal height with panelling • Surface with polyester-primer coating (with Decograin, plastic film coating on the outside)
Sectional door LPU 67 Thermo – double-skinned steel sections with thermal break	
<ul style="list-style-type: none"> • M-ribbed Deco- or Silkgrain • L-ribbed Deco- or Silkgrain 	<ul style="list-style-type: none"> • Double-skinned, PU-foamed door sections, with thermal break, Deco- or Silkgrain exterior, Stucco-textured interior • Door sections of equal height, horizontally ribbed or without ribbing, made of hot-galvanized sheet steel • Surface with polyester-primer coating (with Decograin, plastic film coating on the outside)
Sectional door LPU 42 with wicket door – Double-skinned steel sections	
<ul style="list-style-type: none"> • M-ribbed Deco- or Silkgrain • L-ribbed Deco- or Silkgrain 	<ul style="list-style-type: none"> • Double-skinned, PU-foamed door sections, Deco-, Sand-, Silk- or Woodgrain exterior, Stucco-textured interior • Door sections of equal height, horizontally ribbed or without ribbing, made of hot-galvanized sheet steel • Surface with polyester-primer coating (with Decograin, plastic film coating on the outside) • Without door handle set / inside locking • We recommend fitting a SupraMatic P garage door operator.
<ul style="list-style-type: none"> • S-panelled Deco- or Woodgrain 	<ul style="list-style-type: none"> • Double-skinned, PU-foamed door sections, Deco- or Woodgrain exterior, Stucco-textured interior • Hot-galvanized sheet steel door sections of equal height with panelling • Surface with polyester-primer coating • Without door handle set / inside locking • We recommend fitting a SupraMatic P garage door operator.
Sectional door ART 42 aluminium	
<ul style="list-style-type: none"> • Aluminium frame door section 	<ul style="list-style-type: none"> • Glazed aluminium sectional door made of extruded aluminium tube profiles with polyester-primer coating on both sides • Door sections of equal height in the standard version or with thermal break • With uniform field division along the width • We recommend fitting a SupraMatic P garage door operator.

See brochure material for additional details.

Door type	Door leaf
Sectional door LTH 42	
<ul style="list-style-type: none"> • S-ribbed, Nordic Pine / Hemlock • M-ribbed, Nordic Pine / Hemlock • L-ribbed, Nordic Pine / Hemlock • V-panelled, Nordic Pine / Hemlock 	<ul style="list-style-type: none"> • Solid timber door sections, S- / M- / L-ribbed or V-panelled • Door sections of equal height • Surface impregnated against blue stain and wood pests • Optionally brushed surface finish (not possible for V-panelled version) • Glazings not possible in the two bottom door sections
Sectional door LTH 42 with special designs	
Nordic Pine / Hemlock	<ul style="list-style-type: none"> • Solid timber sections with different door styles • Door sections of equal height • Surface impregnated against blue stain and wood pests • Optionally brushed surface finish • Door styles 403 and 404 with natural stone infill on request
Side doors with corner frame made of aluminium profiles	
Standard sizes	<ul style="list-style-type: none"> • Appearance same as LTE 42 / LPU 42 / 67 / ART 42, leaf frame made of extruded aluminium profiles, depth 60 mm • Door infill made of PU-foamed steel sections, Deco-, Sand-, Silk- or Woodgrain exterior, Stucco-textured interior • Surface with polyester-primer coating (with Decograin, plastic film coating on the outside)
Side doors with block frame made of aluminium profiles	
Standard / special sizes	<ul style="list-style-type: none"> • Appearance same as LTE 42 / LPU 42 / 67 / ART 42, door leaf frame and frame made of extruded aluminium profiles (without thermal break), depth 60 mm, double door seal on 3 sides • Door infill made of PU-foamed steel sections, Deco-, Sand-, Silk- or Woodgrain exterior, Stucco-textured interior • Surface with polyester-primer coating (with Decograin, plastic film coating on the outside)
Hinged door with block frame made of aluminium profiles	<ul style="list-style-type: none"> • Appearance same as LTE 42 / LPU 42 / 67, door leaf frame and frame made of extruded aluminium profiles (without thermal break), depth 60 mm, double door seal on 3 sides • Door infill made of PU-foamed steel sections, Deco-, Sand-, Silk- or Woodgrain exterior, Stucco-textured interior • Surface with polyester-primer coating (with Decograin, plastic film coating on the outside)
Timber side doors	
Standard / special sizes	<ul style="list-style-type: none"> • Appearance same as LTH 40 • Solid timber door leaf and frame, Nordic Pine or Hemlock, door leaf depth 42 mm, door seal on 3 sides • Double seal in threshold area • Surface impregnated against blue stain and wood pests

See brochure material for additional details.

Sectional door LTE 42

Single-skinned steel sections

S-ribbed

Woodgrain

External views

(The dimensions shown correspond to size 2500 × 2125 mm. Deviations may occur with other door sizes.)

Basic model

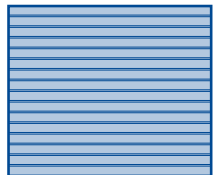

With aluminium frame

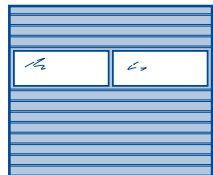

With glazing type D

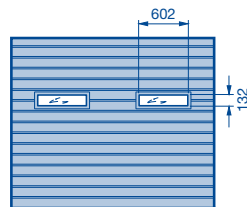

Note:

Different glazing arrangements are not possible!

Size range

Door width in 1 mm increments, door height in grid height. Intermediate heights are not possible.

		A	B	C										
RM	3000	6	500	125										
	2875	6	479	120										
	2750	5	550	138										
	2625	5	525	131										
	2500	5	500	125										
	2375	5	475	119										
	2250	4	562	141										
	2205	4	550	138										
	2125	4	531	133										
	2080	4	520	130										
	2000	4	500	125										
	1955	4	488	122										
	1875	4	468	117										
		Number of infills per door section with glazing												
		2	3	4	5									
		2250	2375	2500	2750	3000	3250	3500	3750	4000	4250	4500	4750	5000
		LZ												

Doors with tension spring assembly

A No. of door sections

W Door section height

C Spacing

RM Grid height

LZ Clear frame dimensions (from 2000)

Special equipment

Ventilation

- Ventilation slots in bottom door section, ventilation cross section 65 cm² for one metre door width
 - Ventilation slots in bottom seal, ventilation cross section 65 cm² for one metre door width
 - Aluminium frame with expanded mesh, 58 % ventilation cross section
 - Aluminium frame with stainless steel crimped mesh*, mesh size 12 mm
 - Aluminium frame with stainless steel welded grille* (firefighting infill), mesh size 100 mm
- (* only for underground garage box doors)

Glazing options

- Aluminium frame (standard profile NF)
- Glazing type D, 3 mm

Sectional door LTE 42

Single-skinned steel sections

M-ribbed

Woodgrain

External views

(The dimensions shown correspond to size 2500 × 2125 mm. Deviations may occur with other door sizes.)

Basic model



With aluminium frame

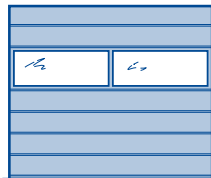

With glazing type D

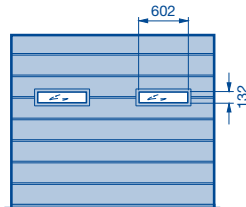

Note:

Different glazing arrangements are not possible!

Size range

Door width in 1 mm increments, door height in grid height. Intermediate heights are not possible.

													A	B	C					
RM	3000													6	500	250				
	2875													6	479	239				
	2750													5	550	275				
	2625													5	525	262				
	2500													5	500	250				
	2375													5	475	237				
	2250													4	562	281				
	2205													4	550	275				
	2125													4	531	265				
	2080													4	520	260				
	2000													4	500	250				
	1955													4	488	244				
	1875													4	468	234				
		2		3														Number of infills per door section with glazing		
		2250	2375	2500	2750	3000	3250	3500	3750	4000	4250	4500	4750	5000						
		LZ																		

Doors with tension spring assembly

A No. of door sections

W Door section height

C Spacing

RM Grid height

LZ Clear frame dimensions (from 2000)

Special equipment

Ventilation

- Ventilation slots in bottom door section, ventilation cross section 65 cm² for one metre door width
 - Ventilation slots in bottom seal, ventilation cross section 65 cm² for one metre door width
 - Aluminium frame with expanded mesh, 58 % ventilation cross section
 - Aluminium frame with stainless steel crimped mesh*, mesh size 12 mm
 - Aluminium frame with stainless steel welded grille* (firefighting infill), mesh size 100 mm
- (* only for underground garage box doors)

Glazing options

- Aluminium frame (standard profile NF)
- Glazing type D, 3 mm

Sectional door LTE 42

Single-skinned steel sections

S-panelled

Woodgrain

External views

(The dimensions shown correspond to size 2500 × 2125 mm. Deviations may occur with other door sizes.)

Basic model

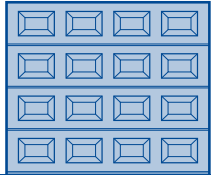

Style S0

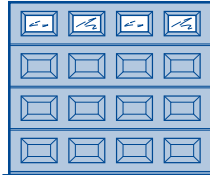

Style S1 with decorative rail (rhombus)

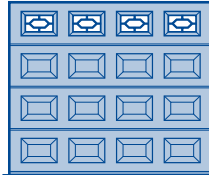

Style S2 with decorative rail (cross)

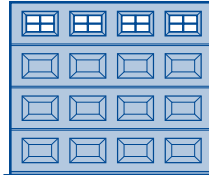

Style S10

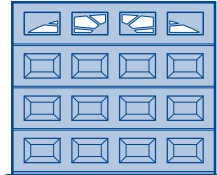

Size range

Door width in 1 mm increments, door height only in one of the grid heights shown. Intermediate heights are not possible.

														A	B							
RM	3000															6	500					
	2875															6	479					
	2750															5	550					
	2625															5	525					
	2500															5	500					
	2375															5	475					
	2250															4	562					
	2205															4	550					
	2125															4	531					
	2080															4	520					
	2000															4	500					
	1955															4	488					
	1875															4	468					
		3 → 2070	4 → 2740			5															Number of panels per door section	
			2250	2375	2500	2750	3000	3250	3500	3750	4000	4250	4500	4750	5000							
		LZ																				

- Doors with tension spring assembly
- A** No. of door sections
- W** Door section height
- RM** Grid height

- LZ** Clear frame dimensions (from 2000)
- Up to width

Special equipment

Ventilation

- Ventilation slots in bottom door section, ventilation cross section 65 cm² for one metre door width
- Ventilation slots in bottom seal, ventilation cross section 65 cm² for one metre door width

Glazing options – panel glazing

Clear or crystal structure panes, 3 mm

- Designs S0, S1, S2
- Designs S10, S20 (see page 18)

Sectional door LPU 42

Double-skinned steel sections

S-ribbed

Woodgrain

External views

(The dimensions shown correspond to size 2500 × 2125 mm. Deviations may occur with other door sizes.)

Basic model

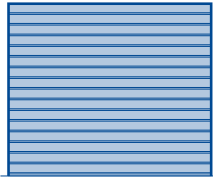

With aluminium frame NF / WF

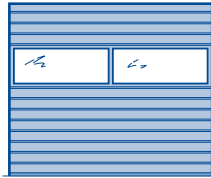

With glazing type D

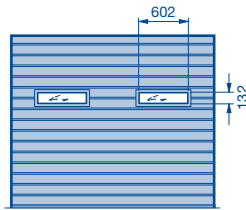

Size range

Door width in 1 mm increments, door height in grid height. Intermediate heights possible up to LZ = 5500 mm. All grid heights also possible in special 125 mm S-ribbed version (to manufacture doors with matching appearance and different RM).

RM						A	B	C	F													
	3000						6	500	125	2880 – 2920												
2875						6	479	120	2755 – 2800													
2750						5	550	138	2630 – 2655													
2625						5	525	131	2505 – 2535													
2500						5	500	125	2380 – 2420													
2375						5	475	119	2255 – 2300													
2250						4	562	141														
2205						4	550	138														
2125						4	531	133														
2080						4	520	130														
2000						4	500	125														
1955						4	488	122														
1875						4	468	117														
						4	6	12	No. of ventilation grilles with 40 cm ² ventilation cross section each													
						2	3	4	5	6	Number of infills per door section with glazing											
						2250	2375	2500	2750	3000	3250	3500	3750	4000	4250	4500	4750	5000	5250	5500	5750	6000
						LZ																

- Doors with tension spring assembly
- A** No. of door sections
- W** Door section height
- C** Spacing

- F** This range cannot be shortened (intermediate heights)
- RM** Grid height
- LZ** Clear frame dimensions (**from 2000**)

Special equipment

Ventilation

- Ventilation slots in bottom seal, ventilation cross section 65 cm² for one metre door width
 - Ventilation grille, ventilation cross section 40 cm² each
 - Aluminium frame with expanded mesh, 58 % ventilation cross section
 - Aluminium frame with stainless steel crimped mesh*, mesh size 12 mm
 - Aluminium frame with stainless steel welded grille* (firefighting infill), mesh size 100 mm
 - Folding roller bracket set / ventilation position (see page 42)
- (* only for underground garage box doors)

Glazing options

- Aluminium frame (standard profile NF or profile with thermal break WF)
- Glazing type D, 16 mm

Sectional door LPU 42

Double-skinned steel sections

M-ribbed

Woodgrain

External views

(The dimensions shown correspond to size 2500 × 2125 mm. Deviations may occur with other door sizes.)

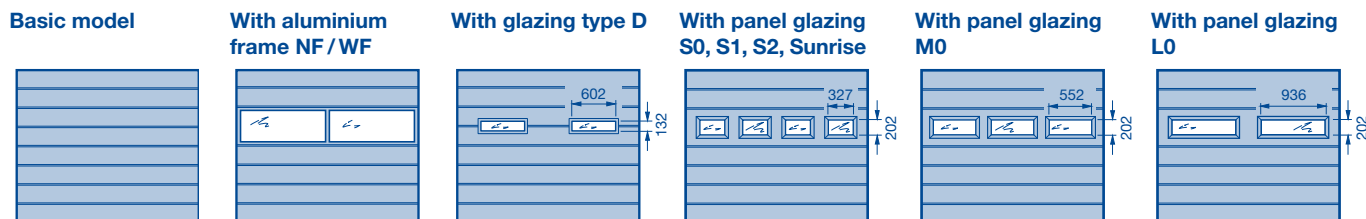

Size range

Door width in 1 mm increments, door height in grid height. Intermediate heights are possible up to LZ = 5500 mm.

RM													A	B	C			
	3000													6	500	250		
2875													6	479	239			
2750													5	550	275			
2625													5	525	262			
2500													5	500	250			
2375													5	475	237			
2250													4	562	281			
2205													4	550	275			
2125													4	531	265			
2080													4	520	260			
2000													4	500	250			
1955													4	488	244			
1875													4	468	234			
		4		6		8		10		12	No. of ventilation grilles with 40 cm ² ventilation cross section each							
		2		3		4		5		6	Number of glazings – aluminium frame and type D							
	3 → 2125	4		5		6		7		8	9	No. of glazings – type S						
	2 → 2240	3 → 2970		4 → 3690		5 → 4420		6 → 5140		7	8	No. of glazings – type M						
		2 → 3400				3 → 4490			4		5	No. of glazings – type L						
		2250	2375	2500	2750	3000	3250	3500	3750	4000	4250	4500	4750	5000	5250	5500	5750	6000
		LZ																

- Doors with tension spring assembly
- A** No. of door sections
- W** Door section height
- C** Spacing

- RM** Grid height
- LZ** Clear frame dimensions (from 2000)
- Up to width

Special equipment

Ventilation

- Ventilation slots in bottom seal, ventilation cross section 65 cm² for one metre door width
 - Ventilation grille, ventilation cross section 40 cm² each
 - Aluminium frame with expanded mesh, 58 % ventilation cross section
 - Aluminium frame with stainless steel crimped mesh*, mesh size 12 mm
 - Aluminium frame with stainless steel welded grille* (firefighting infill), mesh size 100 mm
 - Folding roller bracket set / ventilation position (see page 42)
- (* only for underground garage box doors)

Glazing options

- Aluminium frame (standard profile NF or profile with thermal break WF)
- Glazing type D, 16 mm
- Panel glazing type S, M or L, 22 mm

Design elements

- Design inlay elements (see page 20)

Sectional door LPU 42

Double-skinned steel sections

M-ribbed

Deco-, Sand-, or Silkgrain

External views

(The dimensions shown correspond to size 2500 × 2125 mm. Deviations may occur with other door sizes.)

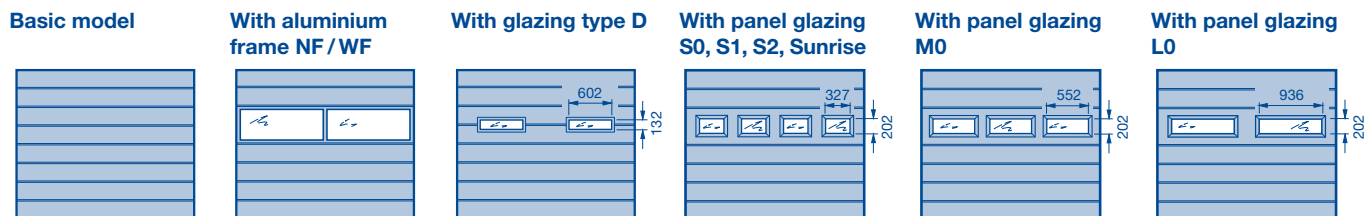

Size range

Door width in 1 mm increments up to LZ = 5500 mm, door height in grid height. Intermediate heights are possible.

RM													A	B	C			
	3000														6	500	250	
2875																		
2750															5	550	275	
2625																		
2500															5	500	250	
2375															5	475	237	
2250															4	562	281	
2205															4	550	275	
2125															4	531	265	
2080															4	520	260	
2000															4	500	250	
1955															4	488	244	
1875															4	468	234	
		4		6		8		10		12	No. of ventilation grilles with 40 cm ² ventilation cross section each							
		2		3		4		5		6	Number of glazings – aluminium frame and type D							
	3 → 2125	4		5		6		7		8		9	No. of glazings – type S					
	2 → 2240	3 → 2970		4 → 3690		5 → 4420		6 → 5140		7		8	No. of glazings – type M					
		2 → 3400		3 → 4490		4		5	No. of glazings – type L									
		2250	2375	2500	2750	3000	3250	3500	3750	4000	4250	4500	4750	5000	5250	5500	5750	6000
		LZ																

Doors with tension spring assembly (3000 × 2625 mm for Silkgrain)

A No. of door sections
W Door section height

C Spacing
RM Grid height
LZ Clear frame dimensions (from 2000)
→ Up to width

Door size not possible for Silkgrain

Special equipment

Ventilation

- Ventilation slots in bottom seal, ventilation cross section 65 cm² for one metre door width
 - Ventilation grille, ventilation cross section 40 cm² each
 - Aluminium frame with expanded mesh, 58 % ventilation cross section
 - Aluminium frame with stainless steel crimped mesh*, mesh size 12 mm
 - Aluminium frame with stainless steel welded grille* (firefighting infill), mesh size 100 mm
 - Folding roller bracket set / ventilation position (see page 42)
- (* only for underground garage box doors)

Glazing options

- Aluminium frame (standard profile NF or profile with thermal break WF)
- Glazing type D, 16 mm
- Panel glazing type S, M or L, 22 mm

Design elements

- Design inlay elements (see page 20)

Sectional door LPU 42

Double-skinned steel sections

L-ribbed

Woodgrain

External views

(The dimensions shown correspond to size 2500 × 2125 mm. Deviations may occur with other door sizes.)

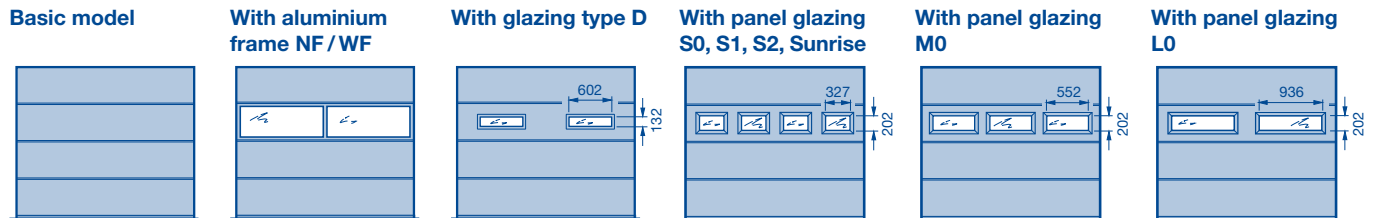

Size range

Door width in 1 mm increments, door height in grid height. Intermediate heights are possible up to LZ = 5500 mm in certain areas.

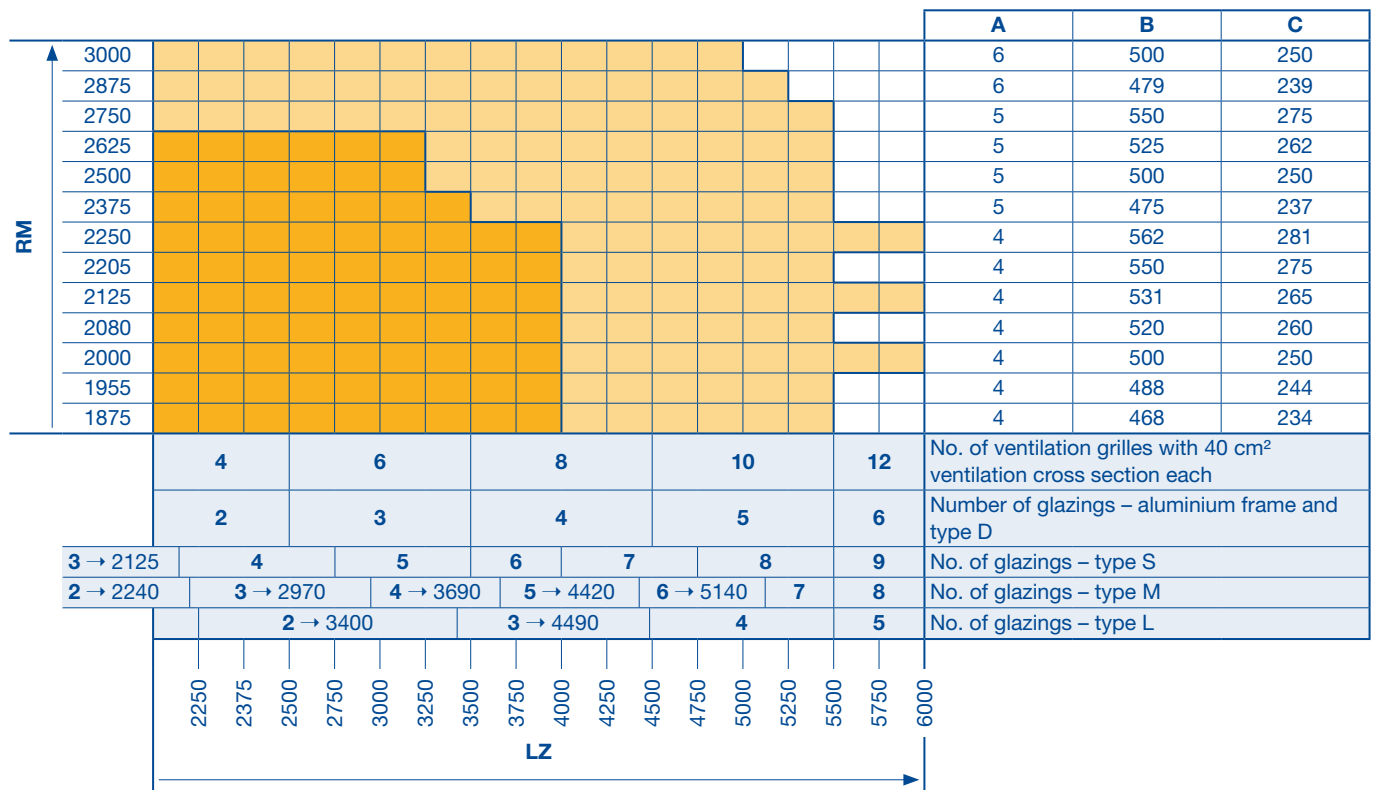

- Doors with tension spring assembly
- A** No. of door sections
- W** Door section height
- C** Spacing
- RM** Grid height
- LZ** Clear frame dimensions (from 2000)
- Up to width

Special equipment

Ventilation

- Ventilation slots in bottom seal, ventilation cross section 65 cm² for one metre door width
 - Ventilation grille, ventilation cross section 40 cm² each
 - Aluminium frame with expanded mesh, 58 % ventilation cross section
 - Aluminium frame with stainless steel crimped mesh*, mesh size 12 mm
 - Aluminium frame with stainless steel welded grille* (firefighting infill), mesh size 100 mm
 - Folding roller bracket set / ventilation position (see page 42)
- (* only for underground garage box doors)

Glazing options

- Aluminium frame (standard profile NF or profile with thermal break WF)
- Glazing type D, 16 mm
- Panel glazing type S, M or L, 22 mm

Design elements

- Styles and design glazings (see page 19)

Sectional door LPU 42

Double-skinned steel sections

L-ribbed

Deco-, Sand-, Silk- or Duragrain

External views

(The dimensions shown correspond to size 2500 × 2125 mm. Deviations may occur with other door sizes.)

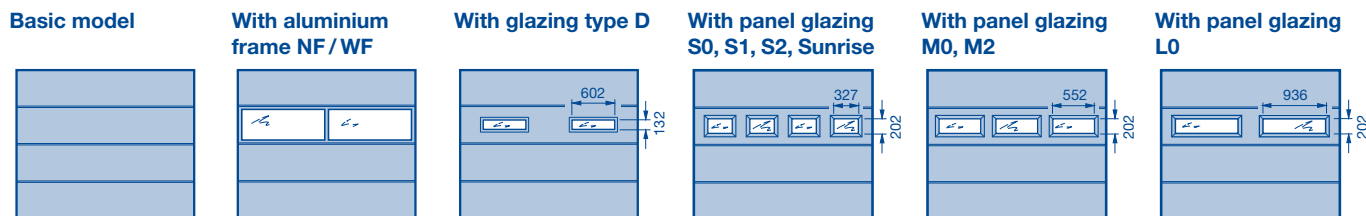

Size range

Door width in 1 mm increments, door height in grid height. Intermediate heights are possible up to LZ = 5500 mm in certain areas.

												A	B					
RM	3000											6	500					
	2875																	
	2750											5	550					
	2625																	
	2500											5	500					
	2375											5	475					
	2250											4	562					
	2205											4	550					
	2125											4	531					
	2080											4	520					
	2000											4	500					
	1955											4	488					
1875											4	468						
		4		6		8		10		12		No. of ventilation grilles with 40 cm ² ventilation cross section each						
		2		3		4		5		6		Number of glazings – aluminium frame and type D						
3 → 2125		4		5		6		7		8		9		No. of glazings – type S				
2 → 2240		3 → 2970		4 → 3690		5 → 4420		6 → 5140		7		8		No. of glazings – type M				
		2 → 3400		3 → 4490		4		5				5		No. of glazings – type L				
		2250	2375	2500	2750	3000	3250	3500	3750	4000	4250	4500	4750	5000	5250	5500	5750	6000
		LZ																

- Doors with tension spring assembly (3000 × 2625 mm for Silkgrain)
- A** No. of door sections
- W** Door section height

- RM** Grid height
- LZ** Clear frame dimensions (from 2000)
- Up to width
- Door size not possible for Silkgrain

Note:
Duragrain only possible up to LZ ≤ 5500.

Special equipment

Ventilation

- Ventilation slots in bottom seal, ventilation cross section 65 cm² for one metre door width
 - Ventilation grille, ventilation cross section 40 cm² each
 - Aluminium frame with expanded mesh, 58 % ventilation cross section
 - Aluminium frame with stainless steel crimped mesh*, mesh size 12 mm
 - Aluminium frame with stainless steel welded grille* (firefighting infill), mesh size 100 mm
 - Folding roller bracket set / ventilation position (see page 42)
- (* only for underground garage box doors)

Glazing options

- Aluminium frame (standard profile NF or profile with thermal break WF)
- Glazing type D, 16 mm
- Panel glazing type S, M or L, 22 mm

Design elements

- Styles and design glazings (see page 19)

Sectional door LPU 42

Double-skinned steel sections

D- / T-ribbed

Silkgrain

External views

(The dimensions shown correspond to size 2500 × 2125 mm. Deviations may occur with other door sizes.)

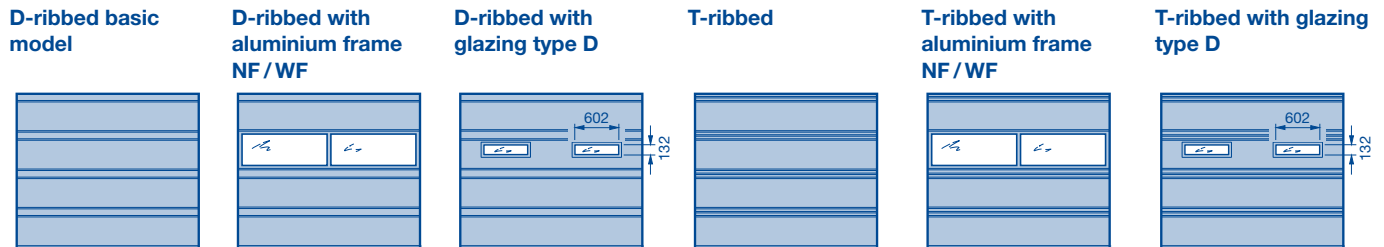

Size range

Door width in 1 mm increments, door height in grid height. Intermediate heights are possible up to LZ = 5500 mm in certain areas.

												A	B	F (D-ribbed)	F (T-ribbed)										
RM	3000											6	500	2895 – 2930 2755 – 2870	2950 – 2985 2895 – 2930 2755 – 2870										
	2875																								
	2750																					5	550	2645 – 2680 2505 – 2570	2700 – 2735 2645 – 2680 2505 – 2570
	2625																								
	2500																					5	500	2395 – 2430	2450 – 2485 2380 – 2430
	2375																					5	475	2255 – 2305	2325 – 2360 2255 – 2305
	2250																					4	562		2210 – 2235
	2205																					4	550	2130	2150 – 2185 2130 – 2135
	2125																					4	531		2085 – 2110
	2080																					4	520	2005 – 2010	2030 – 2065 2005 – 2010
	2000																					4	500		1960 – 1985
	1955																					4	488	1880 – 1885	1900 – 1940 1880 – 1885
1875											4	468	1805 – 1880	1820 – 1860 1800 – 1805											
		4		6		8		10		12		No. of ventilation grilles with 40 cm ² ventilation cross section each													
		2		3		4		5		6		Number of glazings – aluminium frame and type D													
		2250	2375	2500	2750	3000	3250	3500	3750	4000	4250	4500	4750	5000	5250	5500	5750	6000							
		LZ																							

Doors up to 3000 × 2625 mm with tension spring assembly

A No. of door sections

W Door section height

F This range cannot be shortened (intermediate heights)

RM Grid height

LZ Clear frame dimensions (from 2000)

→ Up to width

Special equipment

Ventilation

- Ventilation slots in bottom seal, ventilation cross section 65 cm² for one metre door width
 - Ventilation grille, ventilation cross section 40 cm² each
 - Aluminium frame with expanded mesh, 58 % ventilation cross section
 - Aluminium frame with stainless steel crimped mesh*, mesh size 12 mm
 - Aluminium frame with stainless steel welded grille* (firefighting infill), mesh size 100 mm
 - Folding roller bracket set/ ventilation position (see page 42)
- (* only for underground garage box doors)

Glazing options

- Aluminium frame (standard profile NF or profile with thermal break WF)
- Glazing type D, 16 mm

Design elements

- Styles and design glazings (see page 19)
- Design inlay elements (see page 20)

Sectional door LPU 42

Double-skinned steel sections

S-panelled

Woodgrain

External views

(The dimensions shown correspond to size 2500 × 2125 mm. Deviations may occur with other door sizes.)

Basic model

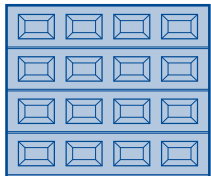

Style S0

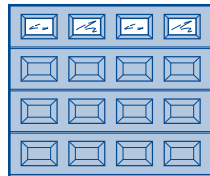

Style S1 with decorative rail (diamond)

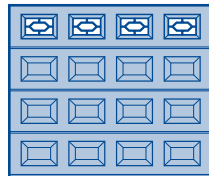

Style S2 with decorative rail (cross)

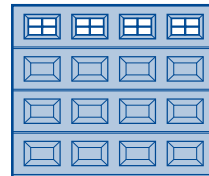

Style S10

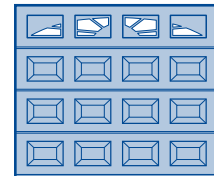

Size range

Door width in 1 mm increments, door height in grid height. Intermediate heights are possible up to LZ = 5500 mm in certain areas.

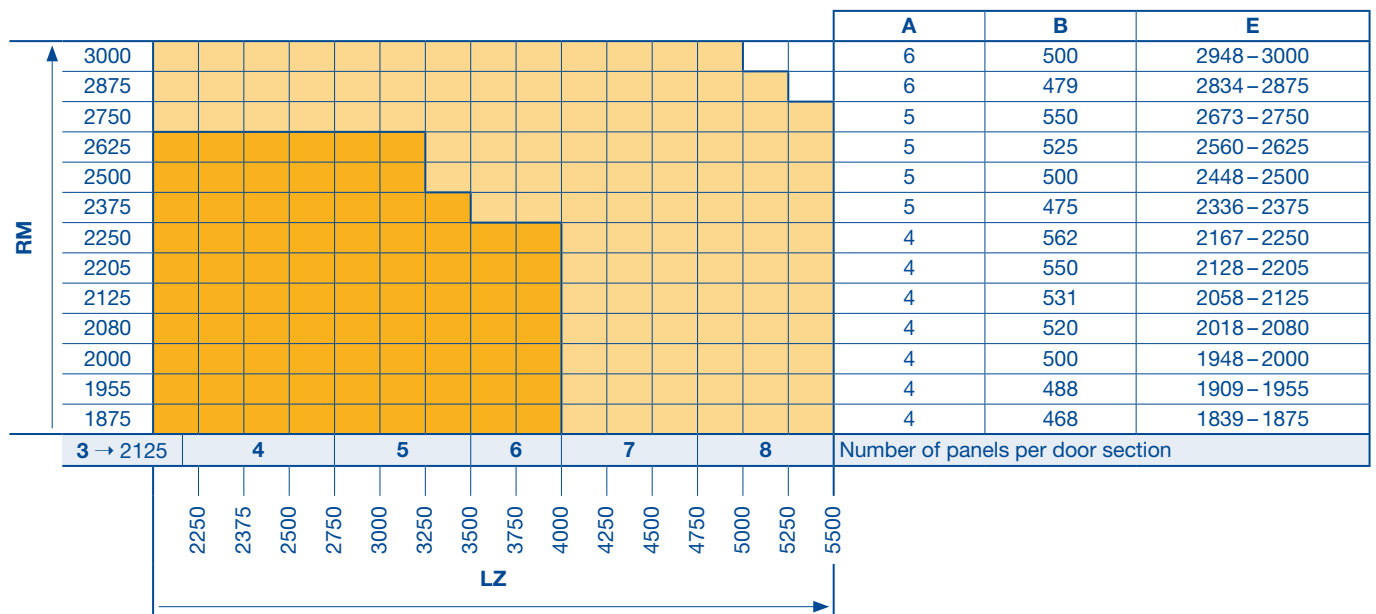

Doors with tension spring assembly

A No. of door sections

W Door section height

E This range can be shortened (intermediate heights, shortening only possible from top)

RM Grid height

LZ Clear frame dimensions (from 2000)

→ Up to width

Special equipment

Ventilation

- Ventilation slots in bottom seal, ventilation cross section 65 cm² for one metre door width
- Folding roller bracket set / ventilation position (see page 42)

Glazing options – panel glazing

Clear or crystal structure double panes, 16 mm

- Styles S0, S1, S2
- Styles S10, S20, S30, S40, S50, S60 (see page 18)

Sectional door LPU 42

Double-skinned steel sections

S-panelled

Decograin

External views

(The dimensions shown correspond to size 2500 × 2125 mm. Deviations may occur with other door sizes.)

Basic model

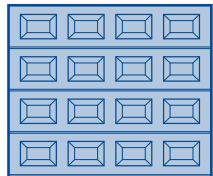

Style S0

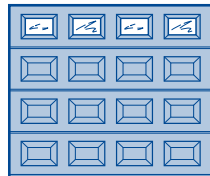

Style S1 with decorative rail (rhombus)

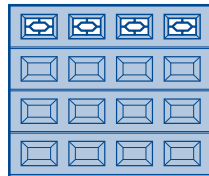

Style S2 with decorative rail (cross)

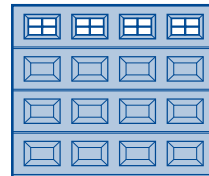

Style S10

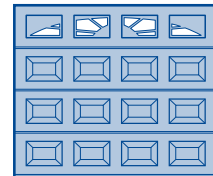

Size range

Door width in 1 mm increments, door height in grid height. Intermediate heights are possible up to LZ = 5500 mm in certain areas.

		A	B	E
RM	3000	6	500	2948 – 3000
	2875			
	2750			
	2625			
	2500	5	500	2448 – 2500
	2375	5	475	2336 – 2375
	2250	4	562	2167 2250
	2205			
	2125	4	531	2058 – 2125
	2080			
	2000	4	500	1948 – 2000
	1955			
	1875	4	468	1839 – 1875
3 → 2125		Number of panels per door section		
		2250 2375 2500 2750 3000 3250 3500 3750 4000 4250 4500 4750 5000 5250 5500		
		LZ		

Doors with tension spring assembly

A No. of door sections

W Door section height

E This range can be shortened (intermediate heights, shortening only possible from top)

RM Grid height

LZ Clear frame dimensions (from 2000)

→ Up to width

Special equipment

Ventilation

- Ventilation slots in bottom seal, ventilation cross section 65 cm² for one metre door width
- Folding roller bracket set / ventilation position (see page 42)

Glazing options – panel glazing

Clear or crystal structure double panes, 16 mm

- Styles S0, S1, S2
- Styles S10, S20, S30, S40, S50, S60 (see page 18)

Sectional door ART 42 aluminium

Aluminium extrusion door sections

External views

(The illustrations correspond to size 2500 × 2125 mm. Deviations may occur with other door sizes.)

Basic model with aluminium frame NF / WF



Note:

The door leaf of the basic model (standard) consists of door sections of equal height.
The openings have different heights with this variant. Identical openings are possible as a special variant.
The ART42 is only possible with operator actuation.

Size range

Door width in 1 mm increments, door height in grid height. Intermediate heights are not possible up to LZ = 5500 mm.

							A	B										
RM	3000						6	500										
	2875						6	479										
	2750						5	550										
	2625						5	525										
	2500						5	500										
	2375						5	475										
	2250						4	562										
	2205						4	550										
	2125						4	531										
	2080						4	520										
	2000						4	500										
	1955						4	488										
	1875						4	468										
		Number of glazings per door section*																
		2	3	4	5													
		2250	2375	2500	2750	3000	3250	3500	3750	4000	4250	4500	4750	5000	5250	5500		
		LZ																

Doors up to 3000 × 2625 mm with tension spring assembly

A No. of door sections
W Door section height

C Spacing
RM Grid height
LZ Clear frame dimensions (from 2000)

* Additional rails possible after technical inspection
Maximum field width: 1277 mm
Minimum field width: 250 mm

Special equipment

Ventilation

- Perforated steel sheet made of stainless steel (LB), ventilation cross section = 58 % (colour coating of infill not possible)
- Expanded mesh made of stainless steel (SE), ventilation cross section = 58 % (colour coating of infill not possible)
- Crimped mesh, mesh size 12 mm
- Welded grille (firefighting infill), mesh size 100 mm
- Folding roller bracket set / ventilation position (see page 42)

Notes:

- Door sizes do not apply for expanded mesh infill, crimped mesh, welded grille and perforated sheet infill.
- Door sizes on request.
- Welded grille only for underground garage box doors.

Glazing options

- Synthetic double pane, clear / clear (S2), 26 mm
- Synthetic double pane, crystal structure / crystal structure (U2), 26 mm
- Synthetic double pane, grey tinted (A2), 26 mm
- Synthetic double pane, brown tinted (B2), 26 mm
- Synthetic double pane, white tinted (opal) (M2), 26 mm
- Polycarbonate double pane clear / clear (C2), 26 mm
- Double-moulded pane (S), 16 mm (only possible for NF)

Sectional door LPU 67 Thermo

Double-skinned steel sections with thermal break / depth 67 mm

M / L-ribbed

Deco- or Silkgrain

External views

(The dimensions shown correspond to size 2500 × 2125 mm. Deviations may occur with other door sizes.)

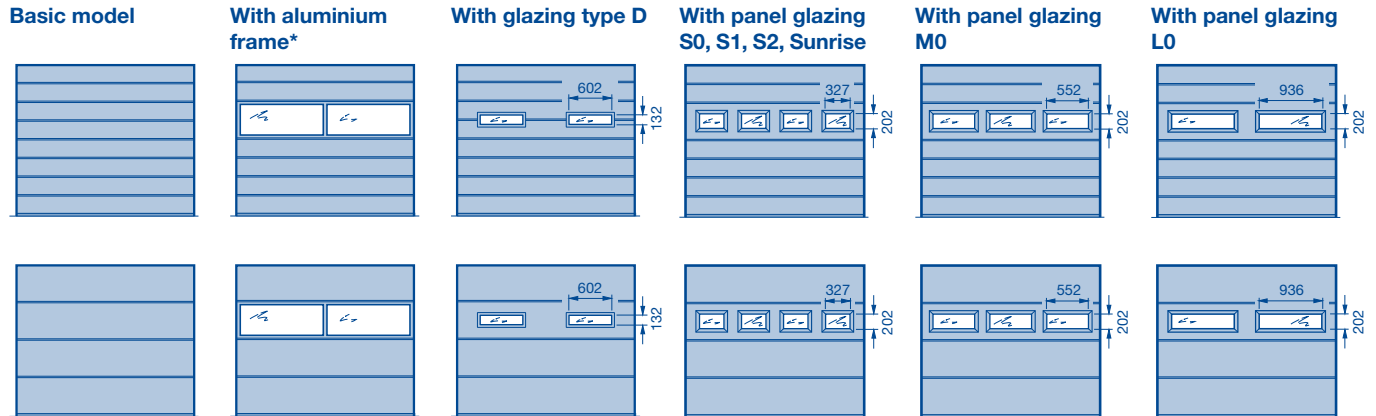

Size range

Door width in 5 mm increments up to LZ = 5000 mm, door height in grid height. Intermediate heights are possible.

										A	B			
RM	3000								●	●	●	6	500	
	2875													
	2750										●	5	550	
	2625													
	2500			■	■							5	500	
	2375			■	■							5	475	
	2250											4	562	
	2205											4	550	
	2125											4	531	
	2080											4	520	
	2000											4	500	
1955											4	488		
1875											4	468		
		2		3		4		5		Number of glazings – aluminium frame and type D				
	3 → 2125	4		5		6		7		8		No. of glazings – type S		
	2 → 2240	3 → 2970		4 → 3690		5 → 4420		6		No. of glazings – type M				
		2 → 3400				3 → 4490		4		No. of glazings – type L				
		2250	2375	2500	2750	3000	3250	3500	3750	4000	4250	4500	4750	5000
		LZ												

Doors up to 3000 × 2500 mm with tension spring assembly (not possible with aluminium frames)

A No. of door sections

W Door section height

RM Grid height

LZ Clear frame dimensions (from 2000)

→ Up to width

● Door size not possible for Silkgrain

■ Door size for Silkgrain only possible with track application N or L

* Technical inspection required

Sunrise glazing

For sectional doors

LTE 42 / LPU 42

External views

Sunrise glazing for sectional doors LTE/LPU 42 for standard and special sizes

Glazing options for S-panelled type (not possible for doors with 3 panels for each section)

Style S10

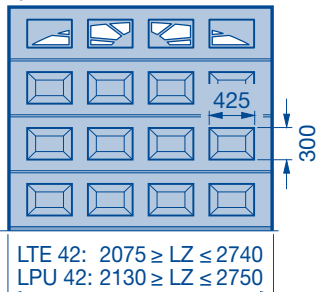

Style S20

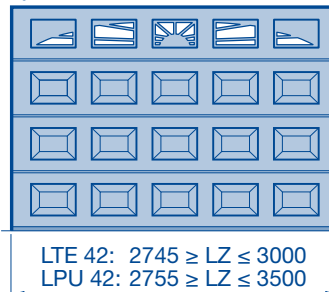

Style S30

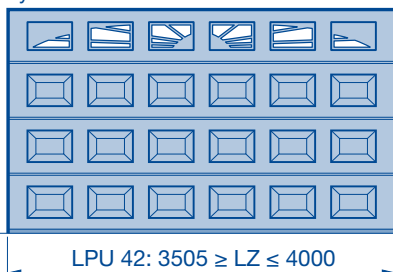

Style S40

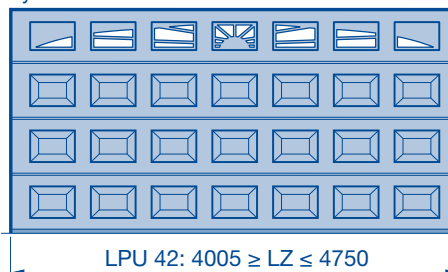

Style S50

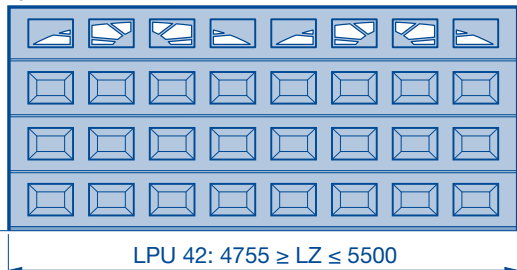

Style S60

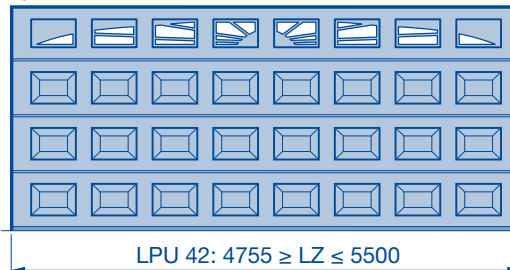

Design element

For sectional doors ¹⁾ and side doors

LPU 67 Deco- and Silkgrain

LPU 42 all surface finishes

Door view

Style arrangements (exterior views correspond with the door size 2500 × 2125 mm). Style sideroom 200 mm up to LZ = 3000 mm and 400 mm from LZ = 3005 mm (can be combined with design inlays).



Example:
Style 451 arrangement

1 Style 450 with stainless steel plinth profile, with square perforation (2-part over 3000 mm width)	1 Style 451 , stainless steel frame Style 461 , stainless steel frame and synthetic double pane ²⁾ or triple insulated glass pane	1 Style 452 , stainless steel frame with infill Style 462 , stainless steel frame with infill and synthetic double pane ²⁾
1 Style 453 , stainless steel frame with infill with small square Style 463* , stainless steel frame with infill with small square and synthetic double pane ²⁾	1 Style 454 , large stainless steel square	1 Style 455* , large and small stainless steel square
1 Style 456 , small stainless steel square (with style 450 optional plinth profile bottom section only with 2 squares)	1 Style 459 , with stainless steel ring Style 469 , with stainless steel ring and synthetic double pane ²⁾	1 Style 460* , stainless steel 150 × 150 mm
1 Style 471 , stainless steel frame Style 481 , stainless steel frame and synthetic double pane ²⁾ or triple insulated glass pane	1 Style 472* , stainless steel frame with infill Style 482* , stainless steel frame with infill and synthetic double pane ²⁾	1 Style 473 , stainless steel frame with infill with small square Style 483* , stainless steel frame with infill with small square and synthetic double pane ²⁾
1 Style 474* , large stainless steel square	1 Style 475* , large and small stainless steel square	Style 451, 452, 454, 456, 459, 461, 462, 469, 471 and 481 optionally with stainless steel plinth profile as in style 450 (only on door heights RM 2125 mm and 2250 mm) * Style not available for LPU 67



Style 458, stainless steel hole arc

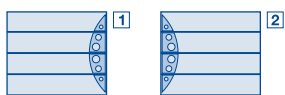

Side door view

Style arrangements (external views correspond to door size 1000 × 2125 mm. Other door sizes may have a different design)

1 Style 450	1 Style 451, 461 ²⁾	1 Style 452, 462 ²⁾	1 Style 453, 463 ²⁾	1 Style 454	1 Style 455
1 Style 456	1 Style 457	2 Style 458	1 Style 459, 469 ²⁾	1 Style 460	
1 Style 471, 481 ²⁾	1 Style 472, 482 ²⁾	1 Style 473, 483 ²⁾	1 Style 474	1 Style 475	Styles 451, 452, 454, 456, 459, 461, 462, 469, 471 and 481 optional with stainless steel plinth profile as in style 450 (only on door in door heights RM 2125 and 2250 mm)

1) Except for doors with wicket door

2) LPU 42 glazing with synthetic double panes clear (DS) or crystal structure (DK) or triple insulated glass pane, clear view 160 × 160 mm, pane thickness 41 mm; LPU 67 synthetic triple pane clear (S3) or crystal structure (U3), clear view 160 × 160 mm, pane thickness 66 mm

Design element

For sectional doors

LPU 42, D-, T- and M-ribbed

View of design inlay elements (can be combined with styles)

Style arrangements (other arrangements on request)

View of sectional door
2500 × 2125

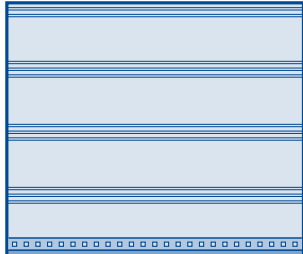

View of sectional door
5000 × 2125

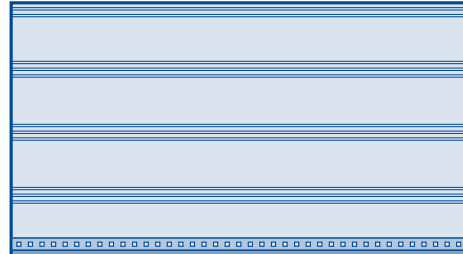

Side door view
1000 × 2125

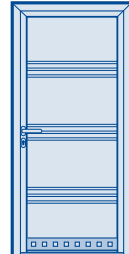

Style 450

With stainless steel plinth profile with / without square perforation
Ordering width:
Up to 3000 mm 1-part
Over 3000 mm 2-part

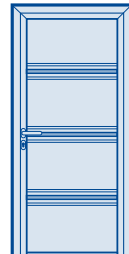
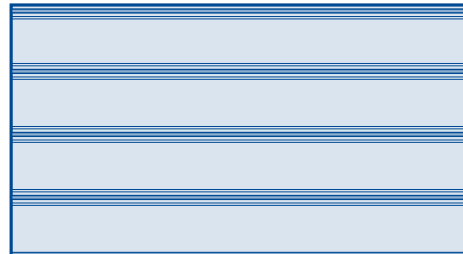
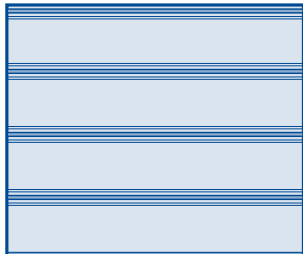

Style 501

With continuous inlays in stainless steel / timber look or RAL to choose



Style 500

With divided inlays (2 × 435 mm) in stainless steel look / timber look or RAL to choose



Style 502

Door with	Inlay lengths					
	Section					
	No. 1	No. 2	No. 3	No. 4	No. 5	No. 6
4 sections	30 %	50 %	73 %	100 %	–	–
5 sections	15 %	30 %	50 %	73 %	100 %	–
6 sections	8 %	15 %	30 %	50 %	73 %	100 %

Available in stainless steel/timber look or RAL to choose



Style 503

LZ	Inlay lengths
≤ 2000	800
> 2000	1000

Available in stainless steel/timber look or RAL to choose

Sectional door LPU 42 with wicket door with trip-free threshold

S- / M- / L-ribbed

Deco-, Sand-, Silk- or Woodgrain

External views

(The dimensions in the illustrations correspond to door height 2125 mm. Deviations may occur with other door heights. Due to the low threshold height, the ground in front of the garage must be level or sloped to guarantee smooth opening of the wicket door (opening outwards) – see page 46.) A rain canopy is provided above the wicket door for doors with wicket door with more than 4 door sections (see page 43).

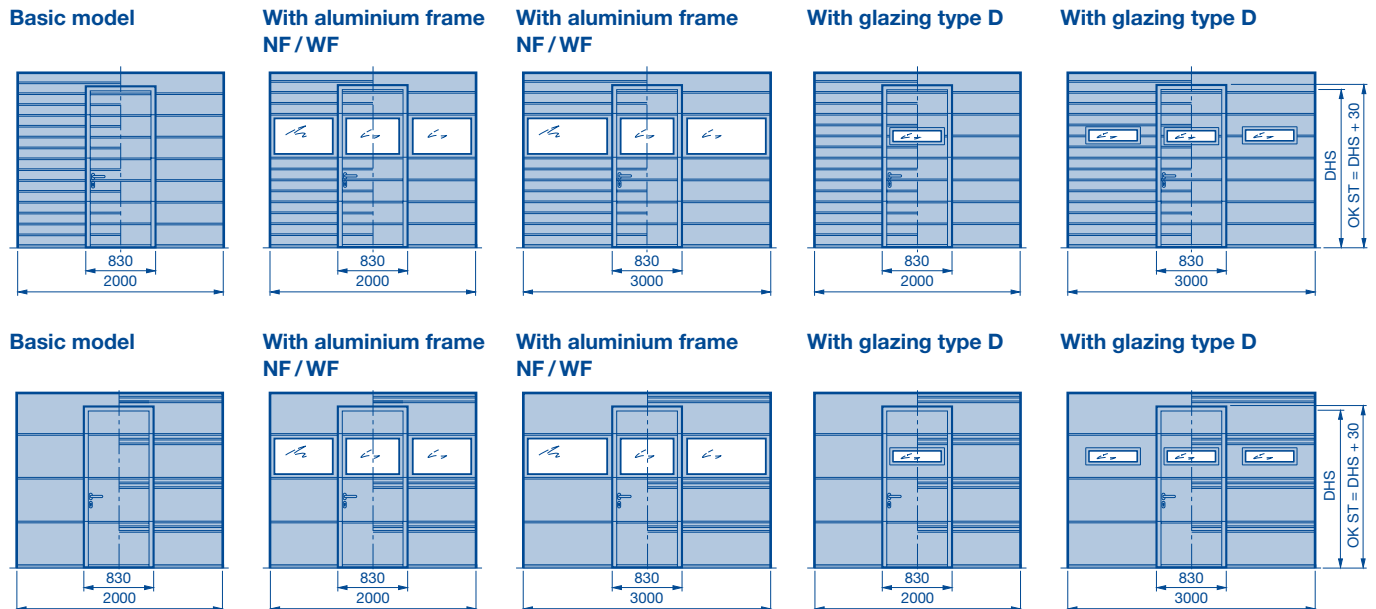

Wicket doors

Wicket doors always consist of 4 parts and, for versions with S-ribbing, are always uniformly divided. The clear passage width of the wicket door is 830 mm and the threshold height starts at 5 mm and increases to 10 mm. Beyond their standard arrangements, wicket doors **without** glazing can be offset to a fixed edge distance of 500 mm.

Special equipment

Ventilation via S- / M- / L-ribbing

- Ventilation grille, ventilation cross section 40 cm² each arrangement

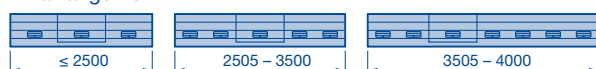

- Aluminium frame with expanded mesh, 58 % ventilation cross section

- Aluminium frame (standard profile NF or profile with thermal break WF)
- Glazing type D, 16 mm
- Panel glazing type S or M, 22 mm
- With wicket doors with multiple-point locking, glazings are only possible above the wicket door (from the 5th section from the bottom)
- With integrated overhead door closer, glazing types S, M, NF and WF are not possible in the 4th wicket door section, only to the right and left of the wicket door (except for wicket door arrangement "a" & "b", here only on request)
- Glazing in the 1st and 2nd section on request
- Design glazings (based on technical feasibility)

Glazing options

Design elements for doors with wicket door

Arrangement and number of elements as well as elements in the wicket door based on technical feasibility. (The dimensions in the illustrations correspond to size 2500 × 2125 mm. Deviations may occur with other sizes.)

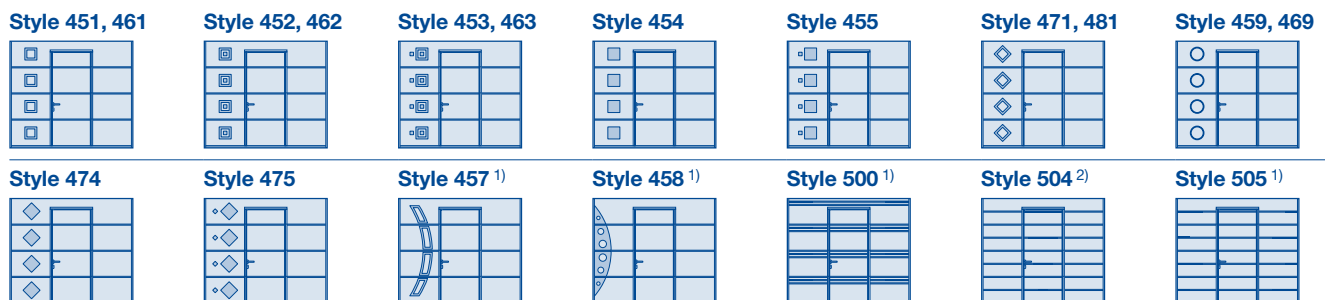

- 1) Only possible on left and/or right next to the wicket door!
- 2) Only possible in the wicket door!

Sectional door LPU 42 with wicket door with trip-free threshold

S- / M- / L-ribbed

Deco-, Sand-, Silk- or Woodgrain

Size range

Door width in 1 mm increments, door height in grid height. Intermediate heights possible from 5 door sections. See track applications for the ceiling height and clear passage (page 36–37, 40). **Please observe the size ranges of the door types.**

		A	B	C	D	DRH							
RM	3000	6	500	1955	1955	831							
	2875	6	479	1871	1871	799							
	2750	5	550	2155	2155	906							
	2625	5	525	2055	2055	868							
	2500	5	500	1955	1955	831							
	2375	5	475	1855	1855	793							
	2250	4	562	2123	2203	924							
	2205	4	550	2075	2155	906							
	2125	4	531	1999	2079	877							
	2080	4	520	1955	2035	861							
	2000	4	500	1875	1955	831							
	1955	4	488	1827	1907	813							
	1875	4	468	1747	1827	782							
			3	5	7	9	No. of ventilation grilles with 40 cm ² ventilation cross section each						
		3	4	5	Number of infills in aluminium frame per door section								
		1	3	4	5	No. of type D, M glazings per door section							
1 → 2370		3	4	5	No. of type S glazings per door section								
		2375	2500	2750	3000	3250	3500	3750	4000	4250	4500	4750	5000
		LZ											

- A** No. of door sections
W Door section height
C Clear passage height of wicket door (DHS)
D Clear passage height of wicket door (DHS) with top glazing type D, S, M
DRH Lever height
RM Grid height
LZ Clear frame dimensions (from 2000)
OK ST Top edge of wicket door = DHS + 30 mm
 → Up to width
 ● Only possible in intermediate heights for Deco-, Sand- and Silkgrain. Intermediate heights from 2875 (for RM 3000) and from 2575 (for RM 2750).

Notes:

- Only track application N or L is possible for sectional doors with wicket door!
- For doors up to RM 2250 and with top glazing type D, S, M, the distance from FFL to the bottom edge of the lintel must be equal to or greater than the ordering size (RM).
- For linkage fitting for multiple-point locking in doors with wicket door with 4 sections, a clearance of 500 mm is required outside above the door (see page 34).

Sectional door LPU 42 with wicket door with trip-free threshold

S- / M- / L-ribbed

Deco-, Sand-, Silk- or Woodgrain

External views (matching for doors with glazing)

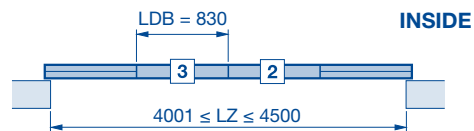
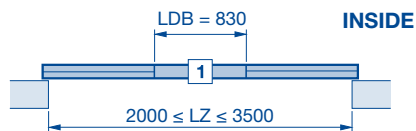

Glazing type D



Glazing type D



Glazing type S



Glazing type S



Glazing type M



Glazing type M



Aluminium frame NF / WF

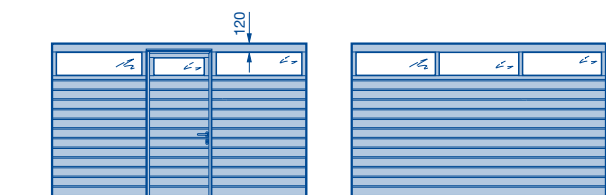

Aluminium frame NF / WF



The dimensions in the illustrations correspond to door height 2125 mm and arrangement 3.

Sectional door LPU 42 with wicket door with trip-free threshold

S-panelled

Deco- or Woodgrain

External views

(The dimensions in the illustrations correspond to size 2500 × 2125 mm. Deviations may occur with other door sizes. Due to the low threshold height, the ground in front of the garage must be level or sloped to guarantee smooth opening of the wicket door (opening outwards) – see page 46.)

A rain canopy is provided above the wicket door on doors with wicket door with more than 4 door sections (see page 43).

Basic model

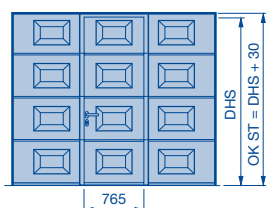

Style S0

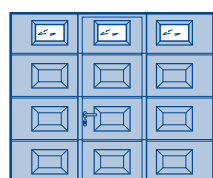

Style S1 with decorative rail (rhombus)

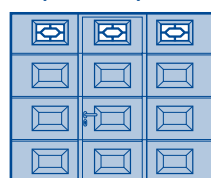

Style S2 with decorative rail (cross)

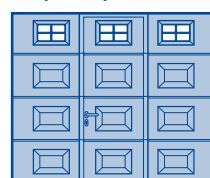

Wicket doors

Wicket doors always consist of 4 parts. The clear passage width of the wicket door is 765 mm and the threshold height starts at 5 mm and increases to 10 mm.

Size range

Door width in 1 mm increments, door height only in grid height. Intermediate heights are not possible. See track applications for the ceiling height and clear passage (page 36–37, 40).

		A	B	C	DrH
RM	3000	6	500	1955	831
	2875	6	479	1871	799
	2750	5	550	2155	906
	2625	5	525	2055	868
	2500	5	500	1955	831
	2375	5	475	1855	793
	2250	4	562	2203	924
	2205	4	550	2155	906
	2125	4	531	2079	877
	2080	4	520	2035	861
	2000	4	500	1955	831
	1955	4	488	1907	813
			Numbers of panels / panel glazings per door section		
		3	4	5	
		2500	2750	3000	3250
		3500	3750	4000	
		LZ			

- A** No. of door sections
- W** Door section height
- C** Clear passage height of wicket door (DHS)
- DrH** Lever height
- RM** Grid height
- LZ** Clear frame dimensions (from 2000 mm)
- OK ST** Top edge of wicket door = DHS + 30 mm
- Up to width
- Grid heights RM not possible with Deco grain

Notes:

- With 4 panels, the wicket door is set off-centre!
- Sectional door with wicket door only possible with track application N or L!
- For doors up to 2250 mm, the distance from FFL to the bottom edge of the lintel must be equal to or greater than the ordering size (RM).
- For linkage fitting for multiple-point locking in doors with wicket door with 4 sections, a clearance of 500 mm is required outside above the door (see page 34).

Special equipment

Glazing options – panel glazing

Clear or crystal structure double panes, 16 mm

- Glazing S0
- Glazing S1
- Glazing S2
- Glazing S10, S20 (see page 18)
- With wicket doors with multiple-point locking, glazings are only possible above the wicket door (from 5th section from the bottom)
- With integrated overhead door closer, glazing type S not possible in the 4th wicket door section (only left and right next to the wicket door)

- Glazing in the 1st and 2nd section on request

Sectional door LPU 42 with wicket door with trip-free threshold

Arrangement of the wicket door

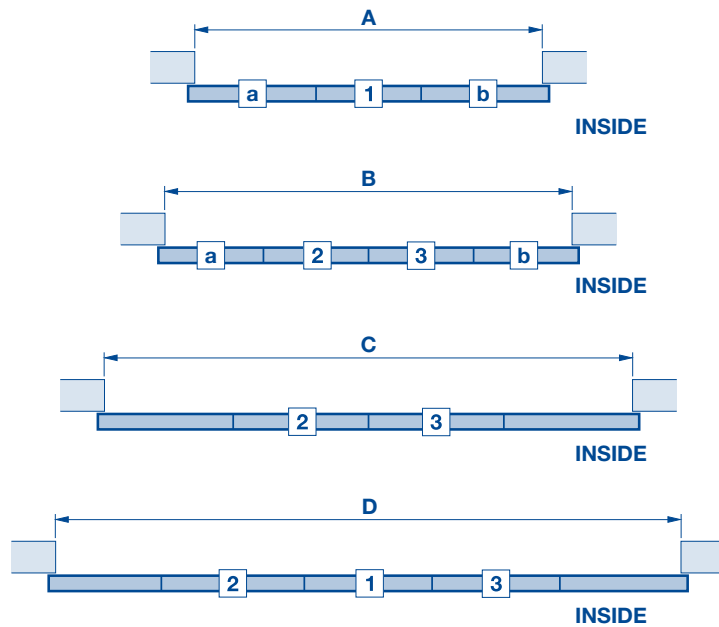

Note:

Arrangement “a” and “b” only for S-, M and L-ribbed versions (glazing possible on request). 500 mm fixed distance from the edge.

Note:

Wicket door only opening outwards.

	A	B	C	D
Sectional door S-, M- or L-ribbed	2000 – 3500	3501 – 4000	4001 – 4500	4501 – 5000
Sectional door, D- or T-ribbed	2000 – 3500	3501 – 4000	4001 – 4500	4501 – 5000
Sectional door, S-panelled	2000 – 2500	2501 – 3250	–	3251 – 4000

Sectional door LPU 42 with wicket door and threshold rail

Double-skinned steel sections

S- / M- / L- / D- / T-ribbed

Deco-, Sand-, Silk- or Woodgrain

External views

(The dimensions in the illustrations correspond to door height 2125 mm. Deviations may occur with other door heights. Due to the low threshold height, the ground in front of the garage must be level or sloped to guarantee smooth opening of the wicket door (opening outwards) – see page 46.)

A rain canopy is provided above the wicket door on doors with wicket door with more than 4 door sections (see page 43).

Basic model

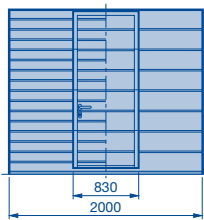

With aluminium frame NF/WF

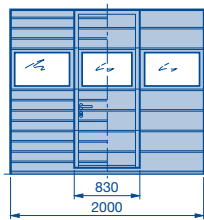

With aluminium frame NF/WF

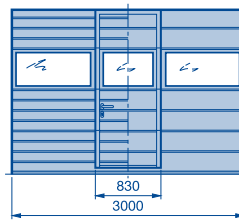

With glazing type D

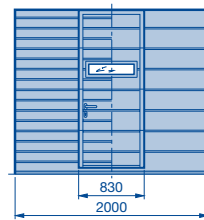

With glazing type D

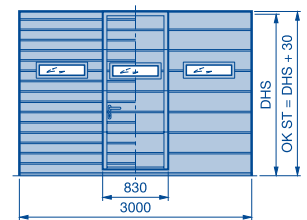

Basic model

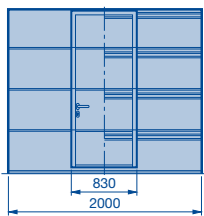

With aluminium frame NF/WF

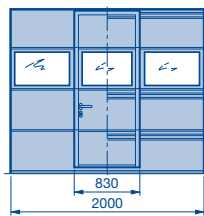

With aluminium frame NF/WF

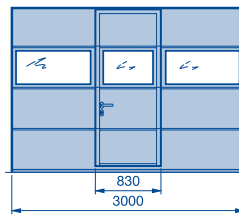

With glazing type D

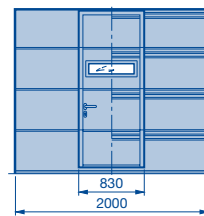

With glazing type D

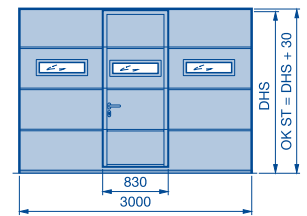

Wicket doors

Wicket doors always consist of 4 parts and, for versions with S-ribbing, are always uniformly divided. The clear passage width of the wicket door is 830 mm, the threshold height is 48 mm (distance from top edge of wicket door to FFL is 38.5 mm).

Size range

Door width in 1 mm increments, door height in grid height. Intermediate heights from 5 door sections on request. See track applications for the ceiling height and clear passage (pages 36-37). **Please observe the size ranges of the door types.**

		A	B	C	D	DrH
RM	3000	6	500	1955	1955	831
	2875	6	479	1871	1871	799
	2750	5	550	2155	2155	906
	2625	5	525	2055	2055	868
	2500	5	500	1955	1955	831
	2375	5	475	1855	1855	793
	2250	4	562	2123	2203	924
	2205	4	550	2075	2155	906
	2125	4	531	1999	2079	877
	2080	4	520	1955	2035	861
	2000	4	500	1875	1955	831
	1955	4	488	1827	1907	813
	1875	4	468	1747	1827	782
	3 → 2500		5	No. of ventilation grilles with 40 cm ² ventilation cross section each		
3		No. of infills in aluminium frame per door section				
1 → 2500		3	No. of type D, M glazings per door section			
1 → 2370		3	No. of type S glazings per door section			
LZ		2375	2500	2750	3000	

- A** No. of door sections
- W** Door section height
- C** Clear passage height of wicket door (DHS)
- D** Clear passage height of wicket door (DHS) with top glazing type D, M, S, stainless steel styles
- DRH** Lever height
- RM** Grid height
- LZ** Clear frame dimensions (from 2000 mm)
- OK ST** Top edge of wicket door = DHS + 30 mm
- Up to width
- Only possible in intermediate heights for Deco-, Sand- and Silkgrain. Intermediate heights from 2875 (for RM 3000) and from 2575 (for RM 2750).

Notes:

- Only track application N or L is possible for sectional doors with wicket door!
- Multiple-point locking for wicket doors not possible.
- Only centre wicket door position possible.

Arrangement of the wicket door

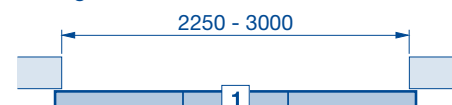

Glazing options

- Aluminium frame (standard profile NF or profile with thermal break WF)
- Glazing type D, 16 mm
- Panel glazing type S or M, 22 mm
- Glazing in the 1st and 2nd section on request

- Glazing possible from the 3rd wicket door section and above the wicket door (from 3rd section from bottom)
- Design glazings (see page 21)
- Design elements (see page 21)
 - Styles
 - Design inlay elements

Sectional door LPU 42 with wicket door and threshold rail

Double-skinned steel sections

S-panelled

Deco- or Woodgrain

External views

(The dimensions in the illustrations correspond to size 2500 × 2125 mm. Deviations may occur with other door sizes. Due to the low threshold height, the ground in front of the garage must be level or sloped to guarantee smooth opening of the wicket door (opening outwards) – see page 46.)

A rain canopy is provided above the wicket door on doors with wicket door with more than 4 door sections (see page 43).

Basic model

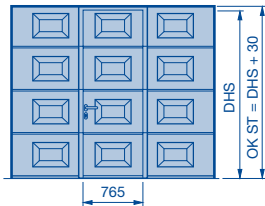

Style S0

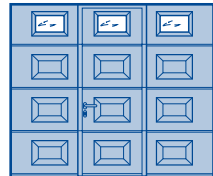

Style S1 with decorative rail (rhombus)

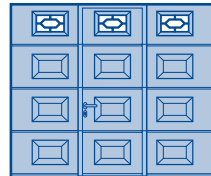

Style S2 with decorative rail (cross)

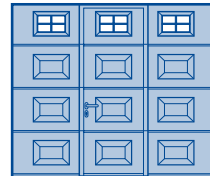

Wicket doors

Wicket doors always consist of 4 parts. The clear passage width of the wicket door is 765 mm, the threshold height is 48 mm (distance from top edge of wicket door to FFL is 38.5 mm).

Size range

Door width in 1 mm increments, door height only in grid height. Intermediate heights are not possible. See track applications for the ceiling height and clear passage (pages 36-37). **Please observe the size ranges of the door types.**

			A	B	C	DrH
RM	3000		6	500	1955	831
	2875	● ●	6	479	1871	799
	2750	● ●	5	550	2155	906
	2625	● ●	5	525	2055	868
	2500		5	500	1955	831
	2375		5	475	1855	793
	2250		4	562	2203	924
	2205	● ●	4	550	2155	906
	2125		4	531	2079	877
	2080	● ●	4	520	2035	861
	2000		4	500	1955	831
	1955	● ●	4	488	1907	813
			3 4	Numbers of panels / panel glazings per door section		

- A** No. of door sections
- W** Door section height
- C** Clear passage height of wicket door (DHS)
- DRH** Lever height
- RM** Grid height
- LZ** Clear frame dimensions (**from 2250 mm**)
- OK ST** Top edge of wicket door = DHS + 30 mm
- Up to width
- Grid heights RM not possible with Decograin

Notes:

- Only track application N or L is possible for sectional doors with wicket door!
- Multiple-point locking for wicket doors not possible.
- Only centre wicket door position possible.

Special equipment

Glazing options – panel glazing

Clear or crystal structure double panes, 16 mm

- Glazing S0
- Glazing S1
- Glazing S2
- Glazing S10, S20 (see page 18)
- Glazing possible from the 3rd wicket door section and above the wicket door (from 3rd section from bottom)
- Glazing in the 1st and 2nd section on request

Arrangement of the wicket door

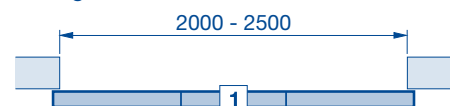

Sectional door LTH 42

S- / M- / L-ribbing, V-panelled

Nordic Pine / Hemlock

External views

(The dimensions shown correspond to size 2500 × 2125 mm. Deviations may occur with other door sizes.)

Basic model S-ribbed



Basic model M-ribbed



Basic model L-ribbed



Basic model V-panelled

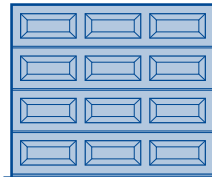

With glazing V0

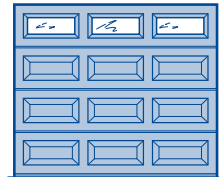

Size range

Door width in 10 mm increments, intermediate heights are possible (on request for S-ribbed versions).

RM	S- / M- / L-ribbed					V-panelled
	A	B	C ₁	C ₂	C ₃	A
3000	6	500	125	250	-	6
2875	6	479	120	239	-	6
2750	5	550	138	275	-	6
2625	5	525	131	262	-	5
2500	5	500	125	250	-	5
2375	5	475	119	237	-	5
2250	4	562	141	281	-	5
2205	4	550	138	275	-	
2125	4	531	133	265	-	4
2080	4	520	130	260	-	
2000	4	500	125	250	-	4
1955	4	488	122	234	-	
1875	4	468	117	234	-	4

		Numbers of panels / panel glazings per door section			
		3	4	5	6
LZ	2250				
	2375				
	2500				
	2750				
	3000				
	3250				
	3500				
	3750				
	4000				
	4250				
	4500				
	4750				
	5000				

Note:
Sectional door LTH 42 only with torsion spring assembly

A No. of door sections
W Door section height
C₁ S-ribbed spacing

C₂ M-ribbed spacing
C₃ L-ribbed spacing
RM Grid height

LZ Clear frame dimensions (from 2000 mm)

Ventilation

- Ventilation slots in bottom seal (standard), ventilation cross section 65 cm² for one metre door width

Glazing options (for panelled versions only)

- Panel glazing with clear or crystal structure, 3 mm

Sectional door LTH 42 with special designs

Nordic Pine / Hemlock

External views

Style 401

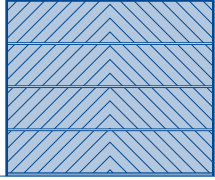

Style 402

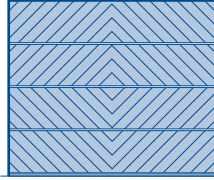

Style 403

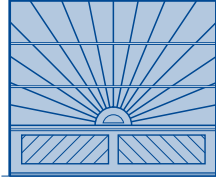

Style 404

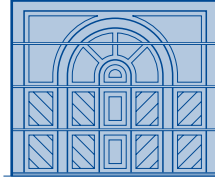

Style 405

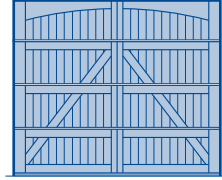

Style 401

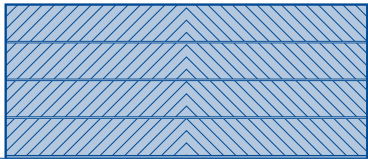

Style 402

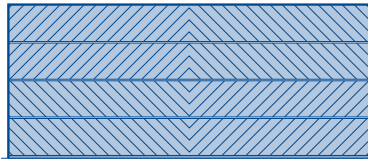

Style 403

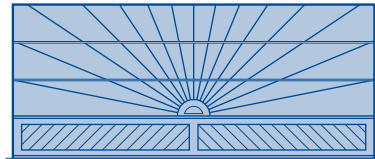

Style 404



Style 405

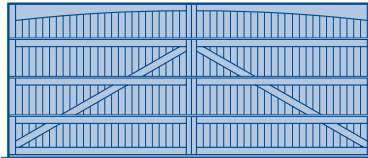

The dimensions in the illustrations correspond to the size 2500 x 2125 mm (top row) as well as the size 5000 x 2125 mm (centre and bottom row). Deviations may occur with other sizes.

Size range

Door width in 10 mm increments, intermediate heights on request. Further designs on request.

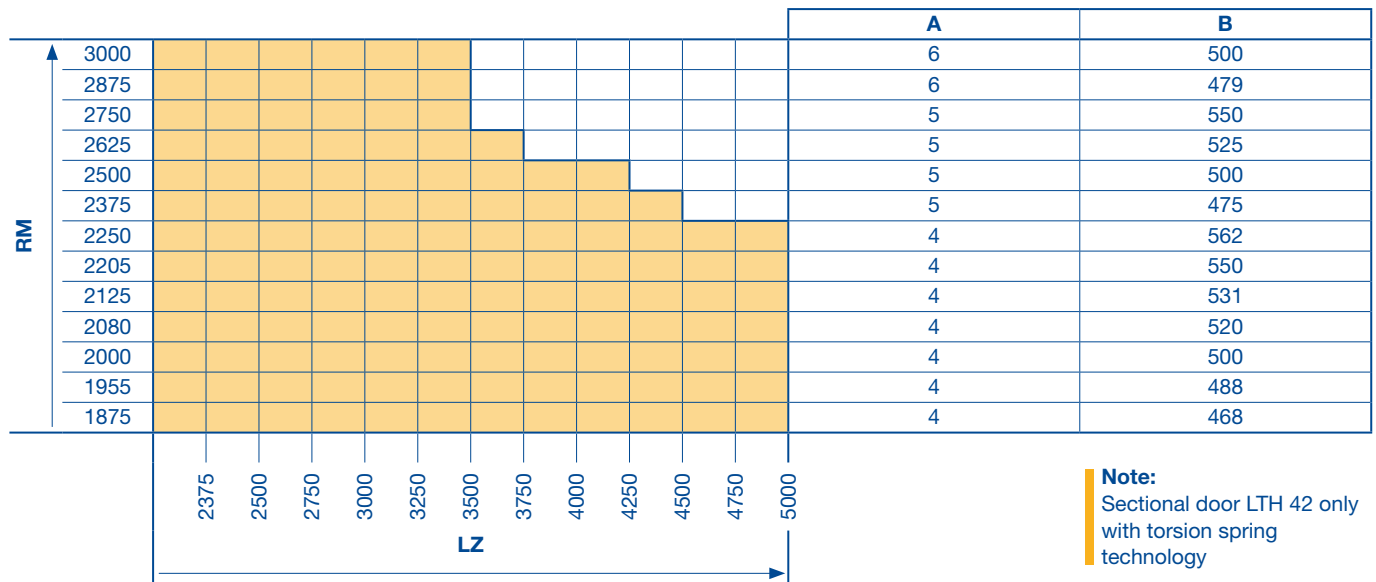

Note: Sectional door LTH 42 only with torsion spring technology

A No. of door sections
W Door section height
RM Grid height

LZ Clear frame dimensions (from 2250 mm)

Ventilation

- Ventilation slots in bottom seal (standard), ventilation cross section 65 cm² for one metre door width

Track application: Z

Z = Tension spring track application

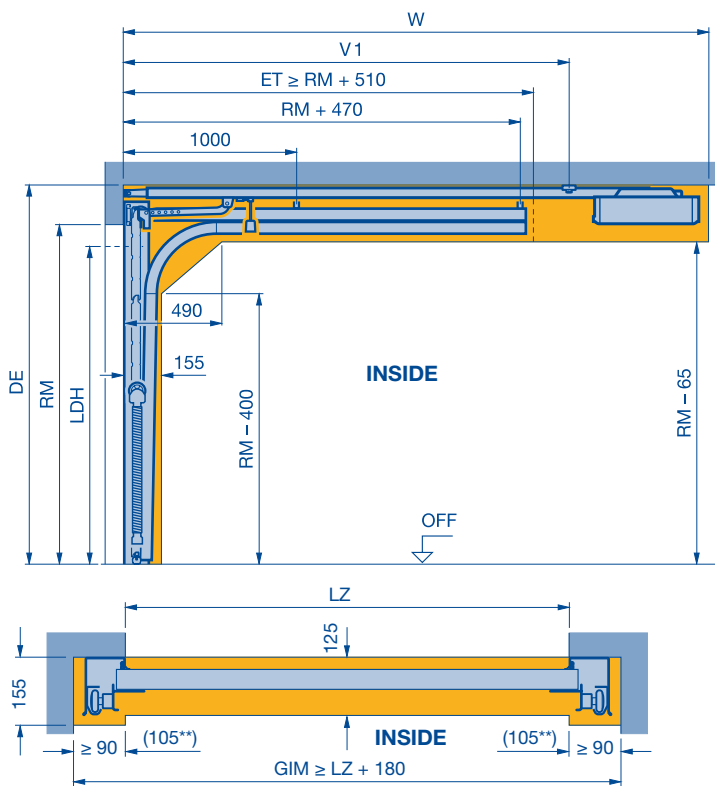

Note:

* Not possible for Silkgrain and LPU 67!

** Clearance required for fitting doors with leading photocell (see page 42).

RM	Manual operation		With operator			
	Min. DE	LDH	Min. DE	Min. DE with ThermoFrame set 1	LDH	LDH (LPU 67 Thermo)
	RM + 100	RM - 80	RM + 115	RM + 145	RM - 30	RM - 55
1875	1975	1795	1990	2020	1845	1820
1955	2055	1875	2070	2100	1925	1900
2000	2100	1920	2115	2145	1970	1945
2080	2180	2000	2195	2225	2050	2025
2125	2225	2045	2240	2270	2095	2070
2205	2305	2125	2320	2350	2175	2150
2250	2350	2170	2365	2395	2220	2195
2375	2475	2295	2490	2520	2345	2320
2500	2600	2420	2615	2645	2470	2445
2625	2725	2545	2740	2765	2595	-

LDH Clear passage height

RM Grid height

LZ Clear frame dimensions

DE Ceiling height

Max. DE standard suspension = RM + 410

Max. DE with track suspension set = RM + 675

ET Distance back

GIM Inside garage dimension

V₁ Rear operator boom suspension

W Total distance back including operator head

Notes:

- The clearance for fitting and subsequent operation of the door must be complied with.
- Increased required headroom for folding roller bracket set (see page 42).
- No additional required headroom for ThermoFrame sets 4–5.
- LPU 67 Thermo not possible with operator ProMatic.
- LPU 67 Thermo not possible with aluminium frames.

ProMatic, SupraMatic E, P and HT	V ₁	W
With short boom (K) up to door height 2125	2775	3200
With medium boom (M) up to door height 2375	3025	3450
With long boom (L) up to door height 3000	3700	4125
With special boom length on request		

Track application: N

N = Normal track application

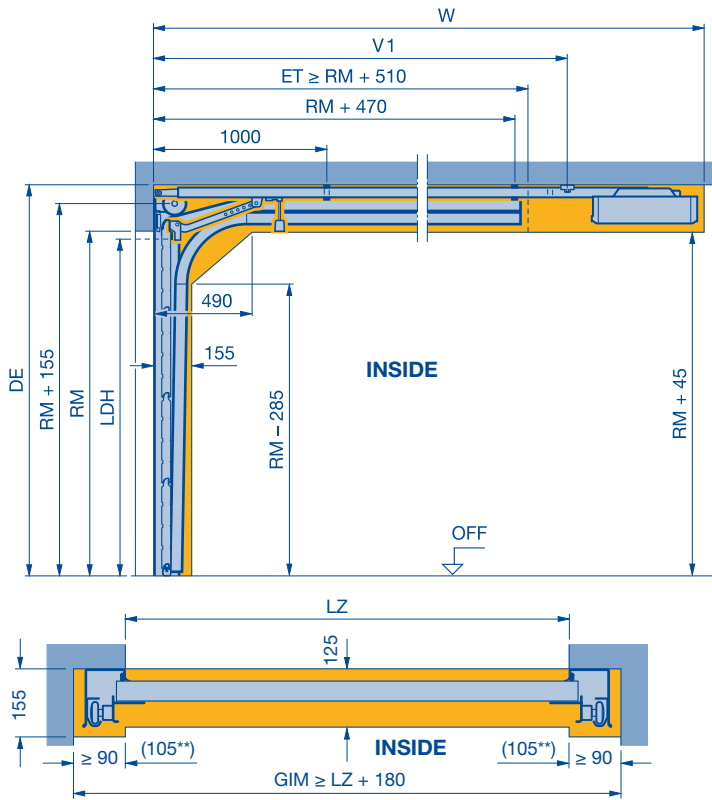

Note:

* For doors under thermal loads, the operator is to be fitted 40 mm higher if applicable (RM + 210 + 40).

** Clearance required for fitting doors with leading photocell (see page 42).

RM	Manual operation		With operator		
	Min. DE	LDH	Min. DE *	Min. DE with ThermoFrame set 1-2, 6, 7, 8, 9	LDH
	RM + 210	RM - 50	RM + 210	RM + 255	RM
1875	2085	1825	2085	2130	1875
1955	2165	1905	2165	2210	1955
2000	2210	1950	2210	2255	2000
2080	2290	2030	2290	2335	2080
2125	2335	2075	2335	2380	2125
2205	2415	2155	2415	2460	2205
2250	2460	2200	2460	2505	2250
2375	2585	2325	2585	2630	2375
2500	2710	2450	2710	2755	2500
2625	2835	2575	2835	2880	2625
2750	2960	2700	2960	3005	2750
2875	3085	2825	3085	3130	2875
3000	3210	2950	3210	3255	3000

LDH Clear passage height

RM Grid height

LZ Clear frame dimensions

DE Ceiling height

Max. DE standard suspension = RM + 520

Max. DE with track suspension set = RM + 795

ET Distance back

GIM Inside garage dimension

V₁ Rear operator boom suspension

W Total distance back including operator head

Notes:

- The clearance for fitting and subsequent operation of the door must be complied with.
- Increased required headroom for folding roller bracket set (see page 42).
- No additional required headroom for ThermoFrame sets 4-5.
- LPU 67 Thermo not possible with operator ProMatic.

ProMatic, SupraMatic E, P and HT	LPU 42	LPU 67	V ₁	W
With short boom (K) up to door height 2250	2250	2125	2775	3200
With medium boom (M) up to door height 2500	2500	2375	3025	3450
With long boom (L) up to door height 3000	3000	3000	3700	4125
With special boom length on request				

Track application: L

L = Low headroom track application

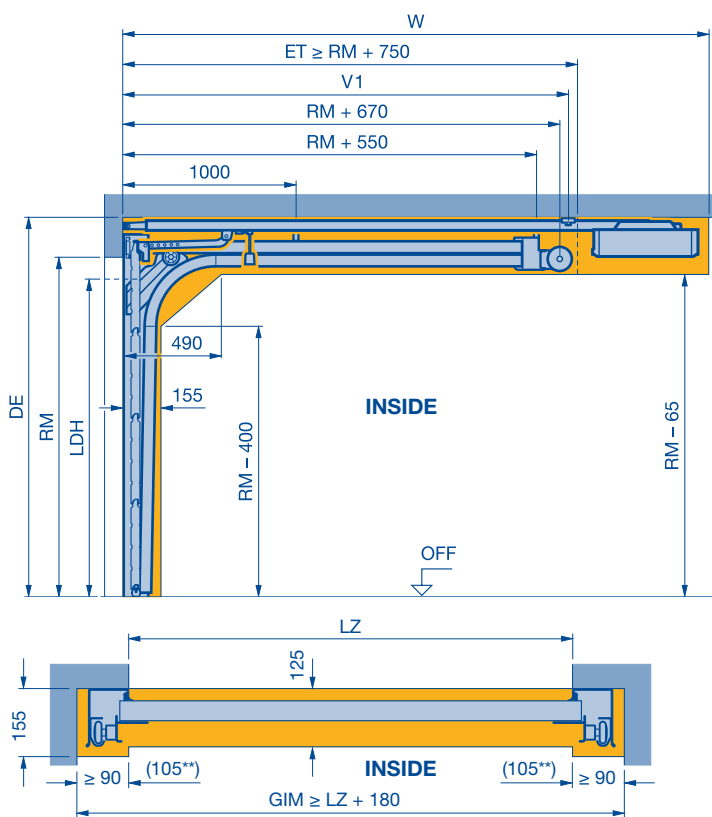

Note:

* For doors under thermal loads, the operator is to be fitted 40 mm higher if applicable (RM + 115 + 40).

** Clearance required for fitting doors with leading photocell (see page 42).

RM	Manual operation		With operator			
	Min. DE	LDH	Min. DE*	Min. DE with Thermo-Frame sets 1-2, 6, 7, 8, 9	LPU 42	
					LDH Up to LZ = 3000 mm	LDH From LZ = 3010 mm
RM + 100	RM - 100	RM + 115	RM + 145	RM - 30	RM - 80	
1875	1975	1775	1990	2020	1845	1795
1955	2055	1855	2070	2100	1925	1875
2000	2100	1900	2115	2145	1970	1920
2080	2180	1980	2195	2225	2050	2000
2125	2225	2025	2240	2270	2095	2045
2205	2305	2105	2320	2350	2175	2125
2250	2350	2150	2365	2395	2220	2170
2375	2475	2275	2490	2520	2345	2295
2500	2600	2400	2615	2645	2470	2420
2625	2725	2525	2740	2790	2595	2545
2750	2850	2650	2865	2895	2720	2670
2875	2975	2775	2990	3020	2845	2795
3000	3100	2900	3115	3145	2970	2920

RM	LPU 67 Thermo with operator	
	LDH Up to LZ = 3000 mm	LDH From LZ = 3010 mm
	RM - 55	RM - 105
1875	1820	1770
1955	1900	1850
2000	1945	1895
2080	2025	1975
2125	2070	2020
2205	2150	2100
2250	2195	2145
2375	2320	2270
2500	2445	2395
2625	-	-
2750	2695	2645
2875	-	-
3000	2945	2895

- LDH** Clear passage height
- RM** Grid height
- LZ** Clear frame dimensions
- DE** Ceiling height
 - Max. DE standard suspension = RM + 410
 - Max. DE with track suspension set = RM + 675
- ET** Distance back
- GIM** Inside garage dimension
- V₁** Rear operator boom suspension
- W** Total distance back including operator head

Notes:

- The clearance for fitting and subsequent operation of the door must be complied with.
- Increased required headroom for folding roller bracket set (see page 42).
- For DE > RM + 285 an additional 120 × 60 extrusion is required to strengthen the suspension construction in the area of the torsion springs.
- No additional required headroom for ThermoFrame sets 4-5.
- LPU 67 Thermo not possible with operator ProMatic.

ProMatic, SupraMatic E, P and HT	V ₁	W
With short boom (K) up to door height 2125	2775	3200
With medium boom (M) up to door height 2375	3025	3450
With long boom (L) up to door height 3000	3700	4125
With special boom length on request		

Track Applications: H

H = High-lift track application

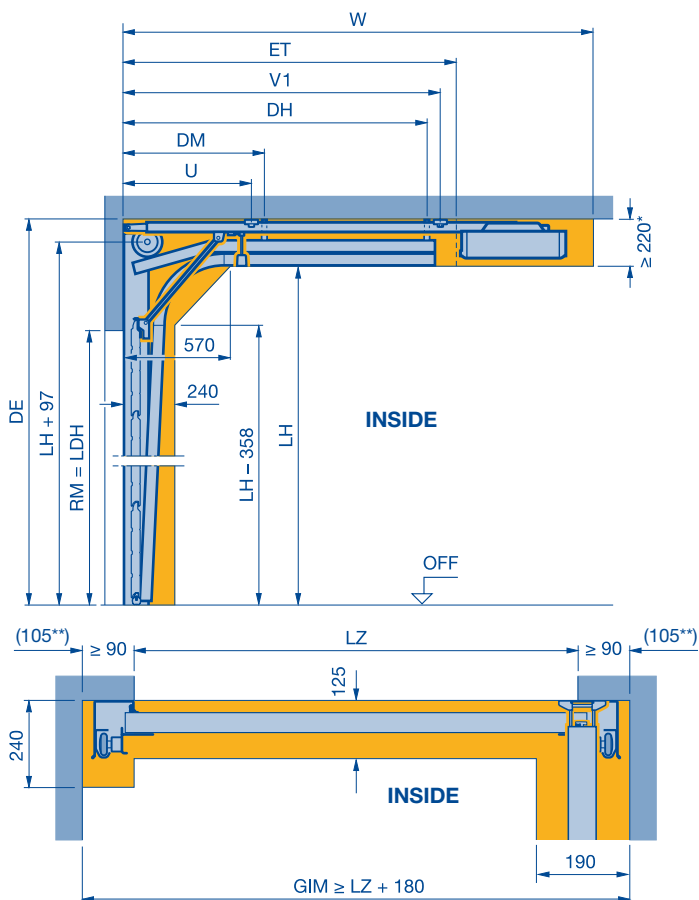

Note:

* with ThermoFrame ≥ 255

** Clearance required for fitting doors with leading photocell (see page 42).

Version without wicket door

RM	Track height			
	(1) with spring buffer		(2) with buffer stop	
	Min.	Max.	Min.	Max.
1875	2260	2634	2635	3190
1955	2340	2714	2715	3270
2000	2385	2759	2760	3315
2080	2465	2839	2840	3395
2125	2510	2884	2885	3440
2205	2590	2964	2965	3520
2250	2635	3009	3010	3565
2375	2760	3134	3135	3690
2500	2885	3259	3260	3815
2625	3010	3384	3385	3940
2750	3135	3509	3510	4065
2875	3315	3634	3635	4190
3000	3565	3759	3760	4315

- LDH** Clear passage height
- RM** Grid height
- LF** Structural opening
- LH** Track height
- LZ** Clear frame dimensions
- DE** Ceiling height
 - Max. DE standard suspension = $LH + 450$
 - Max. DE with track suspension set = $LH + 725$
- DH** Rear ceiling anchor = $ET - 200$
- DM** Centre ceiling anchor = $DH / 2$
- ET** Distance back
 - (1) = $2 \times RM + 690 - LH$
 - (2) = $2 \times RM + 490 - LH$
- GIM** Inside garage dimension
- U** Front operator boom suspension
- V₁** Rear operator boom suspension
- W** Total distance back including operator head

Notes:

- The clearance for fitting and subsequent operation of the door must be complied with.
- Not possible as LPU 67 Thermo.

SupraMatic E, P and HT	U	V ₁	W	Length of operator boom
With short boom (K) up to door height 2125	1100	2775	3200	3000
With medium boom (M) up to door height 2375	1100	3025	3450	3250
With long boom (L) up to door height 3000	1300	3700	4125	3925
With special boom length on request				

Size range for LPU 42 with Deco-, Sand- and Woodgrain surface

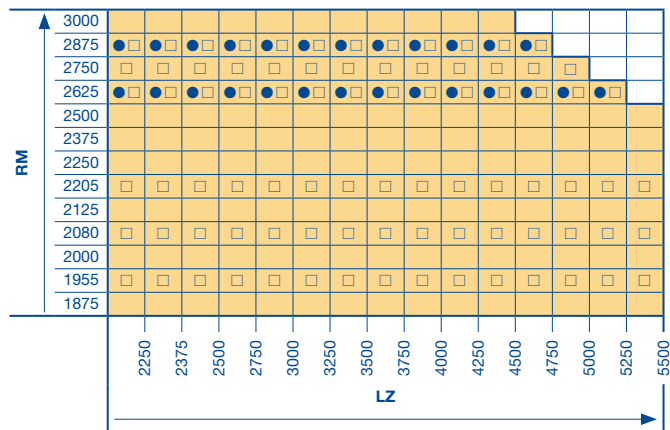

- Grid heights RM not possible with Deco-, Sand- and Silkgrain
- Grid heights RM not possible with Deco-, S-pannelled

Size range for LPU 42 with Silkgrain surface

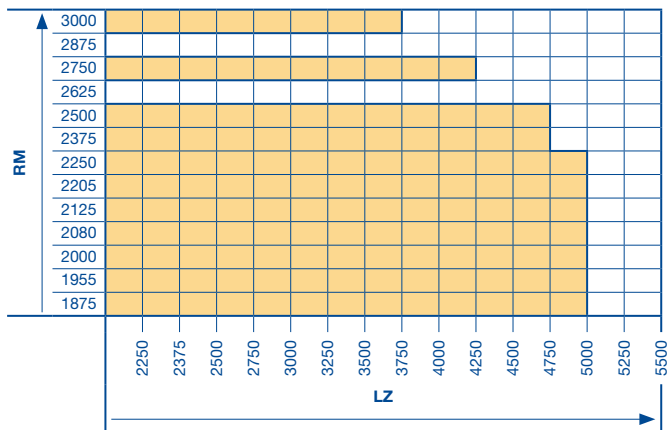

Track application: N

(LPU 42) wicket door with trip-free threshold

N = Normal track application

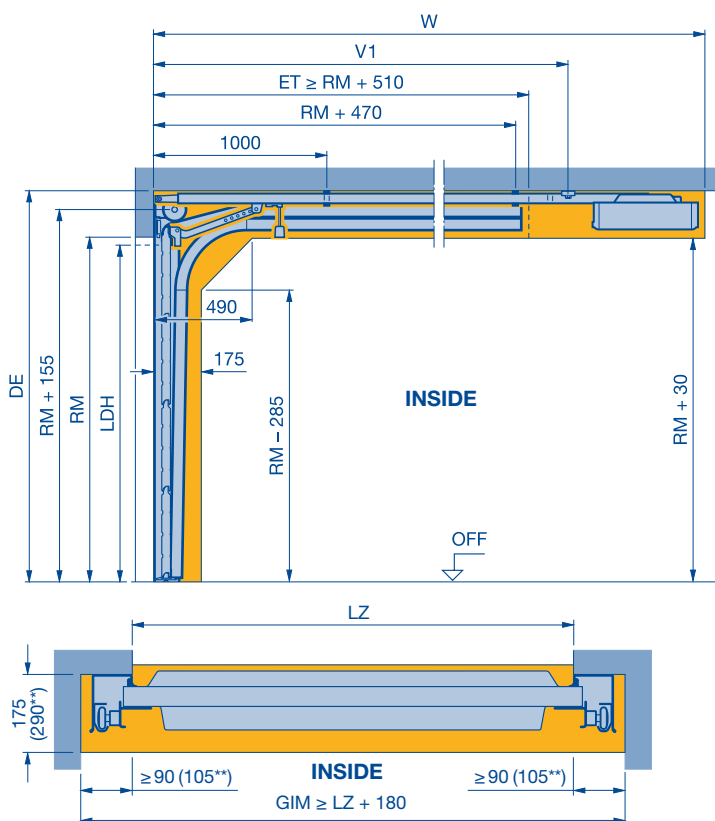

RM	Manual operation		With operator		
	Min. DE	LDH	Min. DE*	Min. DE with ThermoFrame sets 1-2	LDH
	RM + 220	RM - 160	RM + 235	RM + 255	RM - 100
1875	2095	1715	2110	2130	1775
1955	2175	1795	2190	2210	1855
2000	2220	1840	2235	2255	1900
2080	2300	1920	2315	2335	1980
2125	2345	1965	2360	2380	2025
2205	2425	2045	2440	2460	2105
2250	2470	2090	2485	2505	2150
2375	2595	2215	2610	2630	2275
2500	2720	2340	2735	2755	2400
2625	2845	2465	2860	2880	2525
2750	2970	2590	2985	3005	2650
2875	3095	2715	3110	3130	2775
3000	3220	2840	3235	3255	2900

- LDH** Clear passage height
RM Grid height
LZ Clear frame dimensions
DE Ceiling height
 Max. DE standard suspension = RM + 520
 Max. DE with track suspension set = RM + 795
ET Distance back
GIM Inside garage dimension
V₁ Rear operator boom suspension
W Total distance back including operator head

Notes:

- The clearance for fitting and subsequent operation of the door must be complied with.
- Due to the low threshold height, the ground in front of the garage must be level or sloped to guarantee smooth opening of the wicket door (opening outwards) – see page 46.
- For doors up to RM 2250 mm in S-panelled versions or in S-, M- or L-ribbed versions and with top glazing type D, S and M, the distance from FFL to the bottom edge of the lintel must be equal to or greater than the ordering size (RM). Deviating sizes on request!
- Not possible as LPU 67 Thermo.

Notes:

- * For doors under thermal loads, the operator is to be fitted 40 mm higher if applicable (RM + 235 + 40).
- ** Clearance required for fitting doors with leading photocell (see page 42).

SupraMatic P and HT	V ₁	W
With short boom (K) up to door height 2250	2775	3200
With medium boom (M) up to door height 2500	3025	3450
With long boom (L) up to door height 3000	3700	4125
With special boom length on request		

Clearance required for fitting the multiple-point locking linking rods

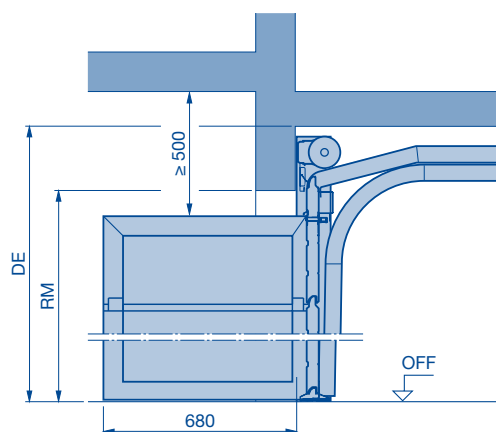

Track application: L

(LPU 42) wicket door with trip-free threshold

L = Low headroom track application

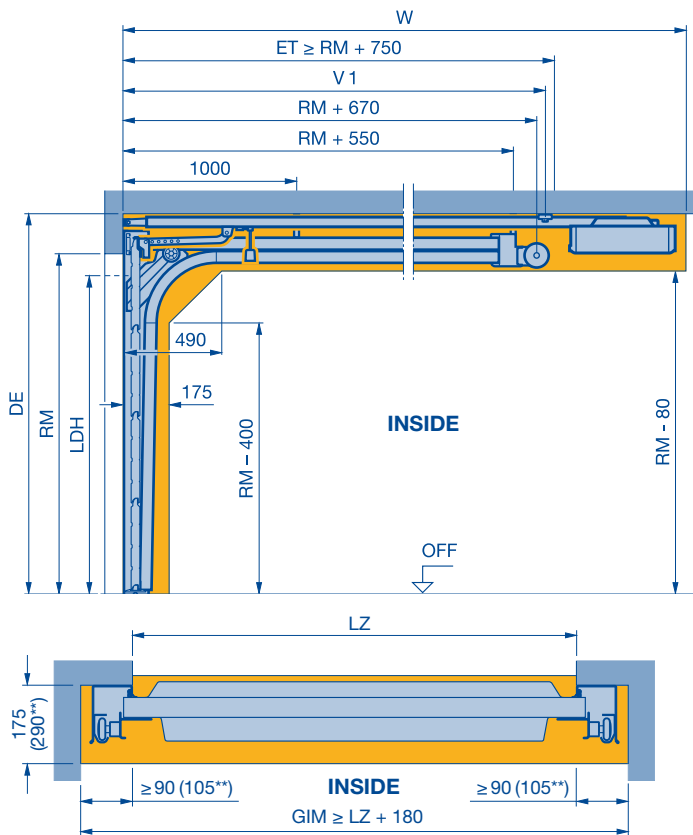

Notes:

* For doors under thermal loads, the operator is to be fitted 40 mm higher if applicable (RM + 125 + 40).

** Clearance required for fitting doors with leading photocell (see page 42).

RM	Manual operation		With operator		
	Min. DE	LDH	Min. DE*	Min. DE with ThermoFrame sets 1-2	LDH
	RM + 125	RM - 160	RM + 125	RM + 145	RM - 160
1875*	2000	1715	2000	2020	1715
1955	2080	1795	2080	2100	1795
2000	2125	1840	2125	2145	1840
2080	2205	1920	2205	2225	1920
2125	2250	1965	2250	2270	1965
2205	2330	2045	2330	2350	2045
2250	2375	2090	2375	2395	2090
2375	2500	2215	2500	2520	2215
2500	2625	2340	2625	2645	2340
2625	2750	2465	2750	2770	2465
2750	2875	2590	2875	2895	2590
2875	3000	2715	3000	3020	2715
3000	3125	2840	3125	3145	2840

* These versions are only available for S- / M- / L-ribbed doors

- LDH** Clear passage height
- RM** Grid height
- LZ** Clear frame dimensions
- DE** Ceiling height
 - Max. DE standard suspension = RM + 410
 - Max. DE with track suspension set = RM + 675 mm
- ET** Distance back
- GIM** Inside garage dimension
- V₁** Rear operator boom suspension
- W** Total distance back including operator head

Notes:

- The clearance for fitting and subsequent operation of the door must be complied with.
- Due to the low threshold height, the ground in front of the garage must be level or sloped to guarantee smooth opening of the wicket door (opening outwards) – see page 46.
- For doors up to RM 2250 in S-panelled versions or in S-, M- or L-ribbed versions and with top glazing type D, S and M, the distance from FFL to the bottom edge of the lintel must be equal to or greater than the ordering size (RM). Deviating sizes on request!
- For DE > RM + 285 mm an additional 120 × 60 mm extrusion is required to strengthen the suspension construction in the area of the torsion springs.
- Not possible as LPU 67 Thermo.

SupraMatic P and HT	V ₁	W
With short boom (K) up to door height 2125	2775	3200
With medium boom (M) up to door height 2375	3025	3450
With long boom (L) up to door height 3000	3700	4125
With special boom length on request		

Track application: N

(LPU 42) wicket door with threshold rail

N = Normal track application

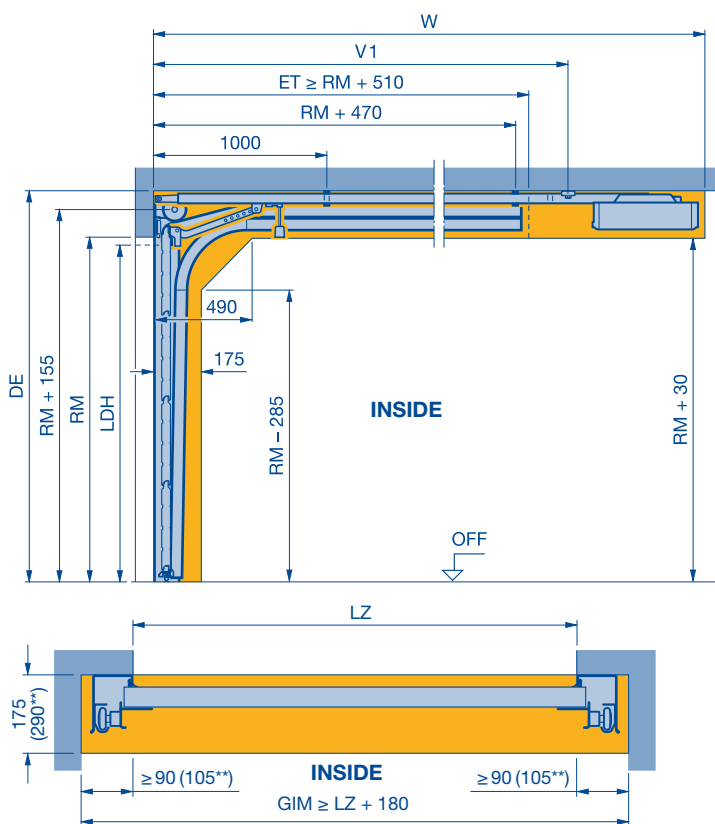

Notes:

* For doors under thermal loads, the operator is to be fitted 40 mm higher if applicable (RM + 235 + 40).

** Clearance required for fitting doors with leading photocell (see page 42).

RM	Manual operation		With operator		
	Min. DE	LDH	Min. DE*	Min. DE with Thermo-Frame sets 1-2	LDH
	RM + 220	RM - 100	RM + 235	RM + 255	RM - 70
1875	2095	1775	2110	2130	1805
1955	2175	1855	2190	2210	1885
2000	2220	1900	2235	2255	1930
2080	2300	1980	2315	2335	2010
2125	2345	2025	2360	2380	2055
2205	2425	2105	2440	2460	2135
2250	2470	2150	2485	2505	2180
2375	2595	2275	2610	2630	2305
2500	2720	2400	2735	2755	2430
2625	2845	2525	2860	2880	2555
2750	2970	2650	2985	3005	2680
2875	3095	2775	3110	3130	2805
3000	3220	2900	3235	3255	2930

LDH Clear passage height

RM Grid height

LZ Clear frame dimensions

DE Ceiling height

Max. DE standard suspension = RM + 520

Max. DE with track suspension set = RM + 795

ET Distance back

GIM Inside garage dimension

V₁ Rear operator boom suspension

W Total distance back including operator head

Notes:

- The clearance for fitting and subsequent operation of the door must be complied with.
- Due to the low threshold height, the ground in front of the garage must be level or sloped to guarantee smooth opening of the wicket door (opening outwards) – see page 46.
- For doors up to RM 2250 mm in S-panelled versions or in S-, M- or L-ribbed versions and with top glazing type D, S and M, the distance from FFL to the bottom edge of the lintel must be equal to or greater than the ordering size (RM). Deviating sizes on request!
- Not possible as LPU 67 Thermo.

SupraMatic P and HT	V ₁	W
With short boom (K) up to door height 2250	2775	3200
With medium boom (M) up to door height 2500	3025	3450
With long boom (L) up to door height 3000	3700	4125
With special boom length on request		

Track application: L

(LPU 42) wicket door with threshold rail

L = Low headroom track application

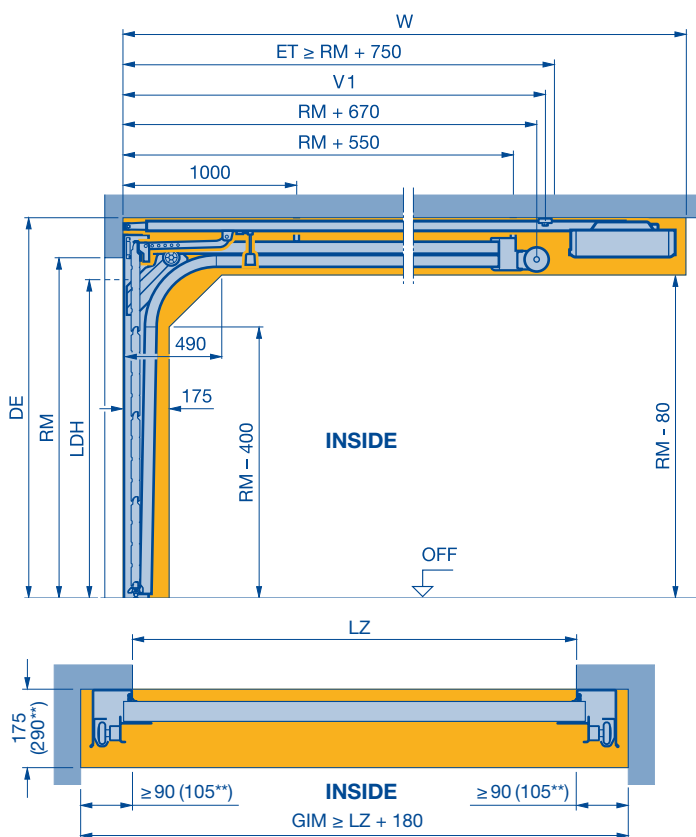

Notes:

* For doors under thermal loads, the operator is to be fitted 40 mm higher if applicable (RM + 125 + 40).

** Clearance required for fitting doors with leading photocell (see page 42).

RM	Manual operation		With operator		
	Min. DE	LDH	Min. DE*	Min. DE with Thermo-Frame sets 1-2	LDH
	RM + 125	RM - 150	RM + 125	RM + 145	RM - 120
1875*	2000	1725	2000	2020	1755
1955	2080	1805	2080	2100	1835
2000	2125	1850	2125	2145	1880
2080	2205	1930	2205	2225	1960
2125	2250	1975	2250	2270	2005
2205	2330	2055	2330	2350	2285
2250	2375	2100	2375	2395	2130
2375	2500	2225	2500	2520	2255
2500	2625	2350	2625	2645	2380
2625	2750	2475	2750	2770	2505
2750	2875	2600	2875	2895	2630
2875	3000	2725	3000	3020	2755
3000	3125	2850	3125	3145	2880

* These versions are only available for S/L-ribbed doors

LDH Clear passage height

RM Grid height

LZ Clear frame dimensions

DE Ceiling height

Max. DE standard suspension = RM + 410

Max. DE with track suspension set = RM + 675 mm

ET Distance back

GIM Inside garage dimension

V₁ Rear operator boom suspension

W Total distance back including operator head

Notes:

- The clearance for fitting and subsequent operation of the door must be complied with.
- Due to the low threshold height, the ground in front of the garage must be level or sloped to guarantee smooth opening of the wicket door (opening outwards) – see page 46.
- For doors up to RM 2250 in S-panelled versions or in S-, M- or L-ribbed versions and with top glazing type D, S and M, the distance from FFL to the bottom edge of the lintel must be equal to or greater than the ordering size (RM). Deviating sizes on request!
- For DE > RM + 285 an additional 120 x 60 extrusion is required to strengthen the suspension construction in the area of the torsion springs.
- Not possible as LPU 67 Thermo.

SupraMatic P and HT	V ₁	W
With short boom (K) up to door height 2125	2775	3200
With medium boom (M) up to door height 2375	3025	3450
With long boom (L) up to door height 3000	3700	4125
With special boom length on request		

Track application: BZ

BZ = Tension spring track application with flush-fitting panels

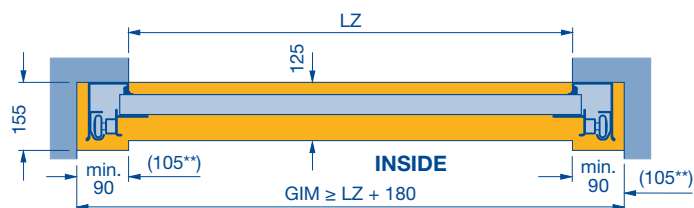
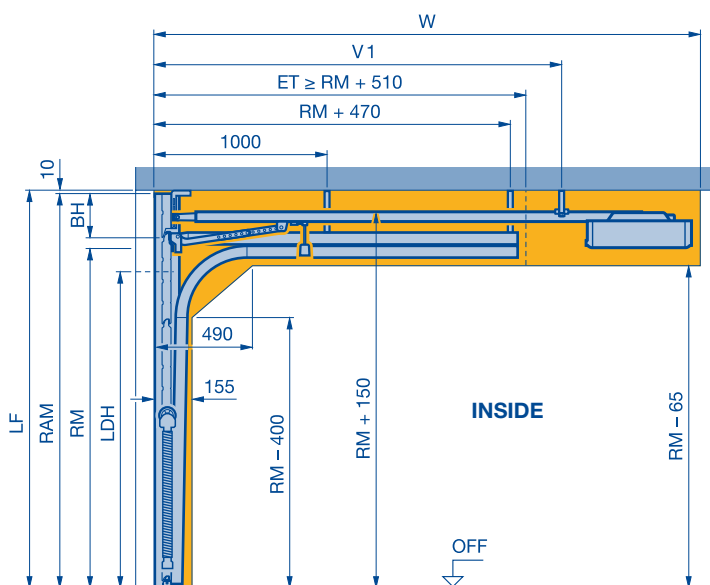

Notes:

* Not possible for Silkgrain!

** Clearance required for fitting doors with leading photocell (see page 42).

RM	RAM		Manual operation	With operator
	Min. RM + 190	max.	LDH RM - 80	LDH RM - 30
1875	2065	2360	1795	1845
1955	2145	2460	1875	1925
2000	2190	2520	1920	1970
2080	2270	2620	2000	2050
2125	2375	2675	2045	2095
2205	2395	2770	2125	2175
2250	2440	2830	2170	2220
2375	2565	2870	2295	2345
2500	2690	3020	2420	2470
2625	2815	3170	2545	2595

LDH Clear passage height	BH Panel height
RM Grid height	RAM Overall frame dimension = ordering size
LZ Clear frame dimensions	Min. RAM = RM + 190
DE Ceiling height	Max. RAM = 3170
Max. DE standard suspension = LH + 410	LF Structural opening
Max. DE with track suspension set = LH + 555	V₁ Rear operator boom suspension
ET Distance back	W Total distance back including operator head
GIM Inside garage dimension	

Notes:

- Not possible with ThermoFrame sets 1 – 3.
- The clearance for fitting and subsequent operation of the door must be complied with.
- Shortening the top door section or aluminium frame is not possible.
- Intermediate sizes possible, shortened from bottom.
- Not possible as LPU 67 Thermo.

ProMatic, SupraMatic E, P and HT	V ₁	W
With short boom (K) up to door height 2125	2847	3272
With medium boom (M) up to door height 2375	3097	3522
With long boom (L) up to door height 3000	3772	4197
With special boom length on request		

Clearance for lintel fitting with flush-fitting panel

Without lintel

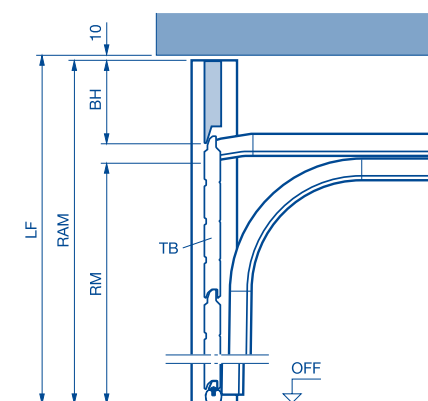

With lintel

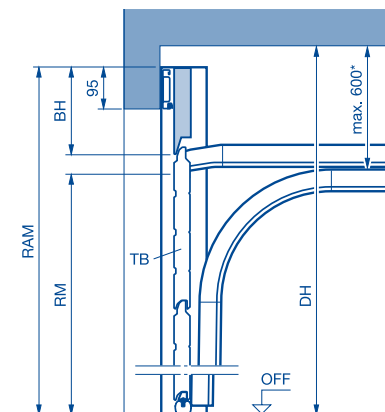

Track application	Panel version
BZ and BL	PU fascia, S-, M- and L-ribbed
	S-panelled on request

RAM LF - 10 mm

DH Ceiling height
RAM Bottom edge of lintel + 95 mm
TB Door leaf
* Suspension
Max. DE standard suspension = RM + 410
Max. DE with track suspension set = RM + 600

Track application: BL

BL = Low headroom track application with flush-fitting panel

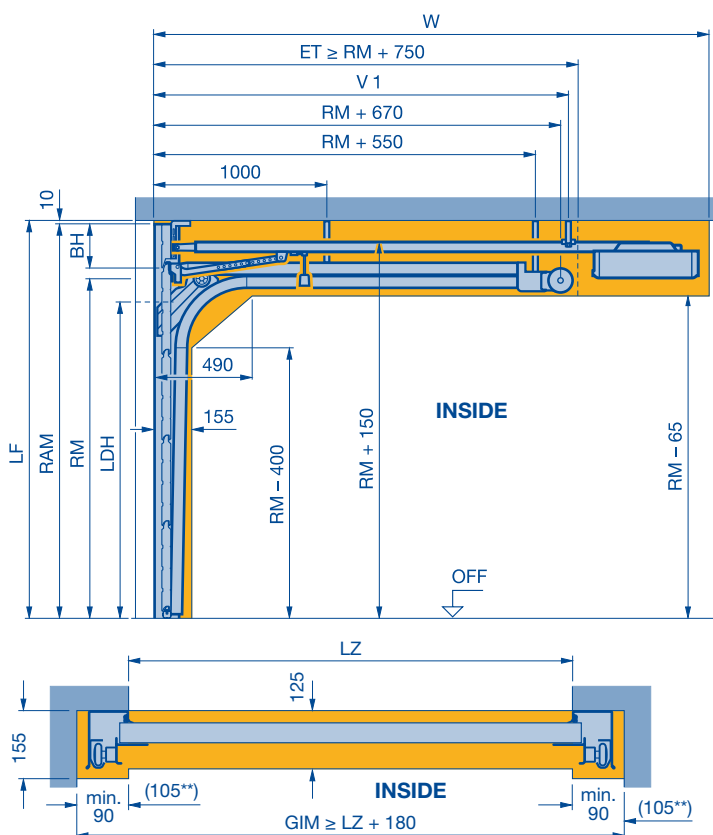

RM	RAM		Manual operation	With operator	
	Min.	max.	LDH	LDH up to LZ ≤ 3000	LDH from LZ ≥ 3010
	RM + 190		RM - 100	RM - 30	RM - 80
1875	2065	2360	1775	1845	1795
1955	2145	2460	1855	1925	1875
2000	2190	2520	1900	1970	1920
2080	2270	2620	1980	2050	2000
2125	2315	2675	2025	2095	2045
2205	2395	2770	2105	2175	2125
2250	2440	2830	2150	2220	2170
2375	2565	2870	2275	2345	2295
2500	2690	3020	2400	2470	2420
2625	2815	3170	2525	2595	2545
2750	2940	3320	2650	2720	2670
2875	3065	3373	2775	2845	2795
3000	3190	3520	2900	2970	2920

- LDH** Clear passage height
- RM** Grid height
- LZ** Clear frame dimensions
- DE** Ceiling height
- Max. DE standard suspension = RM + 410
- Max. DE with track suspension set = RM + 555
- ET** Distance back
- GIM** Inside garage dimension
- BH** Panel height
- RAM** Overall frame dimension = ordering size
- Min. RAM = RM + 190
- Max. RAM = 3520
- LF** Structural opening
- V₁** Rear operator boom suspension
- W** Total distance back including operator head

Notes:

** Clearance required for fitting doors with leading photocell (see page 42).

Notes:

- Not possible with ThermoFrame sets 1 – 3.
- The clearance for fitting and subsequent operation of the door must be complied with.
- Shortening the top door section or aluminium frame is not possible.
- Intermediate sizes possible, shortened from bottom.
- Not possible as LPU 67 Thermo.

ProMatic, SupraMatic E, P and HT	V ₁	W
With short boom (K) up to door height 2125	2847	3272
With medium boom (M) up to door height 2375	3097	3522
With long boom (L) up to door height 3000	3772	4197
With special boom length on request		

Clearance for lintel fitting with flush-fitting panel

Without lintel

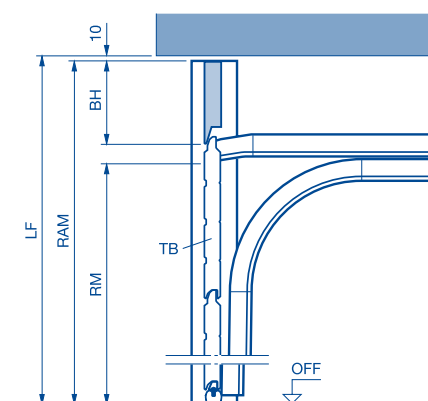

With lintel

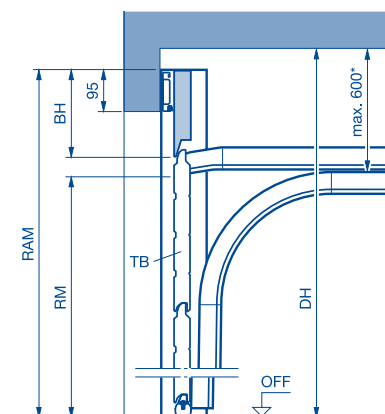

Track application	Panel version
BZ and BL	PU fascia, S-, M- and L-ribbed
	S-panelled on request

RAM LF - 10 mm

- DH** Ceiling height
- RAM** Bottom edge of lintel + 95 mm
- TB** Door leaf
- * Suspension = max. DE standard suspension = RM + 410
- Max. DE with track suspension set = RM + 600

Track application: BL

(LPU 42) wicket door with trip-free threshold

BL = Low headroom track application with flush-fitting panel

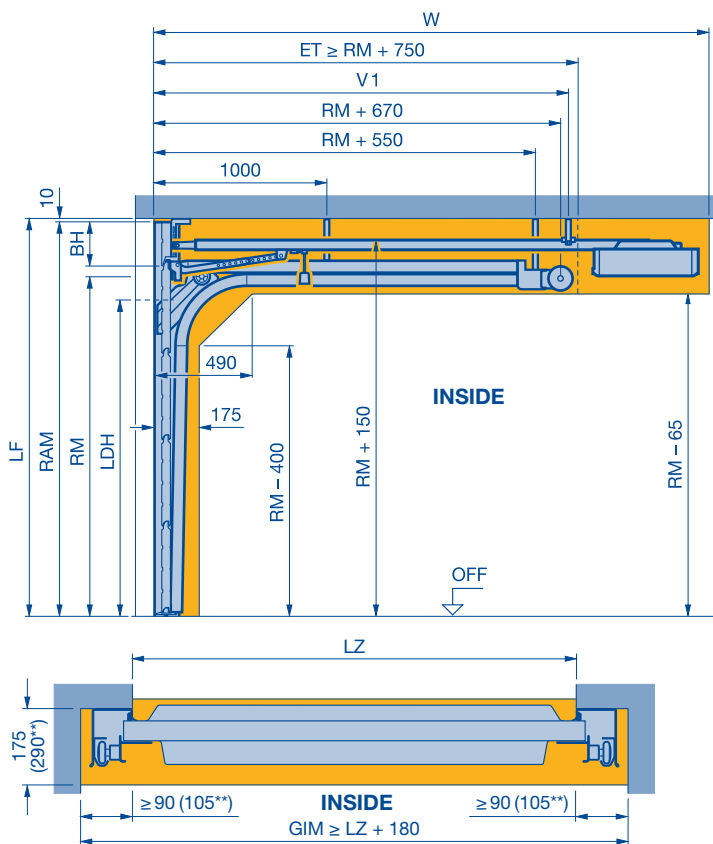

RM	RAM		Manual operation	With operator
	Min. RM + 190	max.	LDH RM - 160	LDH RM - 160
1875	2065	2360	1715	1715
1955	2145	2460	1795	1795
2000	2190	2520	1840	1840
2080	2270	2620	1920	1920
2125	2315	2675	1965	1965
2205	2395	2770	2045	2045
2250	2440	2830	2090	2090
2375	2565	2870	2215	2215
2500	2690	3020	2340	2340
2625	2815	3170	2465	2465
2750	2940	3320	2590	2590
2875	3065	3373	2715	2715
3000	3190	3520	2840	2840

- LDH** Clear passage height
- RM** Grid height
- LZ** Clear frame dimensions
- DE** Ceiling height
 - Max. DE standard suspension = RM + 410
 - Max. DE with track suspension set = RM + 555
- ET** Distance back
- GIM** Inside garage dimension
- BH** Panel height
- RAM** Overall frame dimension = ordering size
 - Min. RAM = RM + 190
 - Max. RAM = 3520
- LF** Structural opening
- V1** Rear operator boom suspension
- W** Total distance back including operator head

Notes:

- Not possible with ThermoFrame sets 1 – 3.
- The clearance for fitting and subsequent operation of the door must be complied with.
- Due to the low threshold height, the ground in front of the garage must be level or sloped to guarantee smooth opening of the wicket door (opening outwards) – see page 46.
- Shortening the top door section or aluminium frame is not possible.
- Not possible as LPU 67 Thermo.

Note:

** Clearance required for fitting doors with leading photocell (see page 42).

SupraMatic P and HT	V1	W
With short boom (K) up to door height 2125	2847	3272
With medium boom (M) up to door height 2375	3097	3522
With long boom (L) up to door height 3000	3772	4197
With special boom length on request		

Clearance for lintel fitting with flush-fitting panel

Without lintel

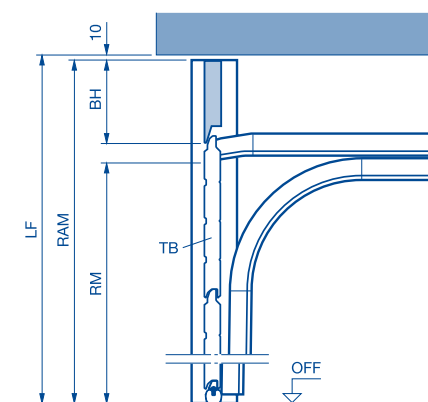

With lintel

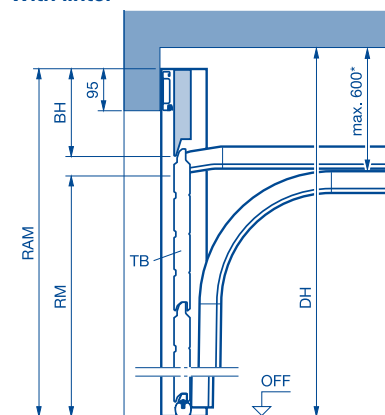

Track application	Panel version
BZ and BL	PU fascia, S-, M- and L-ribbed
	S-panelled on request

- DH** Ceiling height
- RAM** Bottom edge of lintel + 95 mm
- TB** Door leaf
- * Suspension = max. DE standard suspension = RM + 410
Max. DE with track suspension set = RM + 600

RAM LF - 10 mm

Sideroom

Track applications Z, N, L, H

Normal track application, sideroom 90 mm, fixing inside the frame

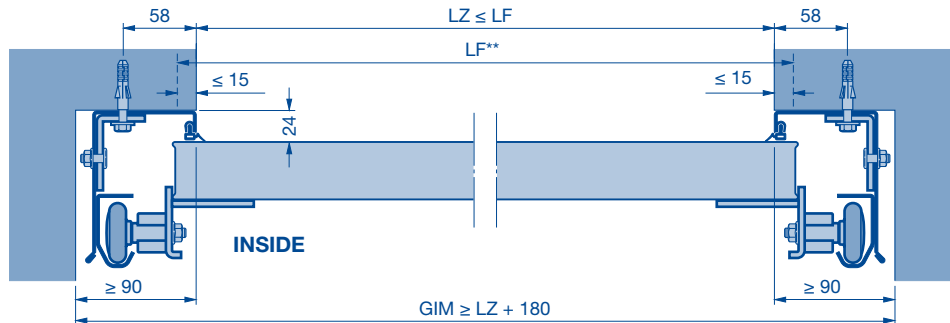

Sideroom less than 75 mm, or without sideroom. Frame fixing using special anchor

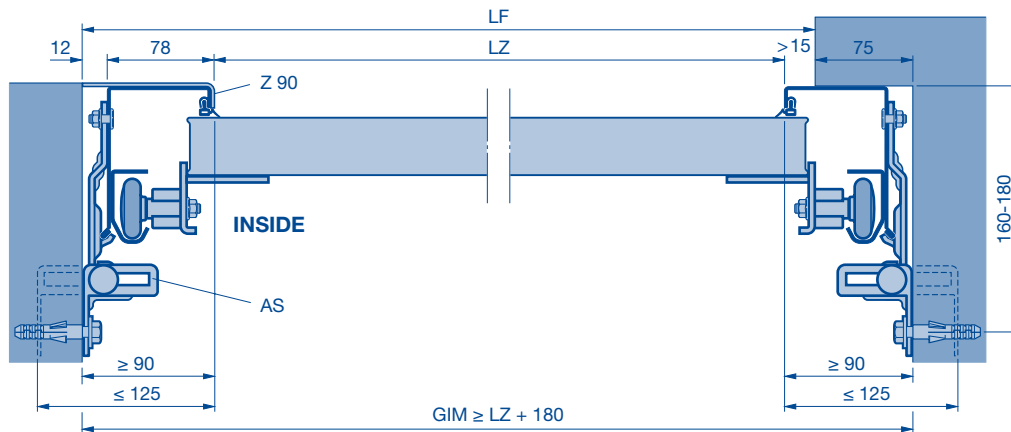

Min. sideroom 75 mm, fixing outside the frame

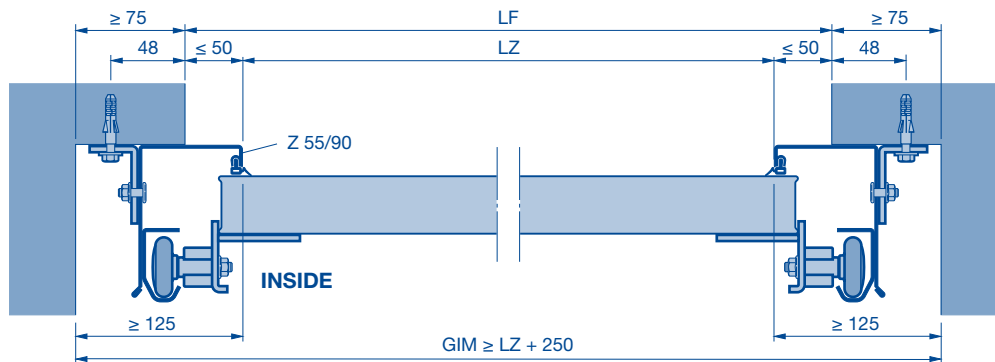

Frame fixing to tube with fixed element using special anchor

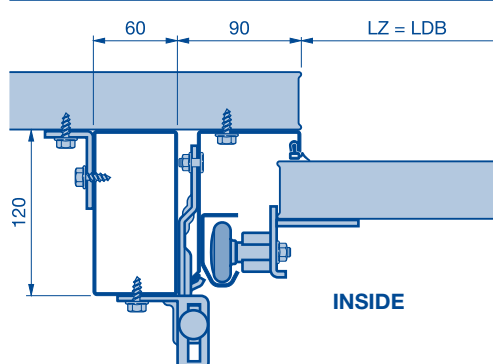

Frame fixing when using a thermal insulation composite system

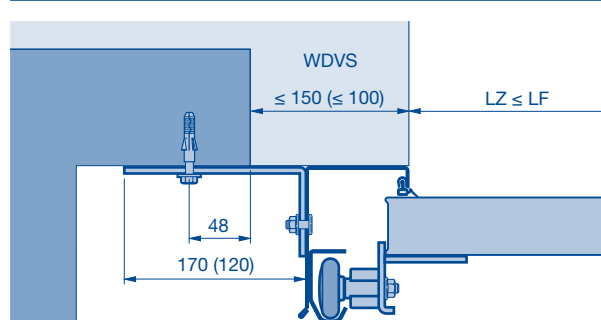

(Legend see page 43)

Sideroom and lintel fitting

Clearance for leading photocell (VL 1/VL 2)

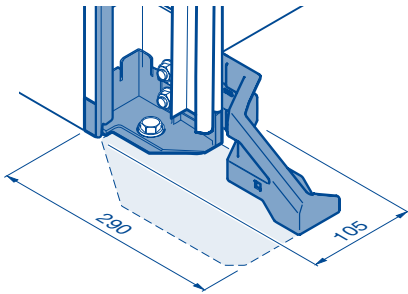

Space for operator rail with folding roller bracket set (ventilation position)

Ceiling height = RM + X

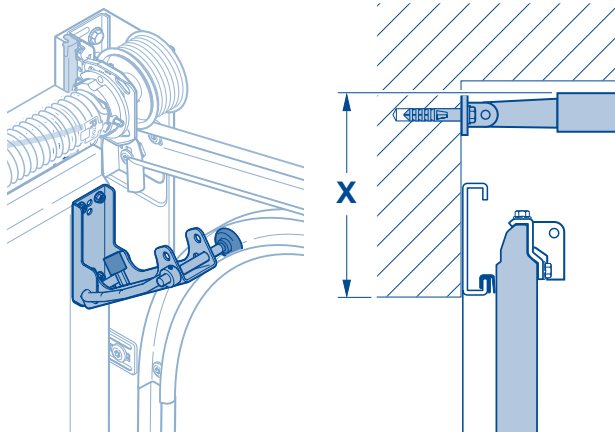

		X	
A		210 – 275	135 – 165
B		210 – 255	115 – 145
C		210 – 275	135 – 165
D		210 – 220	115 – 145

Calculation of the ventilation cross section for folding roller bracket set (in mm²)

- For sectional garage doors with track application N, TH × 0.26 × LZ
- For sectional garage doors with track application L, TH × 0.45 × LZ
- For sectional garage doors with track application Z, TH × 0.45 × LZ

Notes:

- Not possible for track application H, track application BZ, track application BL and doors with wicket door with 4 sections.
- The maximum required headroom must be chosen for doors under thermal load with folding roller bracket.

LZ	Clear frame dimensions
RM	Grid height
TH	Door section height

Sideroom and lintel fitting with ThermoFrame

Track applications Z, N, L, H with ThermoFrame

Normal track application, **sideroom 90 mm**, fixing inside the frame

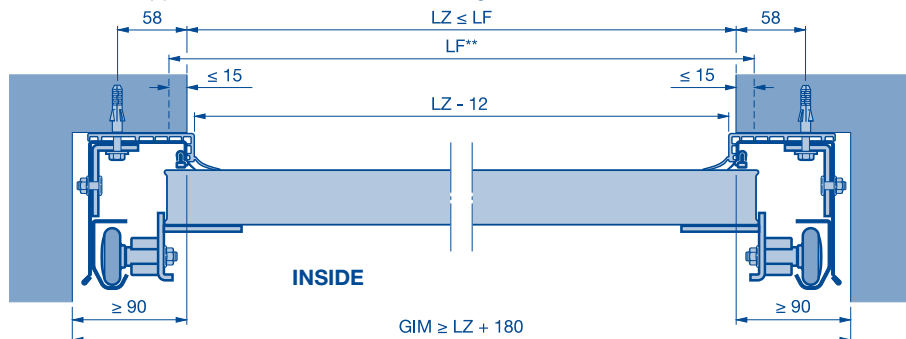

Sideroom less than 75 mm, or without sideroom. Frame fixing using special anchor

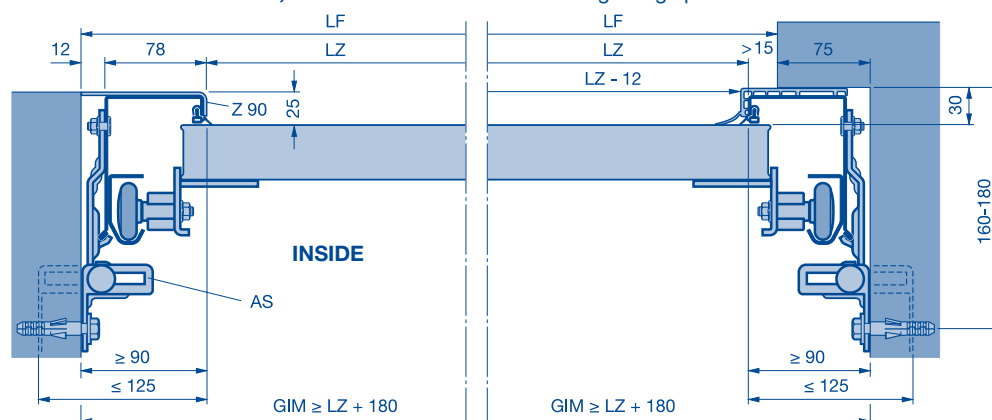

Lintel fitting with ThermoFrame

LPU 42 (sets 1-3)

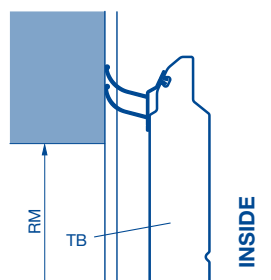

LPU 42 (sets 4-5)

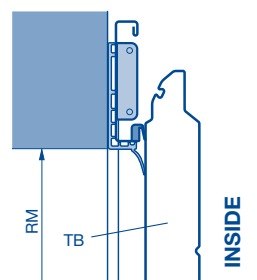

LPU 67 Thermo (sets 6-7)

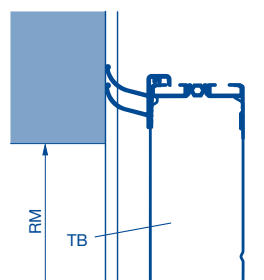

LPU 67 Thermo with aluminium frame (sets 8-9)

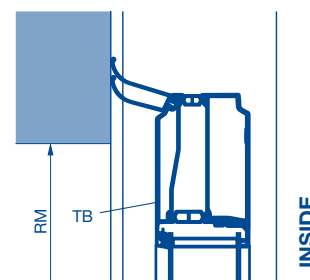

Wicket door with and without rain canopy

Without rain canopy (4 door sections)

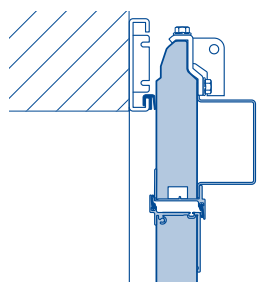

With rain canopy (> 4 door sections)

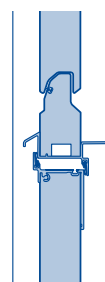

* Min.
** Max.
LZ Clear frame dimensions
LF Structural opening

GIM Inside garage dimension
Z 55 Frame covering 55
Z 90 Frame covering 90 mm
AS Special anchor

RAMB Overall frame width
TB Door leaf
WDVS Thermal insulation composite system

Sideroom

Renovation solution

Fitting in the opening

Fascia frame -95-

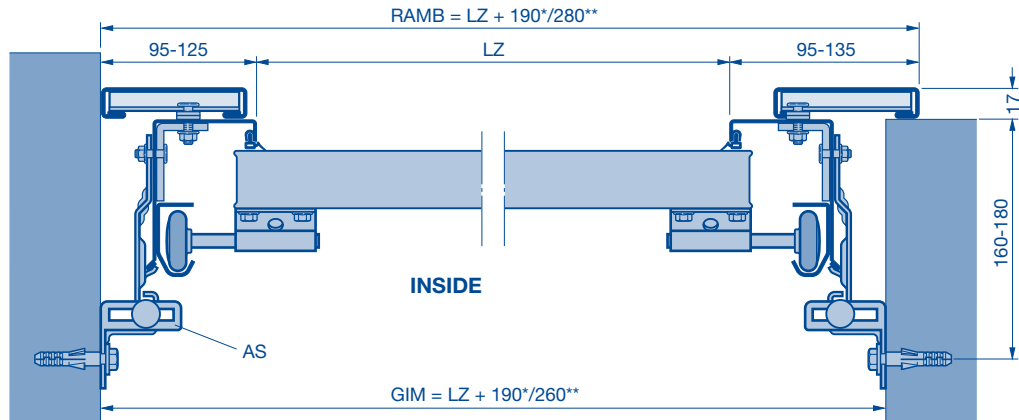

Fitting in front of the reveal

Fascia frame -125-

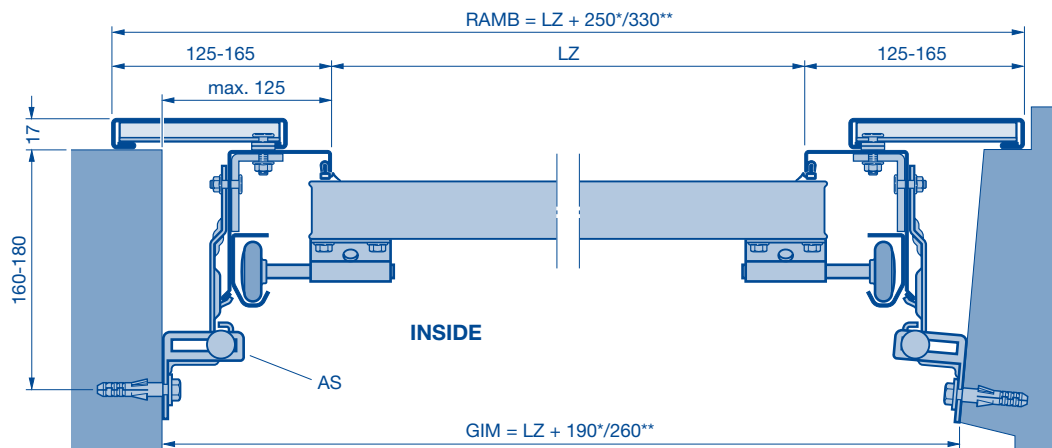

Fitting behind the opening

Retrofit fascia

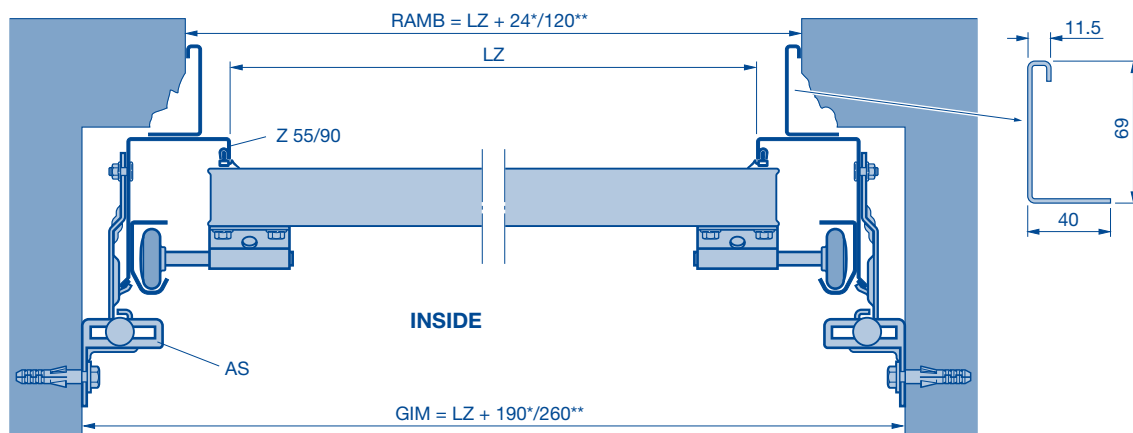

* Min.
 ** Max.
 LZ Clear frame dimensions
 LF Structural opening

GIM Inside garage dimension
 Z 55 Frame covering 55
 Z 90 Frame covering 90
 AS Special anchor

RAMB Overall frame width
 TB Door leaf

Lintel fitting with fascia panels

LTE 42, LPU 42, LPU 67 Thermo

View A
LTE 42, LPU 42

LPU 67 Thermo

View B

View C

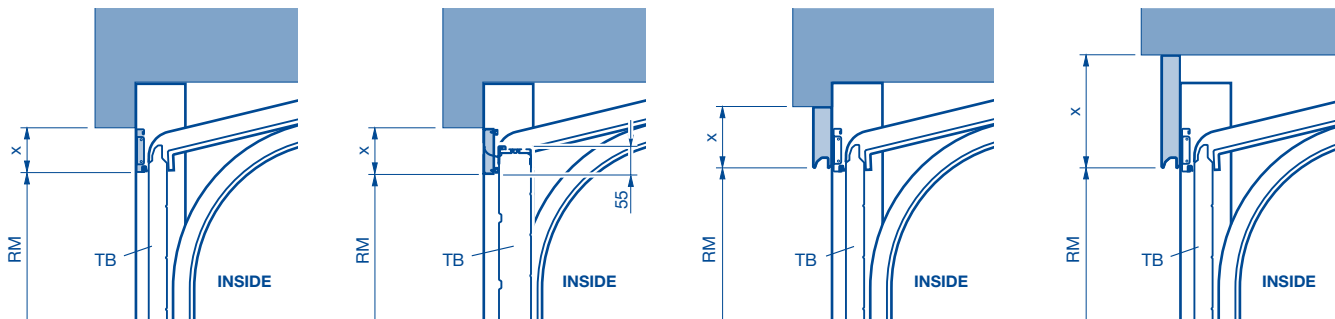

Track application	Panel version	Dimension x		
		View A	View B	View C
Z, N and L	Steel fascia (in scope of delivery)	Up to 100 mm	-	-
	PU fascia, S-/L-ribbed (depth 42 mm)	-	61 – 562 mm	61 – 562 mm
	PU fascia, S-/L-ribbed (depth 67 mm)	-	125 – 562 mm	125 – 562 mm
	PU panel, M-ribbed	-	250 – 562 mm	250 – 562 mm
	PU fascia, S-panelled	-	-	468, 475, 479, 488, 500, 520, 525, 531, 550, 562

LTH 42 (a steel fascia is included in the scope of delivery for LTH 42 doors!)

View A

View B

View C

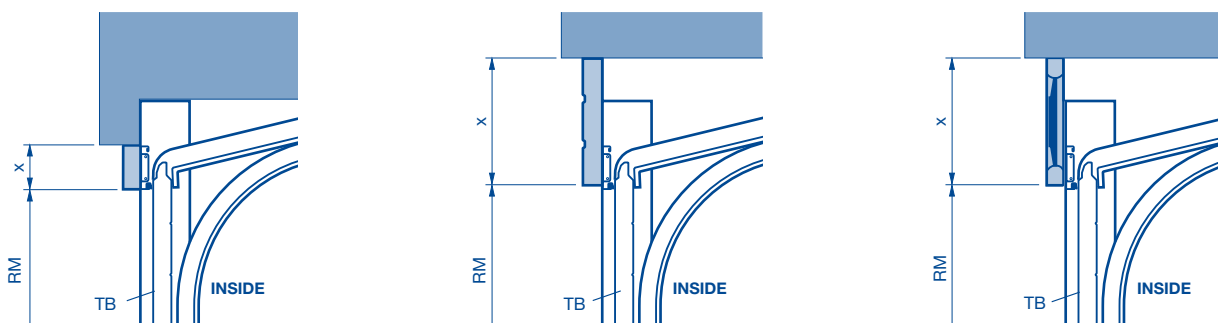

Track application	Panel version	Dimension x		
		View A	View B	View C
N and L	Smooth timber panel	31 – 290 mm	-	-
	Timber panel, S-ribbed	-	146 – 562 mm	-
	Timber panel, V-panelled	-	-	291 – 562 mm

LTE 42, LPU 42

Retrofit fascias

Aluminium frame panel

Fascia frame -95-

Fascia frame -125-

Retrofit fascia

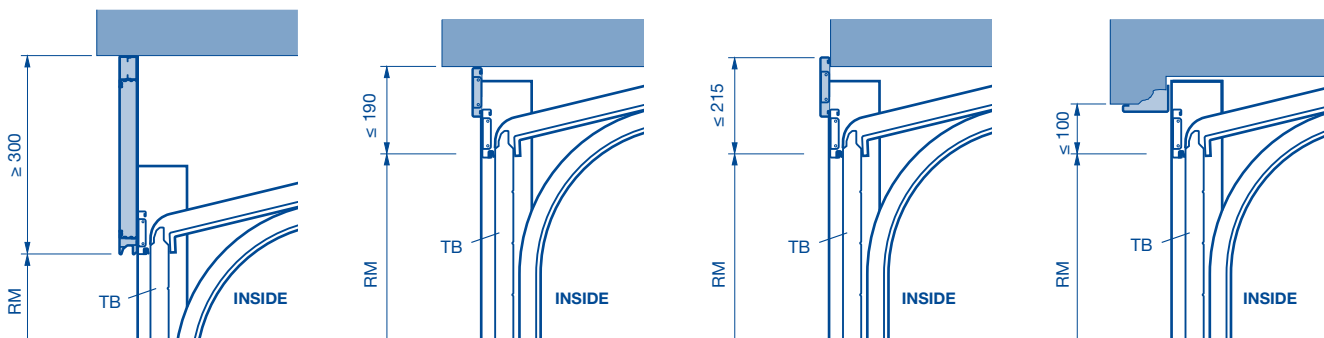

Attention:

Observe the frame's plug-and-screw fitting points in the lintel area, since they are subject to an increased torque with track application N (torsion spring).

TB	Door leaf	LDH	Clear passage height
RM	Grid height	LF	Structural opening

Bottom edge

without wicket door

with wicket door

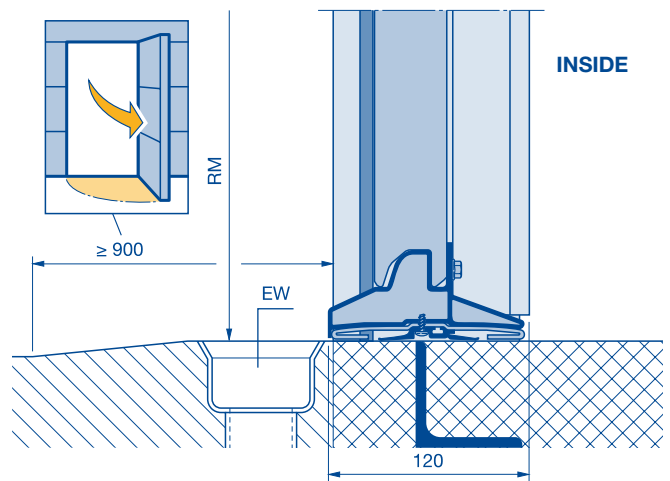
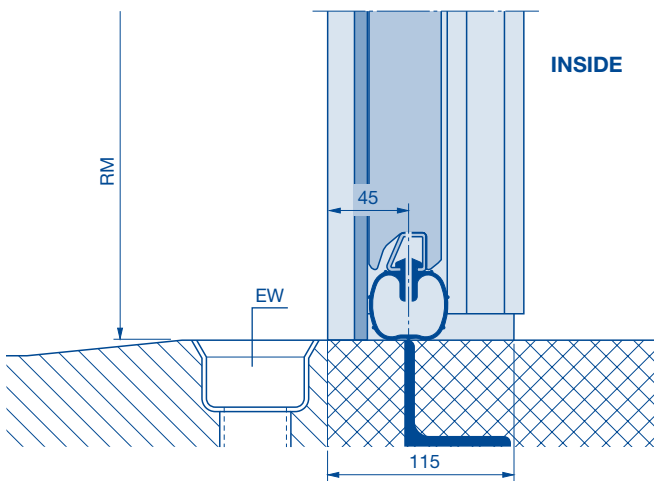
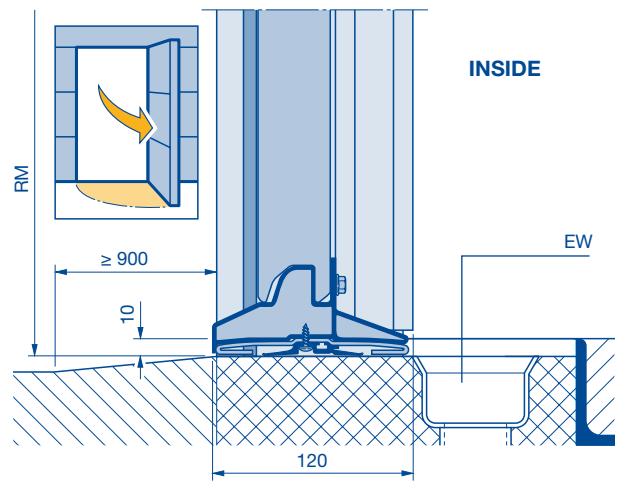
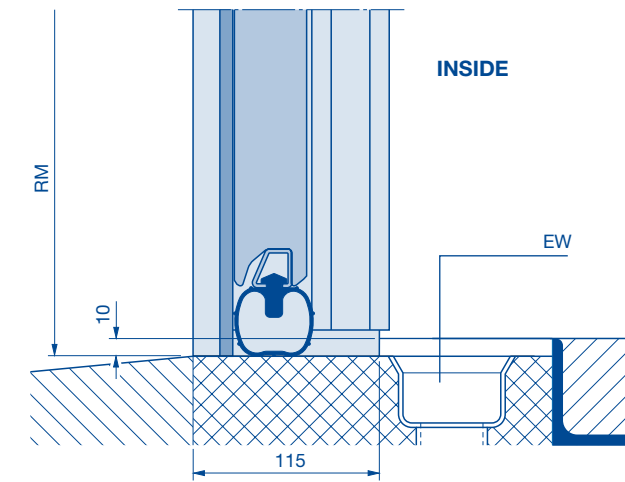
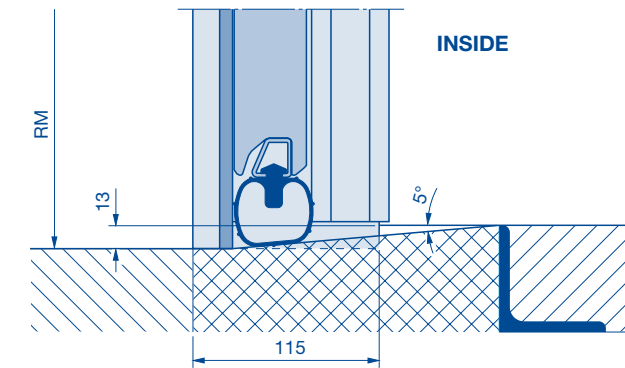

EW Drainage
LDH Clear passage height
RM Grid

Bottom edge

Chamfered height adjustment of the bottom door section (track application SN / SL)

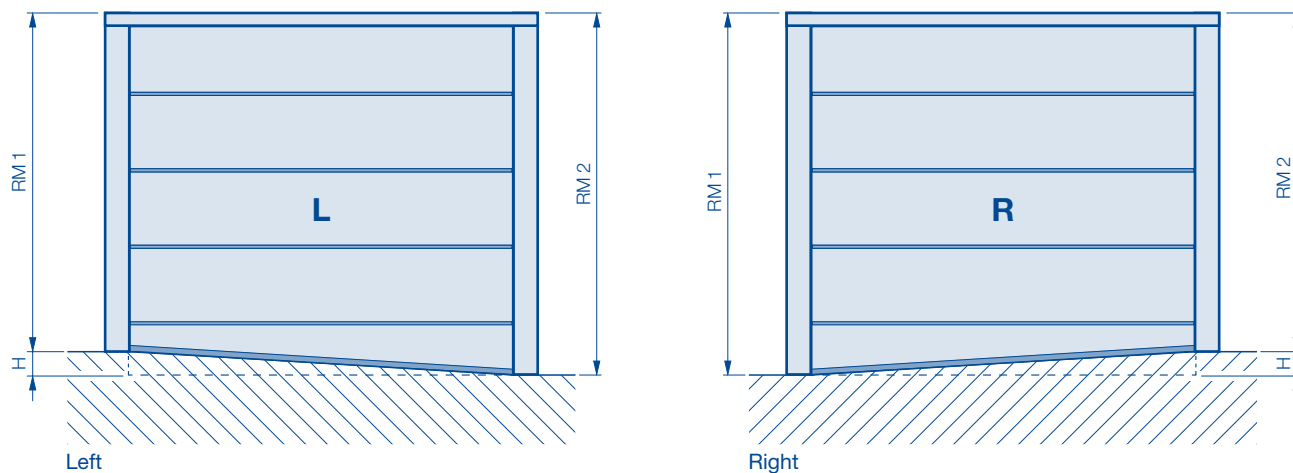

Chamfered bottom section – view of fitting side (from inside)

H = Height difference min. 20 mm / max. 300 mm

Notes:

- Only possible for LPU 42 with track application N or L up to $LZ \leq 6000$ mm!
- Not for versions with wicket door or panelled doors!
- LDH reduced by H.
- Min. RM 1 / RM 2 = 2000 mm.

Recess set (fitting in front of the reveal)

With $N \geq 30$ mm

LDH = RM – 110 mm without operator

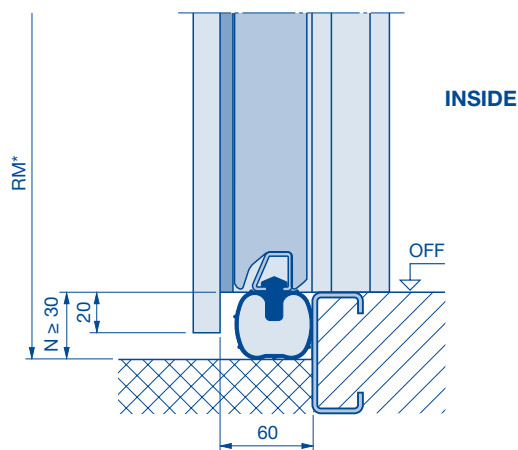

Note:

- * RM (door leaf) = FFL
- RM (frame) = FFL – 25

Wind threshold

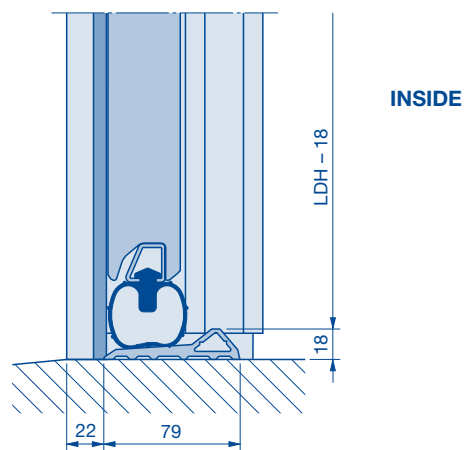

Note:

- Not possible for LPU 42 with wicket door and LPU 67.

LDH	Clear passage height
N	Height difference between interior and exterior garage floor
RM	Grid

Bottom edge LPU 67 Thermo

without wicket door

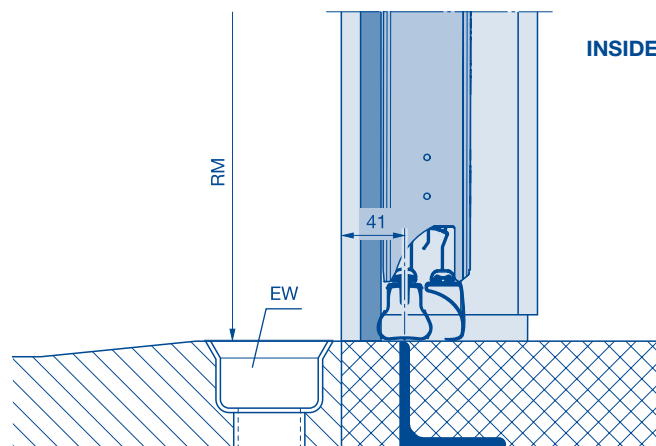
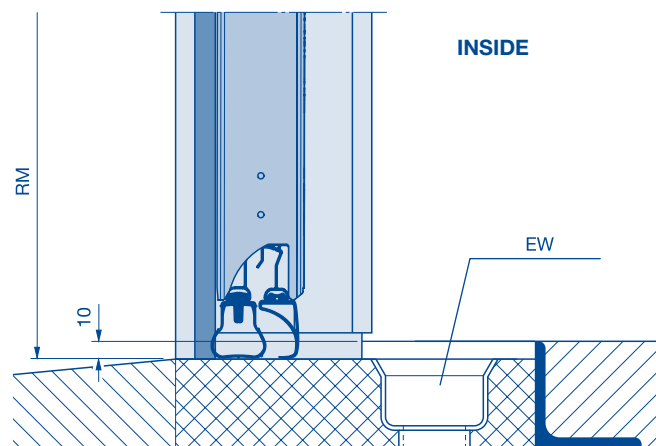
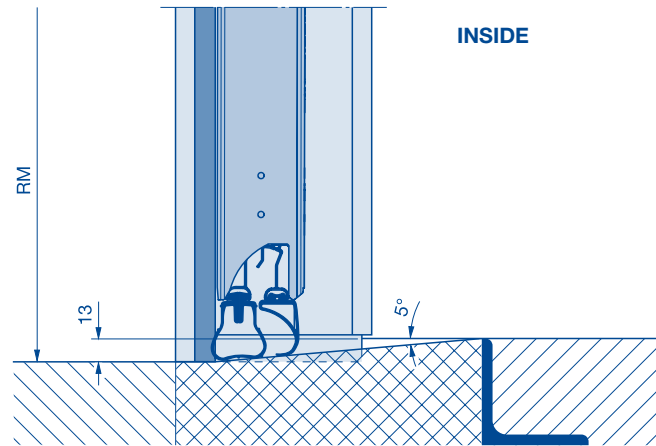

EW Drainage
RM Grid height

Fixed elements

External views

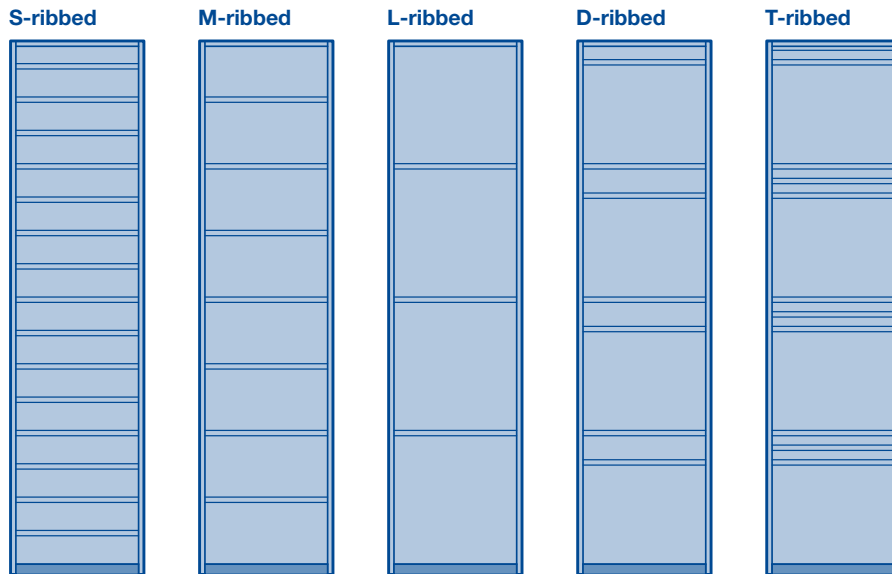

Possible fitting options

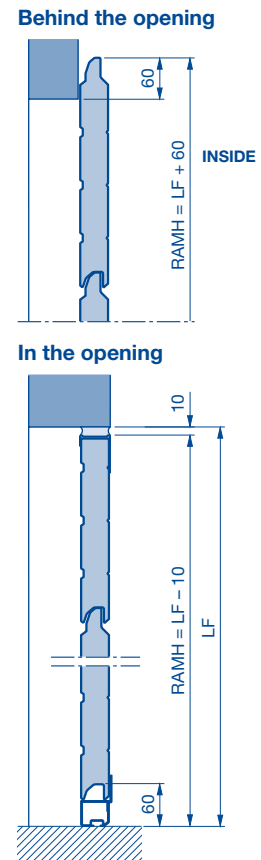

Fitting examples

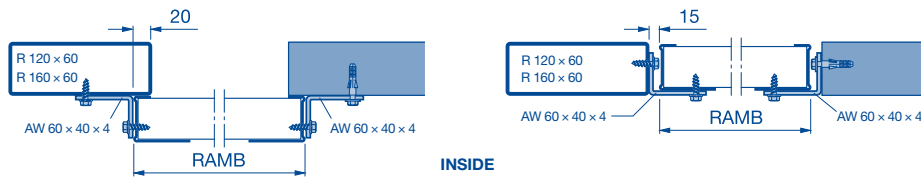

Height table of ribbed versions

B	RM	A	In the opening		Behind the opening
			Min. RAMH	Max. RAMH	RAMH
468	1875	1	100	506	528
468	1875	2	568	974	997
468	1875	3	1036	1442	1466
468	1875	4	1504	1910	1935
468	1875	5	1972	2378	2403
468	1875	6	2440	2846	2872
475	2375	1	100	513	535
475	2375	2	575	988	1010
475	2375	3	1050	1463	1485
475	2375	4	1525	1938	1960
475	2375	5	2000	2413	2435
475	2375	6	2475	2888	2910
479	2875	1	100	517	539
479	2875	2	579	996	1058
479	2875	3	1058	1475	1497
479	2875	4	1537	1954	1976
479	2875	5	2016	2433	2455
479	2875	6	2495	2912	2935
488	1955	1	100	526	548
488	1955	2	588	1014	1037
488	1955	3	1076	1502	1526
488	1955	4	1564	1990	2015
488	1955	5	2052	2478	2503
488	1955	6	2540	2966	2992
500	2000, 2500, 3000	1	100	538	560
500	2000, 2500, 3000	2	600	1038	1060
500	2000, 2500, 3000	3	1100	1538	1560
500	2000, 2500, 3000	4	1600	2038	2060
500	2000, 2500, 3000	5	2100	2538	2560
500	2000, 2500, 3000	6	2600	3038	3060

B	RM	A	In the opening		Behind the opening
			Min. RAMH	Max. RAMH	RAMH
520	2080	1	100	558	580
520	2080	2	620	1078	1100
520	2080	3	1140	1598	1620
520	2080	4	1660	2118	2140
520	2080	5	2180	2638	2660
520	2080	6	2700	3158	3180
525	2625	1	100	563	585
525	2625	2	625	1088	1110
525	2625	3	1150	1613	1635
525	2625	4	1675	2138	2160
525	2625	5	2200	2663	2685
525	2625	6	2725	3188	3210
531	2125	1	100	569	591
531	2125	2	631	1100	1122
531	2125	3	1162	1631	1653
531	2125	4	1693	2162	2185
531	2125	5	2224	2963	2716
531	2125	6	2755	3224	3247
550	2205, 2750	1	100	588	610
550	2205, 2750	2	650	1138	1160
550	2205, 2750	3	1200	1688	1710
550	2205, 2750	4	1750	2238	2260
550	2205, 2750	5	2300	2788	2810
550	2205, 2750	6	2850	3338	3360
562	2250	1	100	600	622
562	2250	2	662	1162	1185
562	2250	3	1224	1724	1747
562	2250	4	1786	2286	2310
562	2250	5	2348	2848	2872
562	2250	6	2910	3410	3435

Note:

RAMB at least 135 mm.

Not possible in Silk-, Sand- and Decograin
A No. of door sections
W Door section height

AW Aluminium bracket
LF Structural opening
RAMB Overall frame width

RAMH Overall frame height
RM Grid height

Side doors NT 60

with corner frame made of aluminium profiles

Standard / special sizes

External views

(The dimensions in the illustrations correspond to the size of the structural opening for 1000 x 2125 mm. Deviations may occur with other door sizes.)

* For possible design elements, see page 19 for L-ribbed doors in Sandgrain and Silkgrain (number of elements based on technical feasibility)

Profile type 1

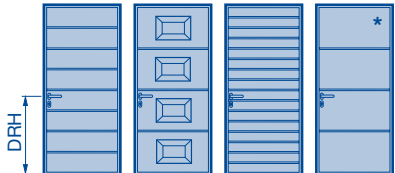

Profile type 2

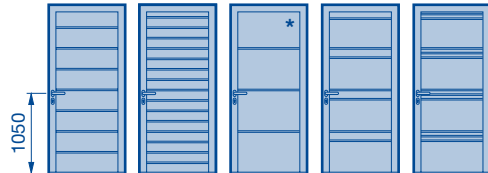

Standard sizes

Profile type 1, only opening inwards, S-, M-, L-ribbed or S-panelled
Fitting: internal fitting

Ordering sizes = BRB	DRH from OFF	W
875 x 2000	955	500
875 x 2125	1010	531
1000 x 2000	955	500
1000 x 2125	1010	531

Profile type 2
S- / M- / L-ribbed
Fitting: internal or external fitting

Ordering sizes = BRB	DRH from OFF	B
875 x 2000	1050	500
875 x 2125	1050	531
1000 x 2000	1050	500
1000 x 2125	1050	531

Special sizes

Profile type 1 internal fitting with S- / M- / L-ribbing						
B	RM	A	BRB*	Min. BRH	Max. BRH	DRH
468	1875	4	550-1284	1800	1935	898
475	2375	4	550-1284	1800	1963	911
479	2875	4	550-1284	1800	1979	917
488	1955	4	550-1284	1800	2015	934
500	2000	4	550-1284	1800	2063	955
520	2080	4	550-1284	1800	2143	990
525	2625	4	550-1284	1800	2163	1000
531	2125	4	550-1284	1800	2187	1010
550	2205/2750	4	550-1284	1800	2263	1043
562	2250	4	550-1284	1804	2311	1064
468	1875	5	550-1284	1990	2403	898
475	2375	5	550-1284	2018	2438	911
479	2875	5	550-1284	2034	2458	917
488	1955	5	550-1284	2070	2500	934
500	2000	5	550-1284	2118	2500	955
520	2080	5	550-1284	2198	2500	990
525	2625	5	550-1284	2218	2500	1000
531	2125	5	550-1284	2242	2500	1010
550	2205/2750	5	550-1284	2318	2500	1043
562	2250	5	550-1284	2366	2500	1064

Profile type 2 internal and external fitting with S- / M- / L-ribbing ***						
W	RM	A	BRB*	Min. BRH**	Max. BRH	DRH
468	1875	4	550-1284	1800	1958	1050
475	2375	4	550-1284	1800	1986	1050
479	2875	4	550-1284	1800	2002	1050
488	1955	4	550-1284	1800	2038	1050
500	2000	4	550-1284	1800	2086	1050
520	2080	4	550-1284	1800	2166	1050
525	2625	4	550-1284	1800	2186	1050
531	2125	4	550-1284	1800	2210	1050
550	2205/2750	4	550-1284	1800	2286	1050
562	2250	4	550-1284	1804	2334	1050
468	1875	5	550-1284	1990	2426	1050
475	2375	5	550-1284	2018	2461	1050
479	2875	5	550-1284	2034	2481	1050
488	1955	5	550-1284	2070	2500	1050
500	2000	5	550-1284	2118	2500	1050
520	2080	5	550-1284	2198	2500	1050
525	2625	5	550-1284	2218	2500	1050
531	2125	5	550-1284	2242	2500	1050
550	2205/2750	5	550-1284	2318	2500	1050
562	2250	5	550-1284	2366	2500	1050

Profile type 1 internal fitting, S-panelled						
B	RM	A	BRB**	Min. BRH*	Max. BRH	DRH
468	1875	4	633-1284	1886	1935	898
475	2375	4	633-1284	1911	1963	911
479	2875	4	633-1284	1925	1979	917
488	1955	4	633-1284	1956	2015	934
500	2000	4	633-1284	1998	2063	955
520	2080	4	633-1284	2068	2143	990
525	2625	4	633-1284	2086	2163	1000
531	2125	4	633-1284	2107	2187	1010
550	2205/2750	4	633-1284	2173	2263	1043
562	2250	4	633-1284	2215	2311	1064
468	1875	5	633-1284	2354	2403	898
475	2375	5	633-1284	2386	2438	911
479	2875	5	633-1284	2404	2458	917
488	1955	5	633-1284	2444	2500	934
500	2000	5	633-1284	2498	2500	955

* Glazing min. BRB: aluminium frame = 550 mm, S window (S-, M-, L-ribbed) = 603 mm, S window (S-panelled) = 633 mm, M window = 828 mm, D window = 888 mm
** BRH < 1800 only with profile type 2 and DRH = BRH / 2 possible on request
*** 3-point locking from BRH > 1900 mm

Note:
Smaller doors possible on request.

A No. of door sections
W Door section height
BRB Nominal width

BRH Nominal height
DRH Lever height
RM Grid height

Side doors NT 60

with corner frame made of aluminium profiles

Standard / special sizes

Profile type 1
(only opening inwards)

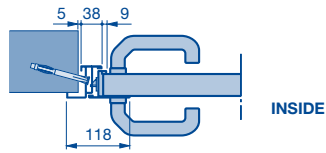

Profile type 2
(opening inwards)

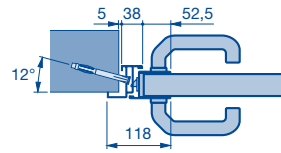

Profile type 2
(opening outwards)

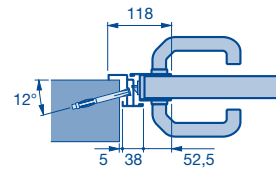

Internal fitting

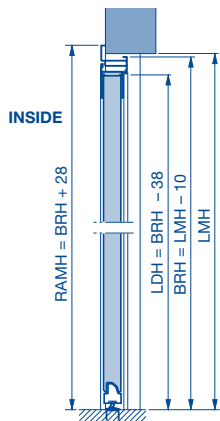

External fitting

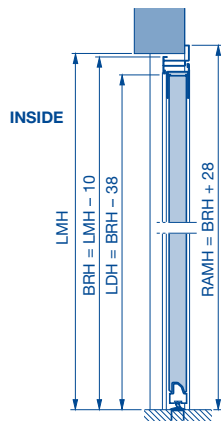

Internal fitting (opening inwards), profile type 1 or 2

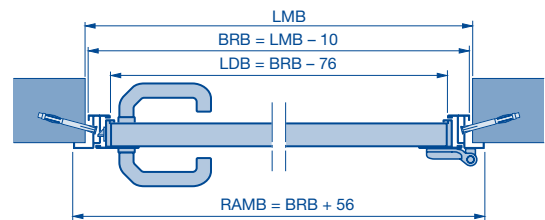
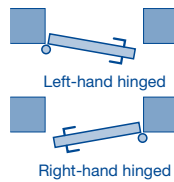

External fitting (opening outwards), profile type 2

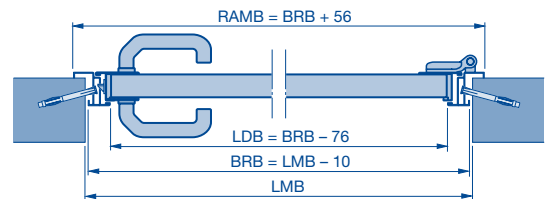
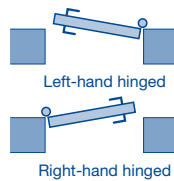

Profile type 1, 2

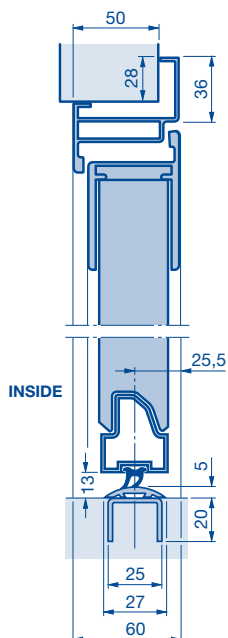

Adjustment from the bottom

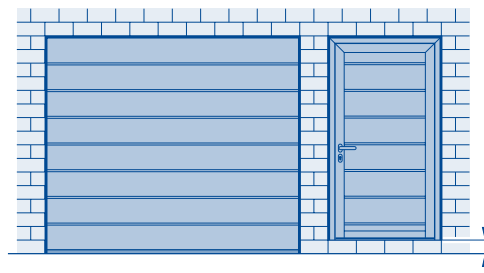

Note:

- Technical inspection required.
- Different design / performance characteristics.
- Not possible with aluminium frames

BRB Nominal width
BRH Nominal height
LDB Clear passage width

LDH Clear passage height
LMB Structural opening width
LMH Structural opening height

RAMB Overall frame width
RAMH Overall frame height

Side doors NT 60

with block frame made of aluminium profiles

Standard sizes

External views

(The dimensions in the illustrations correspond to the size of the structural opening for 1000 × 2125 mm. Deviations may occur with other door sizes.)

* For possible design elements, see page 19 for L-ribbed doors in Sandgrain and Silkgrain (number of elements based on technical feasibility)

Profile type 1

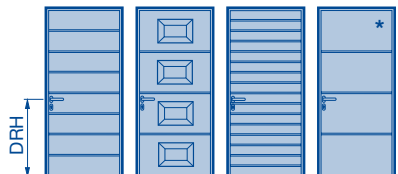

Profile type 2

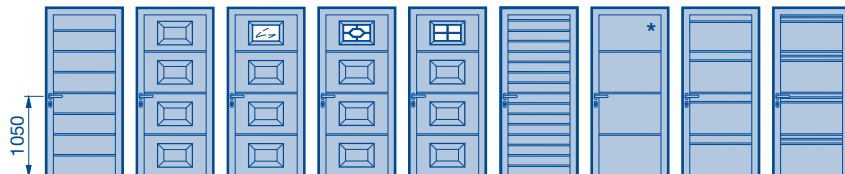

Standard sizes (profile type 1, only opening inwards)

Profile type 1 (fitting behind the opening)

S- / M- / L-ribbed, S-panelled

LF of the opening	Ordering sizes = RAM	DRH from OFF	B
855 – 875 × 1990 – 2000	990 × 2058	955	500
855 – 875 × 2115 – 2125	990 × 2183	1010	531
980 – 1000 × 1990 – 2000	1115 × 2058	955	500
980 – 1000 × 2115 – 2125	1115 × 2183	1010	531

Profile type 2 (fitting behind the opening)

S- / M- / L-ribbed, S-panelled

LF of the opening	Ordering sizes = RAM	DRH from OFF	B
855 – 875 × 1990 – 2000	990 × 2058	1050	500
855 – 875 × 2115 – 2125	990 × 2183	1050	531
980 – 1000 × 1990 – 2000	1115 × 2058	1050	500
980 – 1000 × 2115 – 2125	1115 × 2183	1050	531

Profile type 2 (fitting in the opening)

S- / M- / L-ribbed

LF of the opening	Ordering sizes = RAM	DRH from OFF	W
875 × 2000	855 × 1990	1050	500
875 × 2125	855 × 2115	1050	531
1000 × 2000	980 × 1990	1050	500
1000 × 2125	980 × 2115	1050	531

Note with glazing type D: min. RAM width 935 mm.

(See next page for the legend)

W	Door section height
DRH	Lever height
LF	Structural opening
RAM	Overall frame dimension

Side doors NT 60

with block frame made of aluminium profiles

Standard sizes

Profile type 1

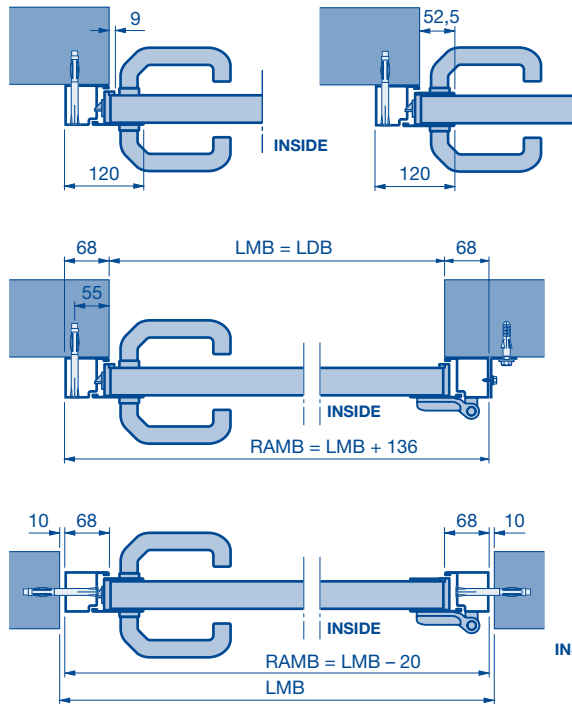

Profile type 2

Profile type 1/2

Profile type 1/2
Panel in front of the side door

Profile type 1/2
Panel over the side door

Profile type 1/2

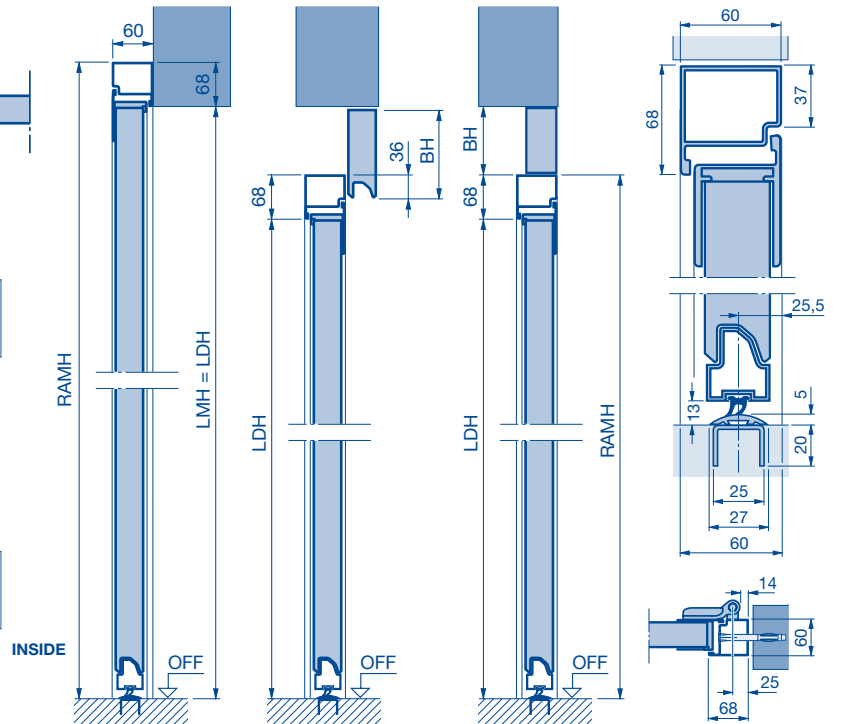

Fitting arrangements

Fitting in the opening

Fitting next to the door, opening inwards or outwards, RH or LH hinged



Fitting in the opening, opening inwards or outwards, RH or LH hinged



Fitting behind the opening

Only opening inwards, RH or LH hinged

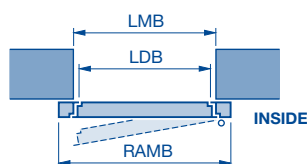

Note:

Dowel holes in the frame must be selected additionally (not standard).

BH Panel height
LDB Clear passage width
LDH Clear passage height
LMB Structural opening width

LMH Structural opening height
RAMB Overall frame width
RAMH Overall frame height

Side doors NT 60

with block frame made of aluminium profiles

Special sizes

External views

(The dimensions in the illustrations correspond to the size of the structural opening for 1000 x 2125 mm. Deviations may occur with other door sizes.)

Profile type 2



Special sizes (profile type 1, only opening inwards)

Profile type 1 (fitting in or behind the opening), S- / M- / L-ribbed						
B	RM	A	RAMB*	Min. RAMH	Max. RAMH	DRH
468	1875	4	550-1330	1800	1955	898
475	2375	4	550-1330	1800	1983	911
479	2875	4	550-1330	1800	1999	917
488	1955	4	550-1330	1800	2035	934
500	2000	4	550-1330	1800	2083	955
520	2080	4	550-1330	1800	2163	990
525	2625	4	550-1330	1800	2183	1000
531	2125	4	550-1330	1800	2207	1010
550	2205/2750	4	550-1330	1800	2283	1043
562	2250	4	550-1330	1825	2331	1064
468	1875	5	550-1330	2011	2423	898
475	2375	5	550-1330	2039	2458	911
479	2875	5	550-1330	2055	2478	917
488	1955	5	550-1330	2091	2523	934
500	2000	5	550-1330	2139	2558	955
520	2080	5	550-1330	2219	2558	990
525	2625	5	550-1330	2239	2558	1000
531	2125	5	550-1330	2263	2558	1010
550	2205/2750	5	550-1330	2339	2558	1043
562	2250	5	550-1330	2387	2558	1064

Profile type 2 (fitting in or behind the opening), S- / M- / L-ribbed ***						
B	RM	A	RAMB*	Min. RAMH**	Max. RAMH	DRH
468	1875	4	550-1330	1800	1979	1050
475	2375	4	550-1330	1800	2007	1050
479	2875	4	550-1330	1800	2023	1050
488	1955	4	550-1330	1800	2059	1050
500	2000	4	550-1330	1800	2107	1050
520	2080	4	550-1330	1800	2187	1050
525	2625	4	550-1330	1800	2207	1050
531	2125	4	550-1330	1800	2231	1050
550	2205/2750	4	550-1330	1800	2307	1050
562	2250	4	550-1330	1825	2355	1050
468	1875	5	550-1330	2011	2447	1050
475	2375	5	550-1330	2039	2482	1050
479	2875	5	550-1330	2055	2502	1050
488	1955	5	550-1330	2091	2547	1050
500	2000	5	550-1330	2139	2558	1050
520	2080	5	550-1330	2219	2558	1050
525	2625	5	550-1330	2239	2558	1050
531	2125	5	550-1330	2263	2558	1050
550	2205/2750	5	550-1330	2339	2558	1050
562	2250	5	550-1330	2387	2558	1050

Profile type 1 (fitting behind the opening), S-panelled						
B	RM	A	RAMB	Min. RAMH	Max. RAMH	DRH
468	1875	4	725-1330	1907	1955	898
475	2375	4	725-1330	1931	1983	911
479	2875	4	725-1330	1945	1999	917
488	1955	4	725-1330	1977	2035	934
500	2000	4	725-1330	2019	2083	955
520	2080	4	725-1330	2089	2163	990
525	2625	4	725-1330	2106	2183	1000
531	2125	4	725-1330	2127	2207	1010
550	2205/2750	4	725-1330	2194	2283	1043
562	2250	4	725-1330	2236	2331	1064
468	1875	5	725-1330	2375	2423	898
475	2375	5	725-1330	2406	2458	911
479	2875	5	725-1330	2424	2478	917
488	1955	5	725-1330	2465	2523	934
500	2000	5	725-1330	2519	2558	955

Profile type 2 (fitting behind the opening), S-panelled						
B	RM	A	RAMB	Min. RAMH	Max. RAMH	DRH
468	1875	4	725-1330	1949	1979	1050
475	2375	4	725-1330	1973	2007	1050
479	2875	4	725-1330	1987	2023	1050
488	1955	4	725-1330	2019	2059	1050
500	2000	4	725-1330	2061	2107	1050
520	2080	4	725-1330	2131	2187	1050
525	2625	4	725-1330	2148	2207	1050
531	2125	4	725-1330	2169	2231	1050
550	2205/2750	4	725-1330	2236	2307	1050
562	2250	4	725-1330	2278	2355	1050
468	1875	5	725-1330	2417	2447	1050
475	2375	5	725-1330	2448	2482	1050
479	2875	5	725-1330	2466	2502	1050
488	1955	5	725-1330	2507	2547	1050

- * Glazing type D: min RAMB = 935 mm or panel glazing type M: min RAMB = 875 mm
- ** RAMH < 1800 only with profile type 2 and DRH = RAMH/2 possible on request
- *** 3-point locking from RAMH > 1910 mm

Note:
Smaller doors possible on request.

A No. of door sections
W Door section height
DRH Lever height
RAMB Overall frame width

RAMH Overall frame height
RM Grid height

Side doors NT 60

with block frame made of aluminium profiles

Special sizes

Fitting next to the door, opening outwards, RH or LH hinged

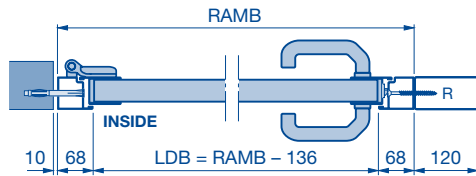

Fitting next to the door, opening inwards, RH or LH hinged

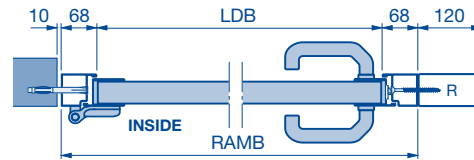

Fitting in the opening, opening inwards or outwards, RH or LH hinged

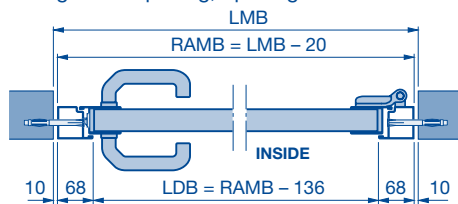

Fitting behind the opening, opening inwards, RH or LH hinged

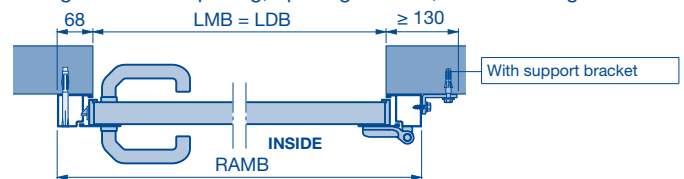

Fitting behind the opening

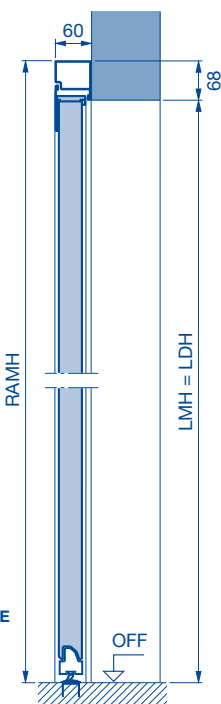

Fitting in the opening

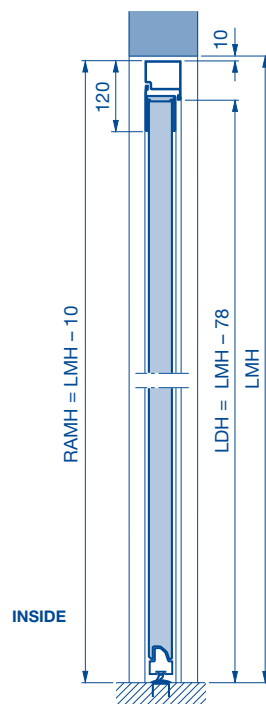

Adjustment from the bottom

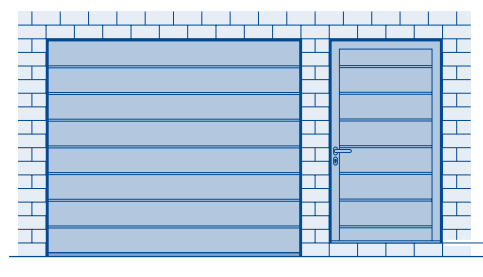

Note:

- Technical inspection required.
- Different design / performance characteristics.
- Not possible with aluminium frames

Note:

Dowel holes in the frame must be selected additionally (not standard).

DRH Lever height	LMH Structural opening height
LDB Clear passage width	R Box section
LDH Clear passage height	RAMB Overall frame width
LMB Structural opening width	RAMH Overall frame height

Side doors NT 60

Double-leaf side doors with block frame made of aluminium profiles

Fitting in the opening, profile type 2, opening inwards or outwards, RH or LH hinged

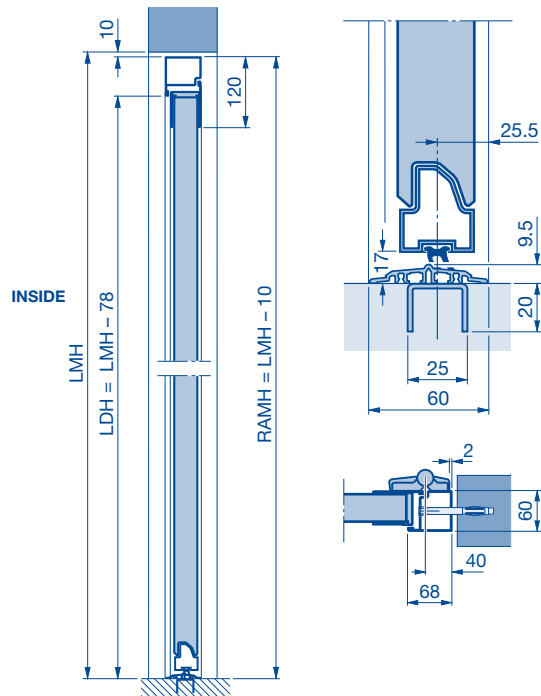
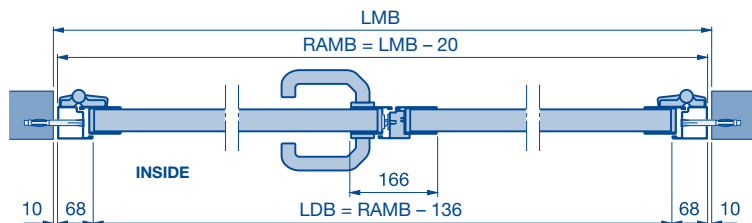

Note:

- The ground must be level or sloped to guarantee smooth opening of the double-leaf side door.
- Asymmetric division possible from $RAMB \leq 2000$ mm.
- With asymmetric division, the clear passage width for the traffic leaf is always 870 mm.
- No RC 2 possible with side door "opening inwards"!

Fitting arrangements

Fitting in the opening, opening outwards or inwards, right-hand hinged

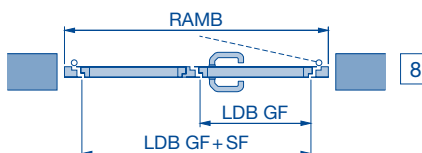
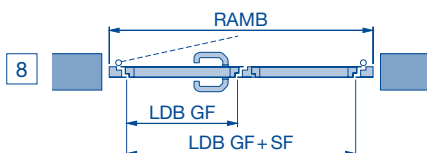

Fitting in the opening, opening outwards or inwards, left-hand hinged

Special sizes

Profile type 2 (fitting in the opening), S- / M- / L-ribbed						
B	RM	A	RAMB	Min. RAMH	Max. RAMH	DRH
468	1875	4	1200-2500	1960	1979	1050
475	2375				2007	
479	2875				2023	
488	1955				2059	
500	2000				2107	
520	2080				2187	
525	2625				2207	
531	2125				2231	
550	2205/2750				2307	
562	2250				2355	
468	1875	5	1200-2500	2011	2447	1050
475	2375			2039	2482	
479	2875			2055	2502	
488	1955			2091	2547	
500	2000			2139	2558	
520	2080			2219	2558	
525	2625			2239	2558	
531	2125			2263	2558	
550	2205/2750			2339	2558	
562	2250			2387	2558	

A No. of door sections
W Door section height
DRH Lever height
LDB Clear passage width
LDH Clear passage height

LMB Structural opening width
LMH Structural opening height
Traffic leaf Traffic leaf

SF Fixed leaf
RAM Overall frame dimension
RAMB Overall frame width
RAMH Overall frame height
RM Grid height

Side doors NT 60 ART 42

with corner frame made of aluminium profiles

External views

(The dimensions in the illustrations correspond to the size of the structural opening for 1000 × 2125 mm. Deviations may occur with other door sizes.)



Corner frame

W	RM	Internal or external fitting				
		A	BRB*	Min. BRH	Max. BRH	DRH
468	1875	4	550-1284	1800	1958	1050
475	2375	4	550-1284	1800	1986	1050
479	2875	4	550-1284	1800	2002	1050
488	1955	4	550-1284	1800	2038	1050
500	2000	4	550-1284	1800	2086	1050
520	2080	4	550-1284	1800	2166	1050
525	2625	4	550-1284	1800	5186	1050
531	2125	4	550-1284	1800	2210	1050
550	2205/2750	4	550-1284	1800	2286	1050
562	2250	4	550-1284	1804	2334	1050
468	1875	5	550-1284	1990	2426	1050
475	2375	5	550-1284	2018	2461	1050
479	2875	5	550-1284	2034	2481	1050
488	1955	5	550-1284	2070	2500	1050
500	2000	5	550-1284	2118	2500	1050
520	2080	5	550-1284	2198	2500	1050
525	2625	5	550-1284	2218	2500	1050
531	2125	5	550-1284	2242	2500	1050
550	2205/2750	5	550-1284	2318	2500	1050
562	2250	5	550-1284	2366	2500	1050

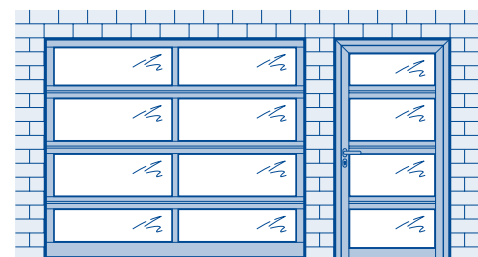

Note:

- NT 60 ART 42: Due to the different heights of the door bottom profiles, a matching appearance with sectional door ART 42 is only possible to a limited extent.
- Different design / performance characteristics for NT 60 ART 42
- Not possible with equal height infills / openings

A No. of door sections
W Door section height
BRB Nominal width

BRH Nominal height
DRH Lever height
RM Grid height

Side doors NT 60 ART 42

with corner frame made of aluminium profiles

Profile type 2
(opening inwards)

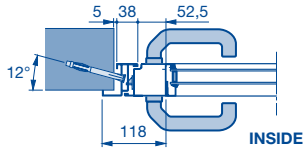

Profile type 2
(opening outwards)

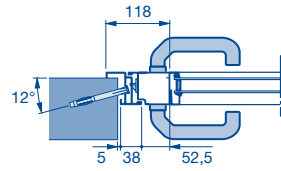

Internal fitting

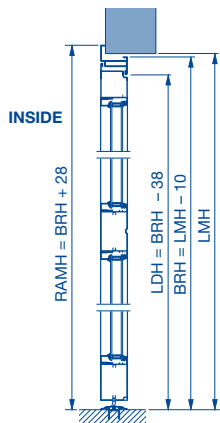

External fitting

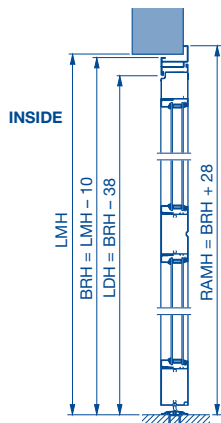

Internal fitting (opening inwards), profile type 1 or 2

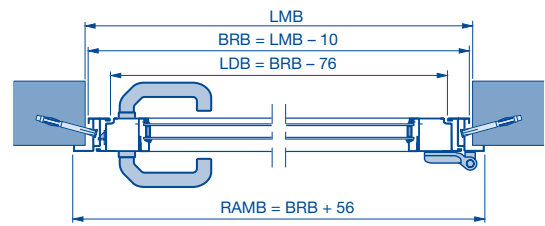
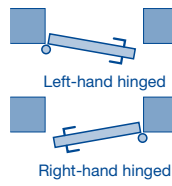

External fitting (opening outwards), profile type 2

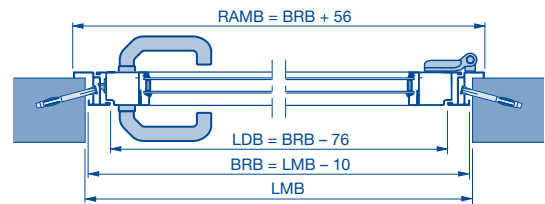
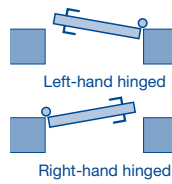

Profile type 1, 2

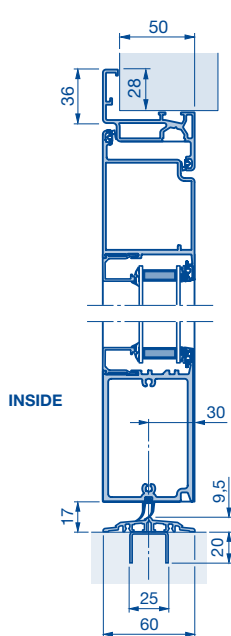

BRB Nominal width
BRH Nominal height
LDB Clear passage width

LDH Clear passage height
LMB Structural opening width
LMH Structural opening height

RAMB Overall frame width
RAMH Overall frame height

Side doors NT 60 ART 42

with block frame made of aluminium profiles

External views

(The dimensions in the illustrations correspond to the size of the structural opening for 1000 x 2125 mm. Deviations may occur with other door sizes.)



Block frame

W	RM	A	Internal or external fitting			DRH
			RAMB*	Min. RAMH	Max. RAMH	
468	1875	4	550-1330	1800	1979	1050
475	2375	4	550-1330	1800	2007	1050
479	2875	4	550-1330	1800	2023	1050
488	1955	4	550-1330	1800	2059	1050
500	2000	4	550-1330	1800	2107	1050
520	2080	4	550-1330	1800	2187	1050
525	2625	4	550-1330	1800	2207	1050
531	2125	4	550-1330	1800	2231	1050
550	2205/2750	4	550-1330	1800	2307	1050
562	2250	4	550-1330	1825	2355	1050
468	1875	5	550-1330	2011	2447	1050
475	2375	5	550-1330	2039	2482	1050
479	2875	5	550-1330	2055	2502	1050
488	1955	5	550-1330	2091	2547	1050
500	2000	5	550-1330	2139	2558	1050
520	2080	5	550-1330	2219	2558	1050
525	2625	5	550-1330	2239	2558	1050
531	2125	5	550-1330	2263	2558	1050
550	2205/2750	5	550-1330	2339	2558	1050
562	2250	5	550-1330	2387	2558	1050

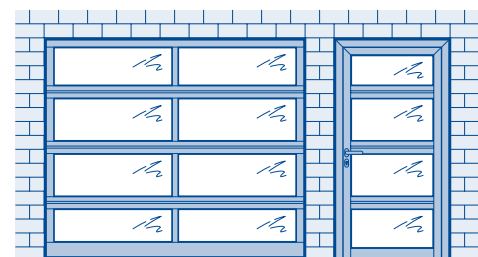

Note:

- NT 60 ART 42: Due to the different heights of the door bottom profiles, a matching appearance with sectional door ART 42 is only possible to a limited extent.
- Different design / performance characteristics for NT 60 ART 42
- Not possible with equal height infills / openings

A No. of door sections
W Door section height
BRB Nominal width

BRH Nominal height
DRH Lever height
RM Grid height

Side doors NT 60 ART 42

with block frame made of aluminium profiles

Fitting next to the door, opening outwards, RH or LH hinged

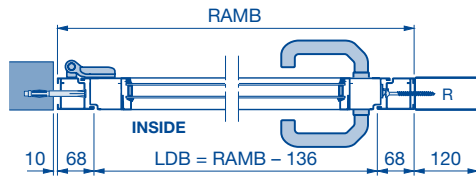

Fitting next to the door, opening inwards, RH or LH hinged

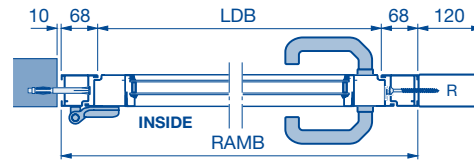

Fitting in the opening, opening inwards or outwards, RH or LH hinged

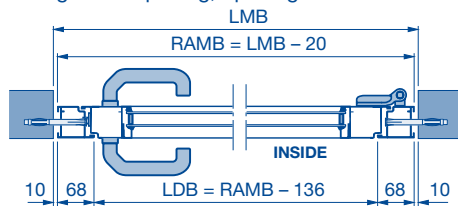

Fitting behind the opening, opening inwards, RH or LH hinged

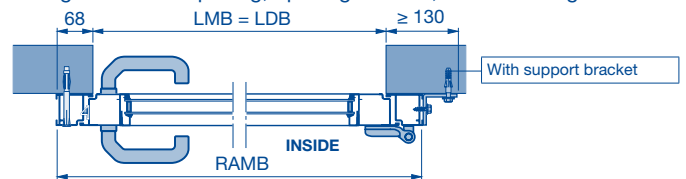

Fitting behind the opening

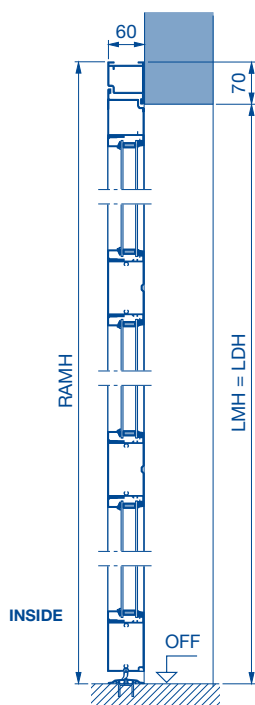

Fitting in the opening

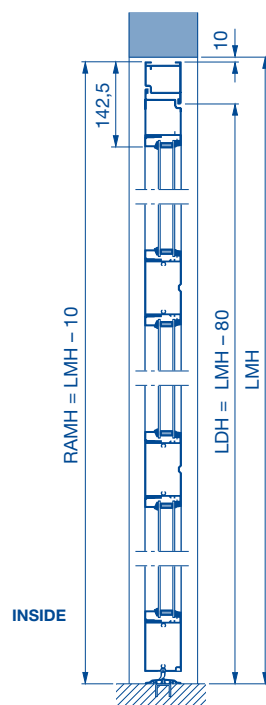

Profile type 1, 2

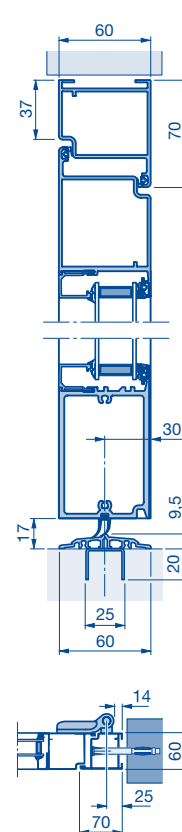

Profile type 2

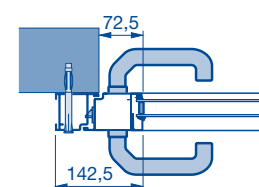

Note:

Dowel holes in the frame must be selected additionally (not standard).

DRH Lever height	LMH Structural opening height
LDB Clear passage width	R Box section
LDH Clear passage height	RAMB Overall frame width
LMB Structural opening width	RAMH Overall frame height

Hinged garage door DFT 42

Double-leaf garage door with block frame made of aluminium profiles

Fitting in the opening, opening outwards, RH or LH hinged

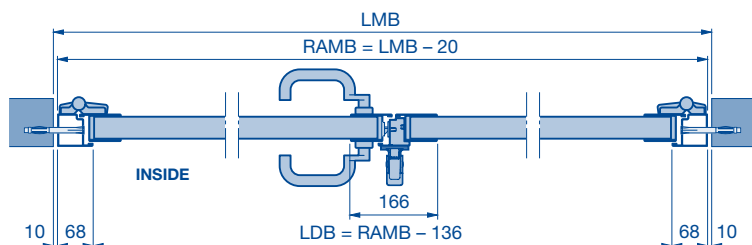

- Max. size 3000 x 2500 mm
- Min. size 1330 x 1960 mm

Note:

- The ground must be level or sloped to guarantee smooth opening of the double-leaf side garage door.
- Asymmetric division possible from $RAMB \leq 2000$ mm.
- With asymmetric division, the clear passage width for the traffic leaf is always 870 mm.

Fitting arrangements

Fitting in the opening, opening outwards or inwards, right-hand hinged

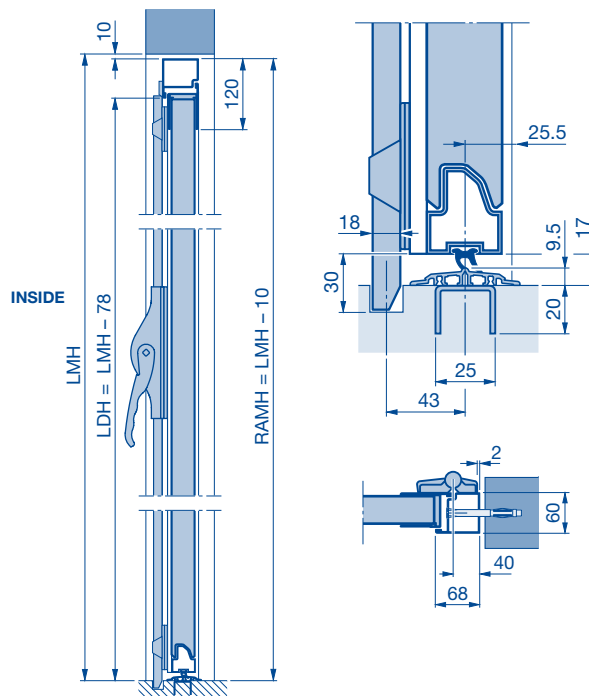
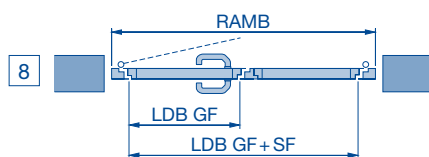

Special sizes

DFT 42 (fitting in the opening), S- / M- / L-ribbed									
W	RM	A	RAMB	Min. RAMH	Max. RAMH	DRH			
468	1875	4	1200-2500	1960	1979	1050			
475	2375				2007				
479	2875				2023				
488	1955				2059				
500	2000				2107				
520	2080				2187				
525	2625				2207				
531	2125				2231				
550	2205/2750				2307				
562	2250				2355				
468	1875				5		1200-2500	2011	2447
475	2375							2039	2482
479	2875	2055	2500						
488	1955	2091	2500						
500	2000	2139	2500						
520	2080	2219	2500						
525	2625	2239	2500						
531	2125	2263	2500						
550	2205/2750	2339	2500						
562	2250	2387	2500						

A No. of door sections	LMB Structural opening width	SF Fixed leaf
W Door section height	LMH Structural opening height	RAM Overall frame dimension
DRH Lever height	Traffic leaf Traffic leaf	RAMB Overall frame width
LDB Clear passage width	leaf	RAMH Overall frame height
LDH Clear passage height		RM Grid height

Timber side doors NT 60

Standard / special sizes

External views

(The dimensions in the illustrations correspond to the size of the structural opening for 1000 × 2125 mm.
Deviations may occur with other door sizes.)

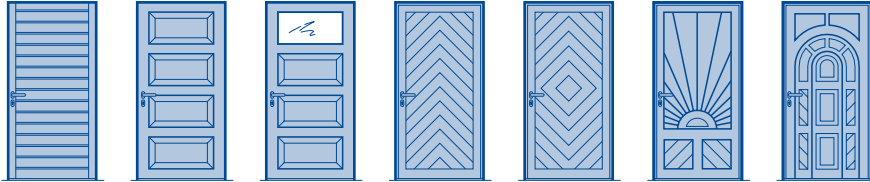

S-ribbed or V-panelled version			
Structural opening	Ordering sizes = RAM	Lever handle height from FFL	Spacing
Standard sizes	–	–	–
855–875 × 2115–2125	1005–2190	1050	133
980–1000 × 2115–2125	1130–2190	1050	133
Special sizes	990–1250 × 1940–2315	1050	–

Style version		
Structural opening	Ordering sizes = RAM	Lever handle height from FFL
Standard sizes	–	–
980–1000 × 2115–2125	1130–2190	1050
Special sizes	1130–1250 × 1940–2315	1050

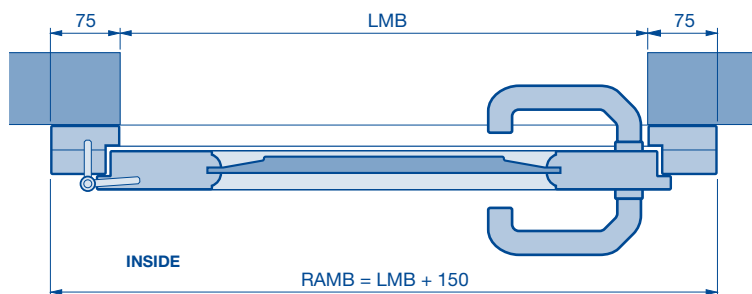
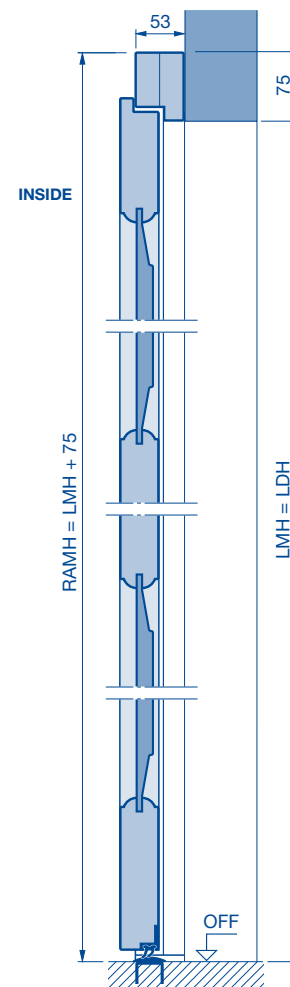

LDH Clear passage height
LMB Structural opening width
LMH Structural opening height
RAMB Overall frame width

RAMH Overall frame height

Notes

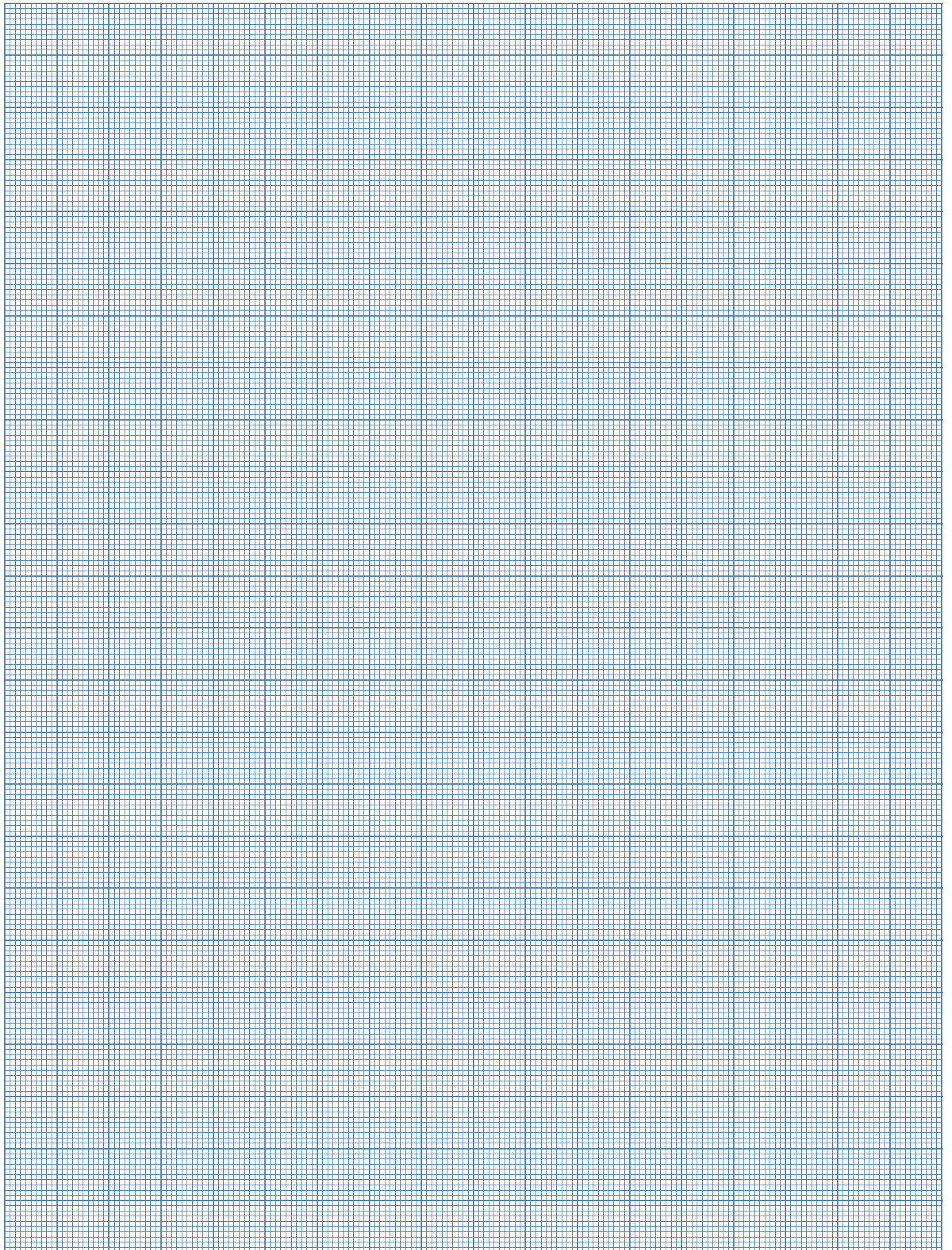

Hörmann: Quality without Compromise



Hörmann KG Amshausen, Germany



Hörmann KG Antriebstechnik, Germany



Hörmann KG Brandis, Germany



Hörmann KG Brockhagen, Germany



Hörmann KG Dissen, Germany



Hörmann KG Eckelhausen, Germany



Hörmann KG Freisen, Germany



Hörmann KG Ichttershausen, Germany



Hörmann KG Werne, Germany



Hörmann Alkmaar B.V., Netherlands



Hörmann Legnica Sp. z o.o., Poland



Hörmann Beijing, China



Hörmann Tianjin, China



Hörmann LLC, Montgomery IL, USA



Hörmann Flexon LLC, Burgettstown PA, USA



Shakti Hörmann Pvt. Ltd., India

Hörmann is the only manufacturer worldwide that offers you a complete range of all major building products from one source. We manufacture in highly-specialised factories using the latest production technologies. The close-meshed network of sales and service companies throughout Europe, and activities in the USA and Asia, make Hörmann your strong partner for first-class building products, offering “Quality without Compromise”.

GARAGE DOORS
OPERATORS
INDUSTRIAL DOORS
LOADING EQUIPMENT
HINGED DOORS
DOOR FRAMES

HÖRMANN